

SP1555 Series 120A for V_{BUS}

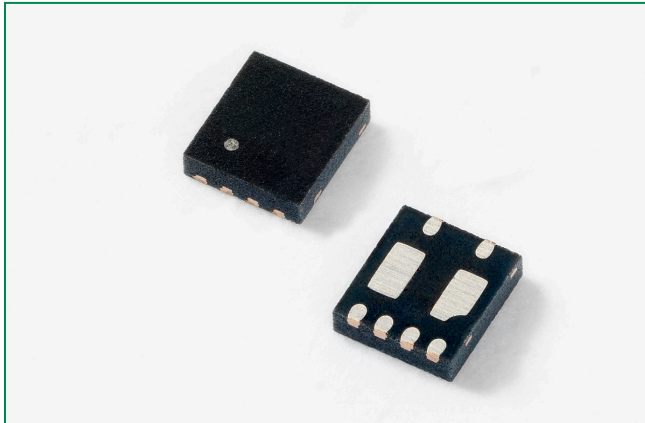

Description

The SP1555 integrates a 15V TVS diode to provide lightning surge protection for the USB V_{BUS} pin up to 120A ($t_p=8/20\mu s$) per the IEC61000-4-5 2nd edition standard. The SP1555 provides superior protection for current intensive applications such as fast charging peripherals.

The SP1555 comes in a space saving 2.0x1.8mm μ DFN package with a typical height of 0.55mm making it an ideal solution for smart phones, tablets, and other portable electronics.

Pinout

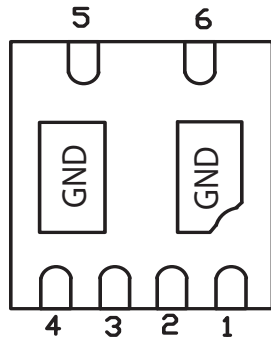

Bottom View

Features

- ESD, IEC 61000-4-2, $\pm 30kV$ contact, $\pm 30kV$ air
- EFT, IEC 61000-4-4, 80A ($t_p=5/50ns$)
- Surge, IEC 61000-4-5 2nd edition, 120A ($t_p=8/20\mu s$)
- Protection for V_{BUS} operating up to 15V
- Benchmark setting protection
- High current handling capability for fast charging applications
- Moisture Sensitivity Level (MSL:1)
- Lead-free and RoHS compliant

Functional Block Diagram

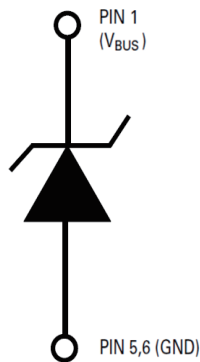

Applications

- Protection for the V_{BUS} circuit on USB2.0 Fast Charging

Life Support Note:
Not Intended for Use in Life Support or Life Saving Applications
The products shown herein are not designed for use in life sustaining or life saving applications unless otherwise expressly indicated.

©2016 Littelfuse, Inc.
Specifications are subject to change without notice.
Revision: 09/30/16

Absolute Maximum Ratings

Symbol	Parameter	Value	Units
I_{PP} (Pin 1)	Peak Current ($t_p=8/20\mu s$)	120	A
T_{OP}	Operating Temperature	-40 to 125	°C
T_{STOR}	Storage Temperature	-55 to 150	°C

CAUTION: Stresses at or above those listed in "Absolute Maximum Ratings" may cause permanent damage to the device. This is a stress only rating and operation of the device at these or any other conditions above those indicated in the operational sections of this specification is not implied. Also due to variations in test equipment stresses shown above are averages.

Electrical Characteristics ($T_{OP}=25^\circ C$)

Parameter	Symbol	Test Conditions	Min	Typ	Max	Units
USB V_{BUS} (Pin 1)						
Reverse Standoff Voltage	V_{RWM}	Pin 1 to GND			15	V
Reverse Breakdown Voltage	V_{BR}	$I_T=1mA$, Pin 1 to GND	17.5	18.8	20.1	V
Reverse Leakage Current	I_{LEAK}	$V_R=15V$, Pin 1 to GND		0.05	1	μA
Forward Voltage	V_F	$I_F=10mA$, GND to Pin 1	0.6	0.7	1.0	V
Clamp Voltage ¹	V_C	$I_{PP}=30A$, $t_p=8/20\mu s$, Fwd		21.5		V
		$I_{PP}=100A$, $t_p=8/20\mu s$, Fwd		27.5		V
		$I_{PP}=120A$, $t_p=8/20\mu s$, Fwd		29.5		V
ESD Withstand Voltage ¹	V_{ESD}	IEC 61000-4-2 (Contact)	± 30			kV
		IEC 61000-4-2 (Air)	± 30			kV
Diode Capacitance ¹	C_D	Reverse Bias=0V, f=1MHz		800		pF

Note: 1 Parameter is guaranteed by design and/or device characterization.

Capacitance vs. Reverse Bias (Pin1 to GND)

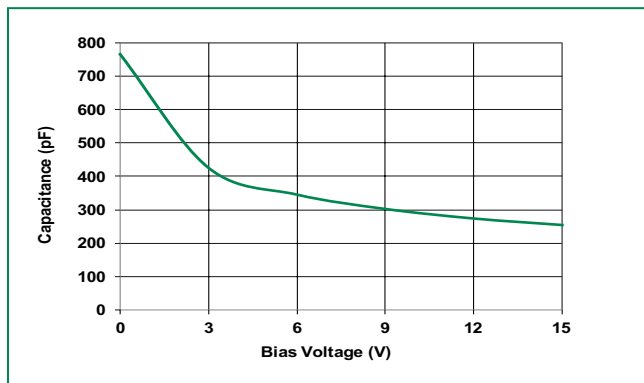

Clamping Voltage vs I_{PP}

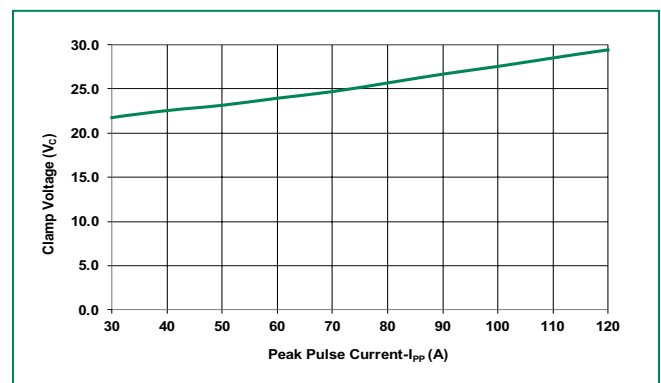

Non-Repetitive Peak Pulse Power vs. Pulse Duration (Pin1 to GND)

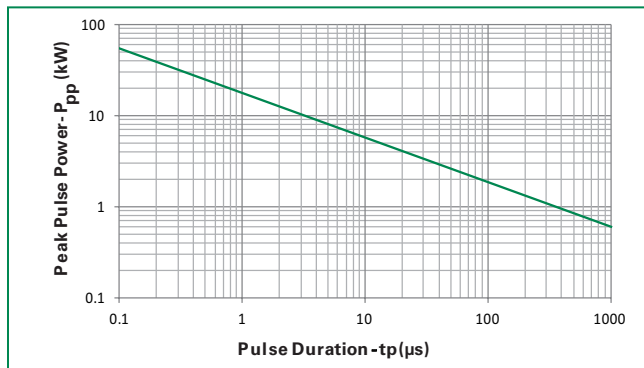

Soldering Parameters

Reflow Condition	Pb – Free assembly	
Pre Heat	- Temperature Min ($T_{s(min)}$)	150°C
	- Temperature Max ($T_{s(max)}$)	200°C
	- Time (min to max) (t_s)	60 – 180 secs
Average ramp up rate (Liquidus) Temp (T_L) to peak	3°C/second max	
$T_{s(max)}$ to T_L - Ramp-up Rate	3°C/second max	
Reflow	- Temperature (T_L) (Liquidus)	217°C
	- Temperature (t_L)	60 – 150 seconds
Peak Temperature (T_p)	260 ^{+0/-5} °C	
Time within 5°C of actual peak Temperature (t_p)	20 – 40 seconds	
Ramp-down Rate	6°C/second max	
Time 25°C to peak Temperature (T_p)	8 minutes Max.	
Do not exceed	260°C	

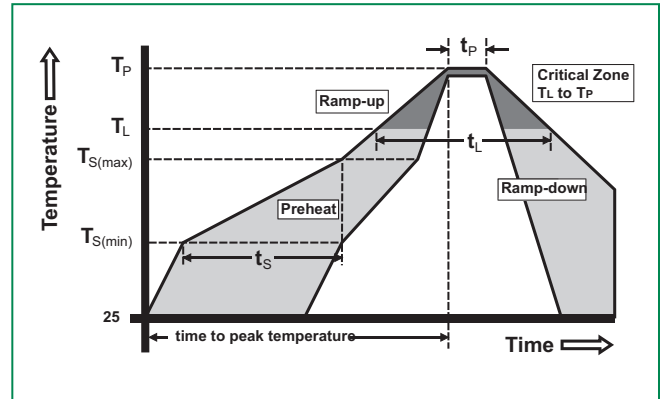

Part Numbering System

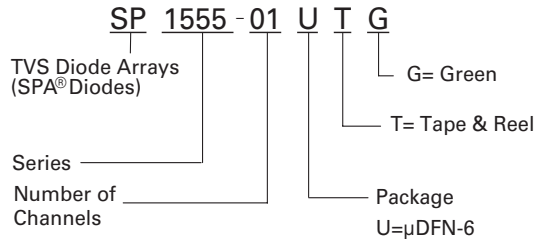

Part Marking System

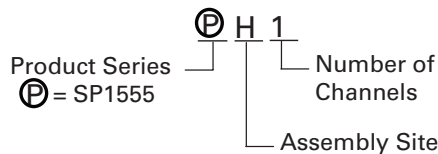

Product Characteristics

Lead Plating	Pre-Plated Frame
Lead Material	Copper Alloy
Lead Coplanarity	0.004 inches(0.102mm)
Substrate material	Silicon
Body Material	Molded Epoxy
Flammability	UL 94 V-0

Notes :

1. All dimensions are in millimeters
2. Dimensions include solder plating.
3. Dimensions are exclusive of mold flash & metal burr.
4. Blo is facing up for mold and facing down for trim/form, i.e. reverse trim/form.
5. Package surface matte finish VDI 11-13.

Ordering Information

Part Number	Package	Min. Order Qty.	Packaging Option	P0/P1	Packaging Specification
SP1555-01UTG	μDFN-6	3000	Tape & Reel – 8mm tape/7" reel	4mm/4mm	EIA RS-481

Package Dimensions — μ DFN-6 (1.8x2.0x0.55mm)

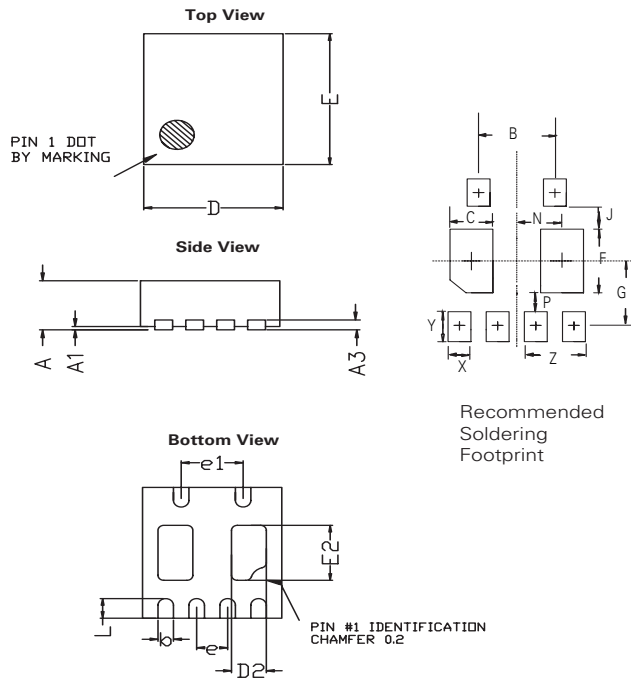

JEDEC MO-229						
Symbol	Millimeters			Inches		
	Min	Nom	Max	Min	Nom	Max
A	0.50	0.55	0.60	0.020	0.022	0.024
A1	0.00	-	0.05	0.000	-	0.002
A3	0.15 Ref			0.006 Ref		
D	1.75	1.80	1.85	0.069	0.071	0.073
E	1.95	2.00	2.05	0.077	0.079	0.081
b	0.15	0.20	0.25	0.006	0.008	0.010
L	0.20	0.30	0.40	0.008	0.012	0.016
D2	0.35	0.45	0.55	0.014	0.018	0.022
E2	0.74	0.84	0.94	0.029	0.033	0.037
e	0.40 BSC			0.016 BSC		
e1	0.80 BSC			0.031 BSC		
B	0.80 BSC			0.031 BSC		
C	0.35	0.45	0.55	0.014	0.018	0.022
F	0.81	0.84	0.87	0.032	0.033	0.034
G	0.82	0.85	0.88	0.032	0.033	0.034
J	0.24	0.25	0.26	0.010	0.010	0.010
N	0.47	0.48	0.49	0.018	0.019	0.020
P	0.24	0.25	0.26	0.010	0.010	0.010
X	0.23	0.24	0.25	0.009	0.009	0.009
Y	0.35	0.36	0.37	0.014	0.014	0.014
Z	0.62	0.64	0.66	0.024	0.025	0.026

Notes:

1. Dimension and tolerancing conform to ASME Y14.5M-1994.
2. Controlling dimensions: Millimeter. Converted Inch dimensions are not necessarily exact.

Embossed Carrier Tape & Reel Specification — μ DFN-6

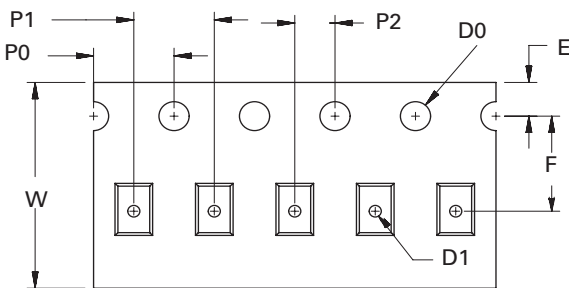

Symbol	Millimeters
A0	1.95 +/- 0.05
B0	2.30 +/- 0.05
D0	1.50 +/- 0.10
D1	Ø 0.60 + 0.05
E	1.75 +/- 0.10
F	3.50 +/- 0.05
K0	0.75 +/- 0.05
P0	4.00 +/- 0.10
P1	4.00 +/- 0.10
P2	2.00 +/- 0.05
T	0.25 +/- 0.02
W	8.00 + 0.30 / - 0.10

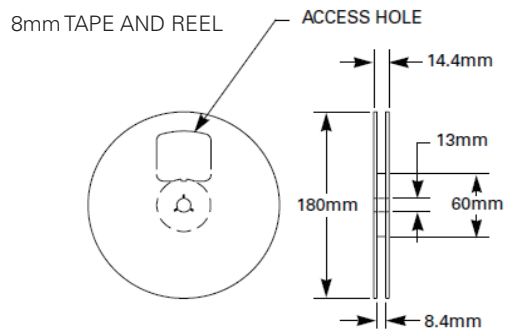
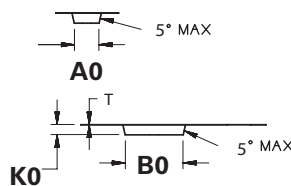
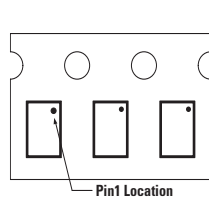

单击下面可查看定价，库存，交付和生命周期等信息

[>>Littelfuse\(美国力特\)](#)