

**T2322B**

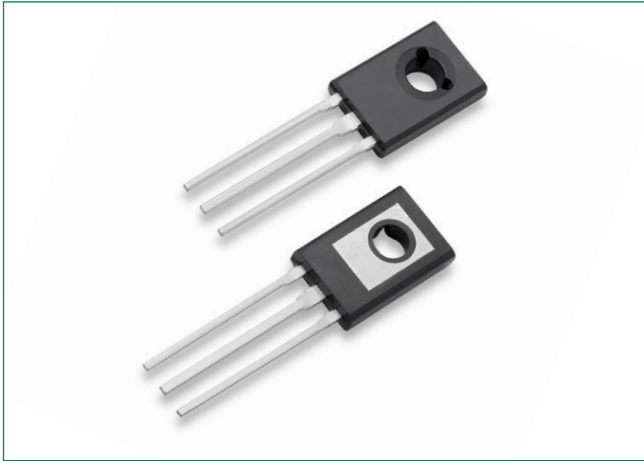

**Description**

Designed primarily for ac power switching. The gate sensitivity of these triacs permits the use of economical transistorized or integrated circuit control circuits, and it enhances their use in low-power phase control and load-switching applications.

**Features**

- Very High Gate Sensitivity
- Low On-State Voltage at High Current Levels
- Glass-Passivated Chip for Stability
- Small, Rugged Thermopad Construction for Low Thermal Resistance, High Heat Dissipation and Durability
- Pb-Free Package is Available

**Pin Out**

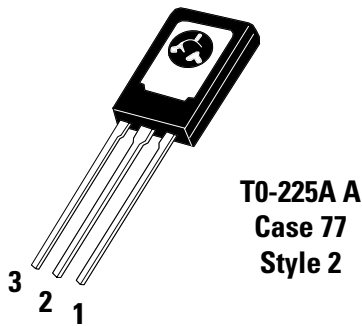

**Functional Diagram**

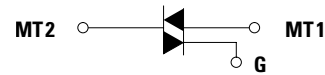

### Maximum Ratings ( $T_J = 25^\circ\text{C}$ unless otherwise noted)

Rating	Symbol	Value	Unit
Peak Repetitive Off-State Voltage (Note 1) ( $T_J = 25$ to $110^\circ\text{C}$ , Gate Open)	$V_{\text{DRM}}'$ $V_{\text{RRM}}$	200	V
On-State RMS Current ( $T_C = 70^\circ\text{C}$ )(Full Cycle Sine Wave 50 to 60 Hz)	$I_{\text{T (RMS)}}$	2.5	A
Peak Non-Repetitive Surge Current (One Full Cycle, Sine Wave 60 Hz, $T_C = 70^\circ\text{C}$ )	$I_{\text{TSM}}$	25	A
Circuit Fusing Considerations ( $t = 8.3$ ms)	$I^2t$	2.6	A <sup>2</sup> s
Peak Gate Power (Pulse Width $\leq 10$ sec, $T_C = 70^\circ\text{C}$ )	$P_{\text{GM}}$	10	W
Average Gate Power ( $t = 8.3$ msec, $T_A = 25^\circ\text{C}$ )	$P_{\text{GM (AV)}}$	0.5	W
Peak Gate Current (Pulse Width = $10 \mu\text{s}$ , $T_C = 70^\circ\text{C}$ )	$I_{\text{GM}}$	0.5	A
Operating Junction Temperature Range @ Rated $V_{\text{RRM}}$ and $V_{\text{DRM}}$	$T_J$	-40 to +110	$^\circ\text{C}$
Storage Temperature Range	$T_{\text{stg}}$	-40 to +150	$^\circ\text{C}$
Mounting Torque (6-32 Screw) (Note 2)	–	8.0	in. lb.

Stresses exceeding Maximum Ratings may damage the device. Maximum Ratings are stress ratings only. Functional operation above the Recommended Operating Conditions is not implied. Extended exposure to stresses above the Recommended Operating Conditions may affect device reliability.

- $V_{\text{DRM}}$  and  $V_{\text{RRM}}$  for all types can be applied on a continuous basis. Ratings apply for zero or negative gate voltage; however, positive gate voltage shall not be applied concurrent with negative potential on the anode. Blocking voltages shall not be tested with a constant current source such that the voltage ratings of the devices are exceeded.
- Torque rating applies with use of torque washer (Shakeproof WD19523 or equivalent). Mounting Torque in excess of 6 in. lb. does not appreciably lower case-to-sink thermal resistance. Main terminal 2 and heat-sink contact pad are common.

### Thermal Characteristics

Rating	Symbol	Value	Unit
Thermal Resistance, Junction-to-Ambient PCB Mounted	$R_{\theta\text{JA}}$	3.5	$^\circ\text{C/W}$
Thermal Resistance, Junction-to-Tab Measured on MT2 Tab Adjacent to Epoxy	$R_{\theta\text{JT}}$	60	$^\circ\text{C/W}$
Maximum Device Temperature for Soldering Purposes for 10 Secs Maximum	$T_L$	260	$^\circ\text{C}$

### Electrical Characteristics - OFF ( $T_J = 25^\circ\text{C}$ unless otherwise noted)

Characteristic	Symbol	Min	Typ	Max	Unit	
Peak Repetitive Forward or Reverse Blocking Current ( $V_D = \text{Rated } V_{\text{DRM}}'$ and $V_{\text{RRM}}'$ ; Gate Open)	$I_{\text{DRM}}'$ $I_{\text{RRM}}$	$T_J = 25^\circ\text{C}$	-	-	1.0	mA
		$T_J = 110^\circ\text{C}$	-	0.2	0.75	

### Electrical Characteristics - ON ( $T_J = 25^\circ\text{C}$ unless otherwise noted; Electricals apply in both directions)

Characteristic	Symbol	Min	Typ	Max	Unit
Peak Forward On-State Voltage (Note 3) ( $I_{\text{TM}} = \pm 10$ A)	$V_{\text{TM}}$	–	1.7	2.2	V
Gate Trigger Current (Continuous dc) ( $V_D = 12$ V, $R_L = 100 \Omega$ , All Quadrants)	$I_{\text{GT}}$	–	–	10	mA
Gate Trigger Voltage (Continuous dc) ( $V_D = 12$ Vdc, $R_L = 100 \Omega$ , $T_C = 25^\circ\text{C}$ )	$V_{\text{GT}}$	–	1.0	2.2	V
Gate Non-Trigger Voltage ( $V_D = 12$ Vdc, $R_L = 100 \Omega$ , $T_C = 110^\circ\text{C}$ )	$V_{\text{GD}}$	0.15	–	–	V
Holding Current ( $V_D = 12$ V, $I_{\text{T}}$ (Initiating Current) = $\pm 200$ mA, Gate Open)	$I_{\text{H}}$	–	15	30	mA
Gate Controlled Turn-On Time ( $V_D = \text{Rated } V_{\text{DRM}}'$ , $I_{\text{TM}} = 10$ A pk, $I_{\text{G}} = 60$ mA, $t_r = 0.1$ sec)	$t_{\text{gt}}$	–	1.8	2.5	$\mu\text{s}$

### Dynamic Characteristics

Characteristic	Symbol	Min	Typ	Max	Unit
Critical Rate-of-Rise of Off State Voltage ( $V_D = \text{Rated } V_{DRM}$ , Exponential Waveform, $T_C = 100^\circ\text{C}$ )	dv/dt	10	100	–	V/ $\mu\text{s}$
Critical Rate of Rise of On–State Current ( $V_D = \text{Rated } V_{DRM}$ , $I_{TM} = 3.5 \text{ A pk}$ , Commutating di/dt = 1.26 A/ms, Gate Unenergized, $T_C = 90^\circ\text{C}$ )	di/dt	1.0	4.0	–	A/ $\mu\text{s}$

2. Pulse Width = 1.0 ms, Duty Cycle  $\leq$  1%.

### Voltage Current Characteristic of SCR

Symbol	Parameter
$V_{DRM}$	Peak Repetitive Forward Off State Voltage
$I_{DRM}$	Peak Forward Blocking Current
$V_{RRM}$	Peak Repetitive Reverse Off State Voltage
$I_{RRM}$	Peak Reverse Blocking Current
$V_{TM}$	Maximum On State Voltage
$I_H$	Holding Current

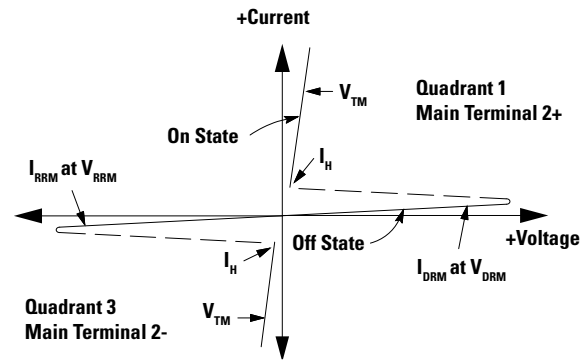

### Quadrant Definitions for a Triac

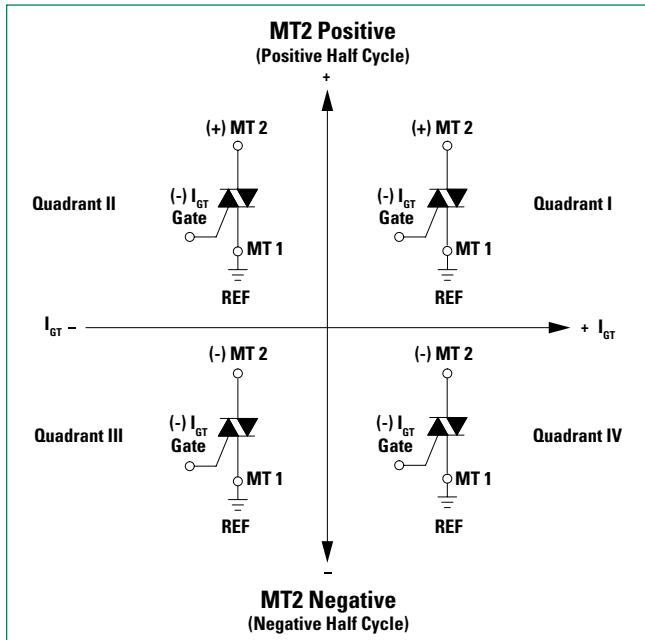

All Polarities are referenced to MT1.  
With in-phase signals (using standard AC lines) quadrants I and III are used

### Dimensions

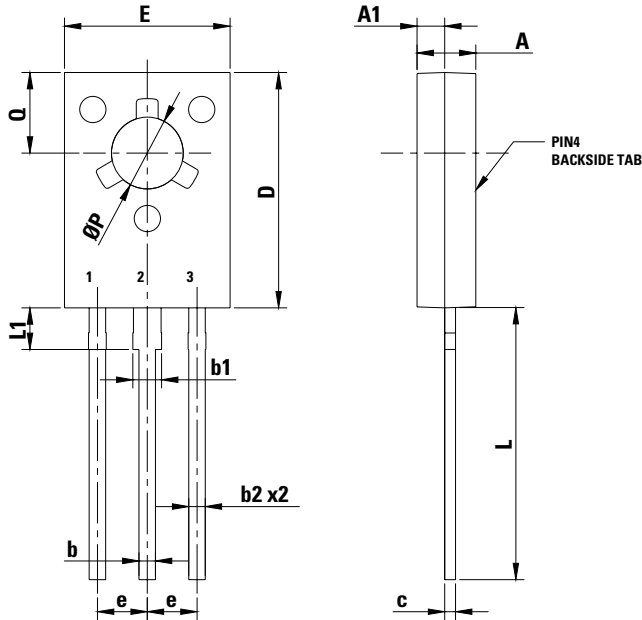

Dim	Inches		Millimeters	
	Min	Max	Min	Max
A	0.102	0.110	2.60	2.80
A1	0.047	0.055	1.20	1.40
b	0.028	0.034	0.70	0.86
b2	0.028	0.034	0.70	0.86
c	0.019	0.022	0.49	0.57
D	0.417	0.449	10.60	11.40
E	0.291	0.323	7.40	8.20
e	0.090 TYP		2.29 TYP	
L	0.551	0.630	14.00	16.00
L1	0.091	0.106	2.30	2.70
P	0.118	0.134	3.00	3.40
Q	0.142	0.157	3.60	4.00
b1	0.047	0.055	1.2	1.4

1. Dimensioning and Tolerancing Per ANSI Y14.5M, 1982.
2. Controlling Dimension: Inch.
3. 077-01 Thru -08 Obsolete, New Standard 077-09.

### Part Marking System

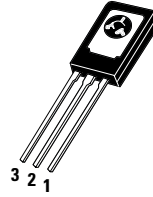

T0-225AA  
Case 077  
Style 2

1. Cathode
2. Anode
3. Gate

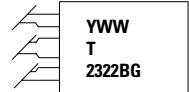

Y = Year  
WW = Wor Week  
T2322BA = Device Code  
G = Pb-Free Package

### Pin Assignment

Pin	Assignment
1	Cathode
2	Anode
3	Gate
4	Anode

### Ordering Information

Device	Package	Shipping
T2322B	TO225AA	500 Units/Box
T2322BG	TO225AA (Pb-Free)	

单击下面可查看定价，库存，交付和生命周期等信息

[>>Littelfuse\(美国力特\)](#)