

L50QS SERIES HIGH-SPEED ROUND BODY FUSES

500 Vac/dc • 35-800 A • Traditional Round Body Bolted Style



Description

The L50QS Series is a next generation High-Speed Fuse for the protection of power semiconductor devices and is designed in the Traditional North American Bolted Style package.

L50QS Series High-Speed Fuses are extremely current limiting and are used to protect power converters, drives and control circuit applications. Designed with lower I²t performance characteristics, these fuses provide balanced performance to extend longevity while lowering potentially damaging heat energy to the devices being protected.

In addition L50QS Series fuses have been designed with a universal mounting option to meet customer requirements for installation into a variety of application configurations

Littelfuse POWR-SPEED™ products offer optimized circuit protection at the extremely fast speed required to protect modern day, sensitive, high-power semiconductor devices. Such products are commonly found in various industries including pulp and paper industries, cranes and heavy-lifting equipment, processing industries, wastewater treatment plants and large factories and MRO facilities.

Features

- Compliance with US and Canadian Requirements
- Traditional North American Bolted Style dimensions
- Class aR performance
- Direct bus-bar mount or stud mount design
- Halogen Free, RoHS and REACH Compliant

Applications

- Power Converters (Inverters, Rectifiers)
- Power Supplies
- UPS
- Variable Speed Drives
- Control Circuits
- Soft Starters

Specifications

| | |
|------------------------------|--|
| Voltage Rating | AC: 500V DC: 500V |
| Amperage Rating | 35 - 800 A |
| Interrupting Rating | AC: 200 kA DC: 50 kA |
| Time Constant | 10ms |
| Material | Body: Melamine Caps: Copper Alloy (Silver Plated) |
| Approvals | UL Recognized (E71611) c-UR-us (E71611) |
| Environmental | RoHS Compliant, REACH |
| Country of Origin | Mexico |
| Operating Temperature | -55C to +125C |
| Storage Temperature | Up to 35C with Relative Humidity <65% |

Part Numbering System

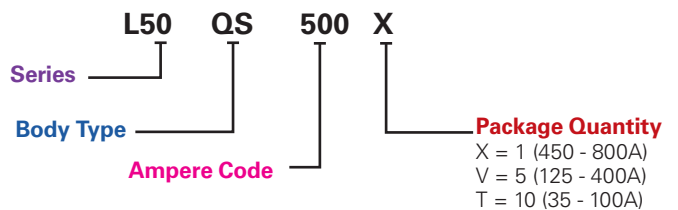

| SERIES | BODY TYPE | AMPERE CODE | PACKAGE QUANTITY | CATALOG NUMBER | ORDERING NUMBER |
|--------|-----------|-------------|------------------|----------------|-----------------|
| L50 | QS | 500 | 1 | L50QS500 | L50QS500.X |

Recommended Fuse Blocks

LSCR001 (35-200A)
LSCR002 (225-800A)



Web Resources

Download technical documents: littelfuse.com/L50QS

L50QS SERIES HIGH-SPEED ROUND BODY FUSES

Electrical Specifications

| CATALOG NUMBER | AMPERAGE RATING | VOLTAGE RATING | | INTERRUPT RATING | | MELTING (PRE-ARC) I ² T (A ² s) | TOTAL CLEARING I ² T (A ² s) | TOTAL CLEARING I ² T (A ² s) | WATTS LOSS AT 80% RATED CURRENT | WATTS LOSS AT 100% RATED CURRENT |
|----------------|-----------------|----------------|-----|------------------|------|---|--|--|---------------------------------|----------------------------------|
| | | AC | DC | AC | DC | | 200 kA @ 500 Vac | 50 kA @ 500 Vdc | (W) | (W) |
| | | | | | | | | | | |
| L50QS035 | 35 | 500 | 500 | 200kA | 50kA | 111 | 430 | 290 | 3 | 5 |
| L50QS040 | 40 | 500 | 500 | 200kA | 50kA | 137 | 530 | 363 | 3 | 9 |
| L50QS050 | 50 | 500 | 500 | 200kA | 50kA | 211 | 770 | 516 | 5 | 8 |
| L50QS060 | 60 | 500 | 500 | 200kA | 50kA | 269 | 1,500 | 881 | 5 | 9 |
| L50QS070 | 70 | 500 | 500 | 200kA | 50kA | 393 | 1,775 | 1,185 | 6 | 11 |
| L50QS080 | 80 | 500 | 500 | 200kA | 50kA | 616 | 3,550 | 1,720 | 6 | 11 |
| L50QS090 | 90 | 500 | 500 | 200kA | 50kA | 720 | 4,075 | 1,990 | 8 | 14 |
| L50QS100 | 100 | 500 | 500 | 200kA | 50kA | 905 | 4,577 | 2,313 | 9 | 17 |
| L50QS125 | 125 | 500 | 500 | 200kA | 50kA | 1,503 | 7,655 | 4,815 | 10 | 17 |
| L50QS150 | 150 | 500 | 500 | 200kA | 50kA | 2,382 | 11,100 | 7,190 | 12 | 21 |
| L50QS175 | 175 | 500 | 500 | 200kA | 50kA | 3,148 | 16,500 | 9,900 | 14 | 25 |
| L50QS200 | 200 | 500 | 500 | 200kA | 50kA | 4,102 | 18,233 | 11,567 | 17 | 32 |
| L50QS225 | 225 | 500 | 500 | 200kA | 50kA | 5,379 | 25,300 | 16,700 | 19 | 35 |
| L50QS250 | 250 | 500 | 500 | 200kA | 50kA | 7,094 | 31,350 | 22,500 | 20 | 37 |
| L50QS275 | 275 | 500 | 500 | 200kA | 50kA | 9,655 | 40,175 | 30,177 | 21 | 39 |
| L50QS300 | 300 | 500 | 500 | 200kA | 50kA | 11,240 | 53,800 | 36,150 | 25 | 46 |
| L50QS325 | 325 | 500 | 500 | 200kA | 50kA | 13,183 | 56,250 | 41,000 | 27 | 51 |
| L50QS350 | 350 | 500 | 500 | 200kA | 50kA | 14,246 | 68,850 | 44,800 | 30 | 61 |
| L50QS400 | 400 | 500 | 500 | 200kA | 50kA | 21,155 | 100,300 | 67,300 | 33 | 65 |
| L50QS450 | 450 | 500 | 500 | 200kA | 50kA | 26,425 | 121,000 | 84,650 | 35 | 63 |
| L50QS500 | 500 | 500 | 500 | 200kA | 50kA | 31,747 | 141,000 | 103,500 | 39 | 72 |
| L50QS600 | 600 | 500 | 500 | 200kA | 50kA | 43,922 | 193,500 | 128,000 | 49 | 92 |
| L50QS700 | 700 | 500 | 500 | 200kA | 50kA | 75,597 | 314,000 | 230,000 | 51 | 92 |
| L50QS800 | 800 | 500 | 500 | 200kA | 50kA | 92,717 | 393,500 | 280,000 | 63 | 117 |

L50QS SERIES HIGH-SPEED ROUND BODY FUSES

Ordering Information

| SERIES | AMPERAGE RATING | AMPERE CODE | CATALOG NUMBER | ORDERING NUMBER | PACK QUANTITY | UPC |
|--------|-----------------|-------------|----------------|-----------------|---------------|-------------|
| L50QS | 35 | 035 | L50QS035 | L50QS035.T | 10 Pcs/ Box | 07945885991 |
| L50QS | 40 | 040 | L50QS040 | L50QS040.T | 10 Pcs/ Box | 07945885992 |
| L50QS | 50 | 050 | L50QS050 | L50QS050.T | 10 Pcs/ Box | 07945885993 |
| L50QS | 60 | 060 | L50QS060 | L50QS060.T | 10 Pcs/ Box | 07945885994 |
| L50QS | 70 | 070 | L50QS070 | L50QS070.T | 10 Pcs/ Box | 07945885995 |
| L50QS | 80 | 080 | L50QS080 | L50QS080.T | 10 Pcs/ Box | 07945885996 |
| L50QS | 90 | 090 | L50QS090 | L50QS090.T | 10 Pcs/ Box | 07945885997 |
| L50QS | 100 | 100 | L50QS100 | L50QS100.T | 10 Pcs/ Box | 07945885998 |
| L50QS | 125 | 125 | L50QS125 | L50QS125.V | 5 Pcs/ Box | 07945885999 |
| L50QS | 150 | 150 | L50QS150 | L50QS150.V | 5 Pcs/ Box | 07945886000 |
| L50QS | 175 | 175 | L50QS175 | L50QS175.V | 5 Pcs/ Box | 07945886001 |
| L50QS | 200 | 200 | L50QS200 | L50QS200.V | 5 Pcs/ Box | 07945886002 |
| L50QS | 225 | 225 | L50QS225 | L50QS225.V | 5 Pcs/ Box | 07945886003 |
| L50QS | 250 | 250 | L50QS250 | L50QS250.V | 5 Pcs/ Box | 07945886004 |
| L50QS | 275 | 275 | L50QS275 | L50QS275.V | 5 Pcs/ Box | 07945886005 |
| L50QS | 300 | 300 | L50QS300 | L50QS300.V | 5 Pcs/ Box | 07945886006 |
| L50QS | 325 | 325 | L50QS325 | L50QS325.V | 5 Pcs/ Box | 07945886011 |
| L50QS | 350 | 350 | L50QS350 | L50QS350.V | 5 Pcs/ Box | 07945886007 |
| L50QS | 400 | 400 | L50QS400 | L50QS400.V | 5 Pcs/ Box | 07945886008 |
| L50QS | 450 | 450 | L50QS450 | L50QS450.X | 1 Pc/ Box | 07945886009 |
| L50QS | 500 | 500 | L50QS500 | L50QS500.X | 1 Pc/ Box | 07945886010 |
| L50QS | 600 | 600 | L50QS600 | L50QS600.X | 1 Pc/ Box | 07945886012 |
| L50QS | 700 | 700 | L50QS700 | L50QS700.X | 1 Pc/ Box | 07945886013 |
| L50QS | 800 | 800 | L50QS800 | L50QS800.X | 1 Pc/ Box | 07945886014 |

L50QS SERIES HIGH-SPEED ROUND BODY FUSES

Dimensions

Millimeters [inches]

Document Number: OL-L50QS000

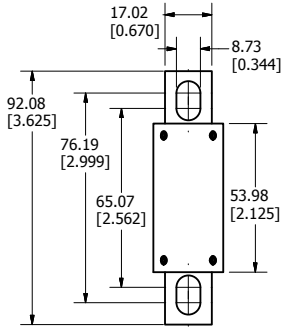

35-100A

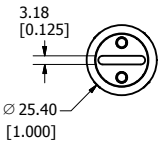

Stud Size: M8 (5/16")

Recommended Torque: 15 Nm (132.76 in-lb)

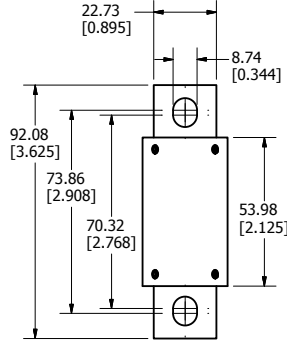

125-200A

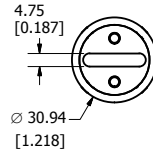

Stud Size: M8 (5/16")

Recommended Torque: 15 Nm (132.76 in-lb)

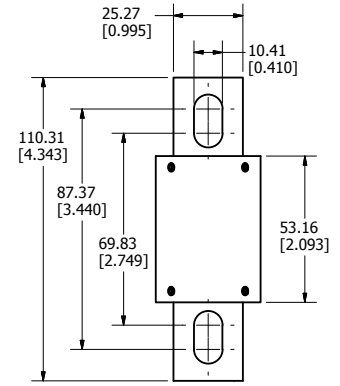

225-400A

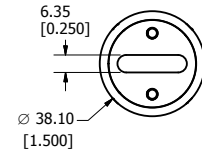

Stud Size: M8 (5/16")

Recommended Torque: 15 Nm (132.76 in-lb)

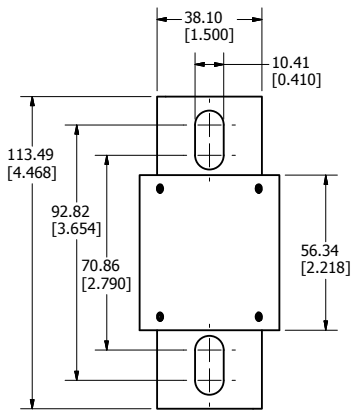

450-600A

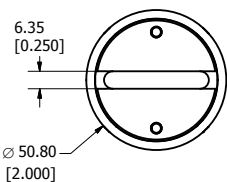

Stud Size: M8 (5/16")

Recommended Torque: 15 Nm (132.76 in-lb)

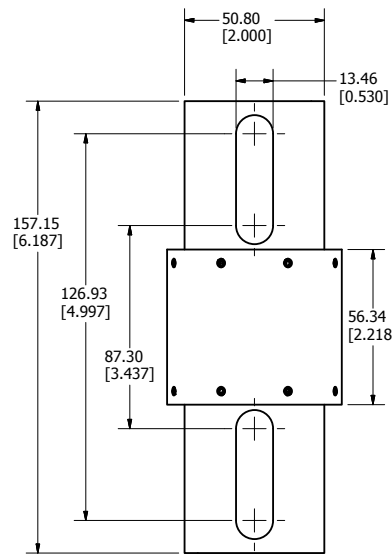

700-800A

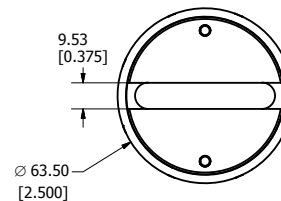

Stud Size: M12 (1/2")

Recommended Torque: 54 Nm (477.94 in-lb)

L50QS SERIES HIGH-SPEED ROUND BODY FUSES

Time Current Curve L50QS Series

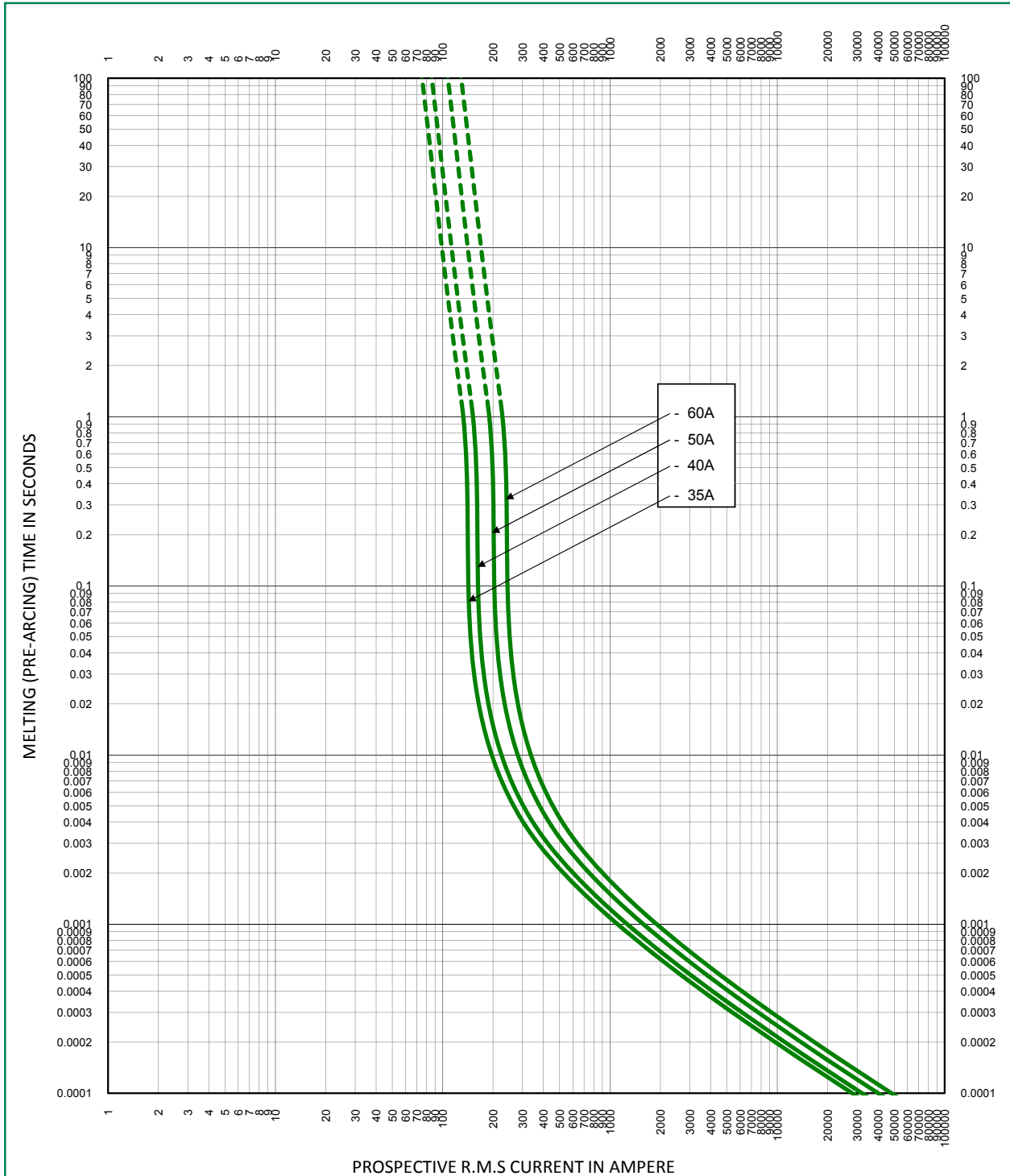

L50QS SERIES HIGH-SPEED ROUND BODY FUSES

Time Current Curve L50QS Series

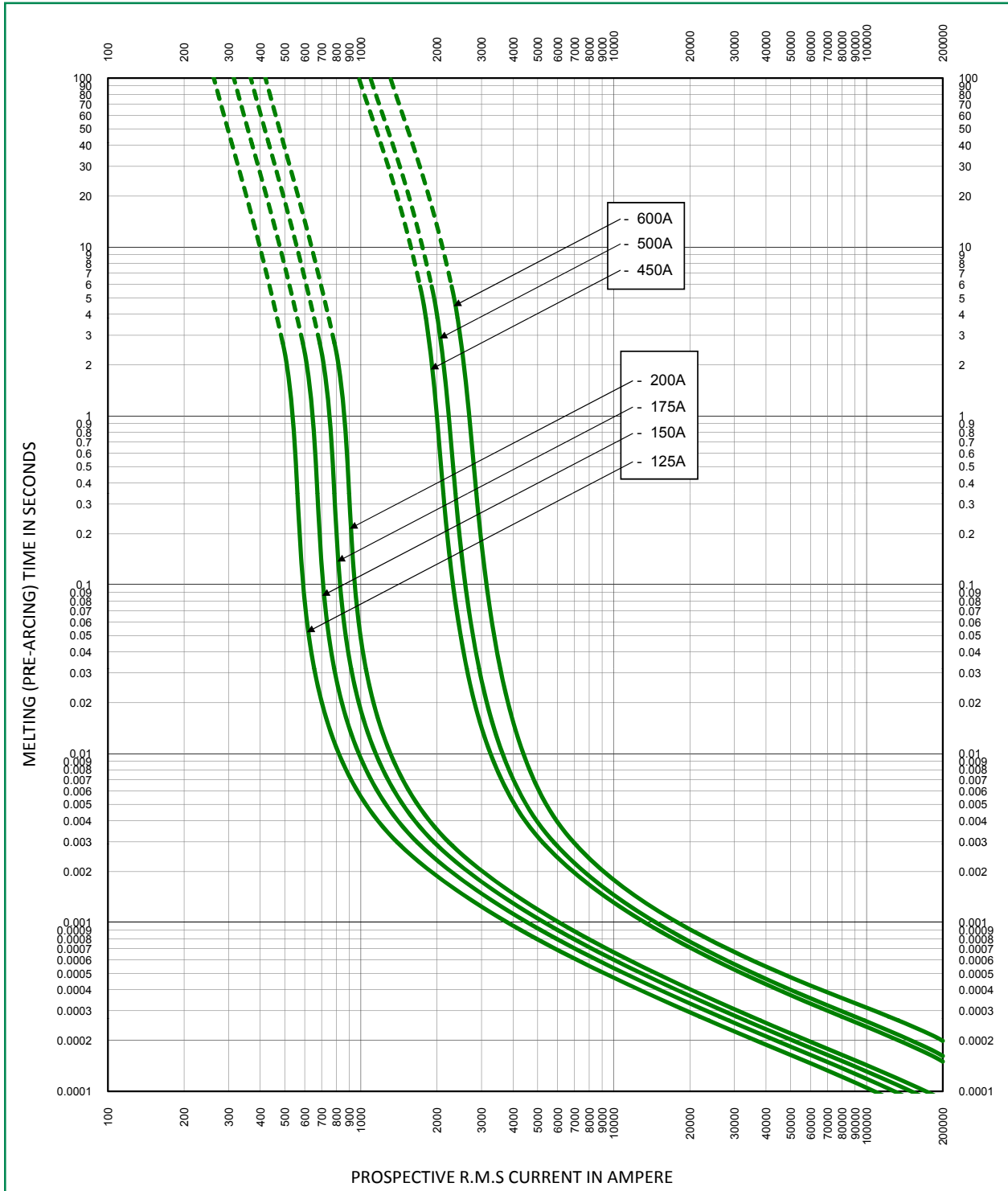

L50QS SERIES HIGH-SPEED ROUND BODY FUSES

Time Current Curve L50QS Series

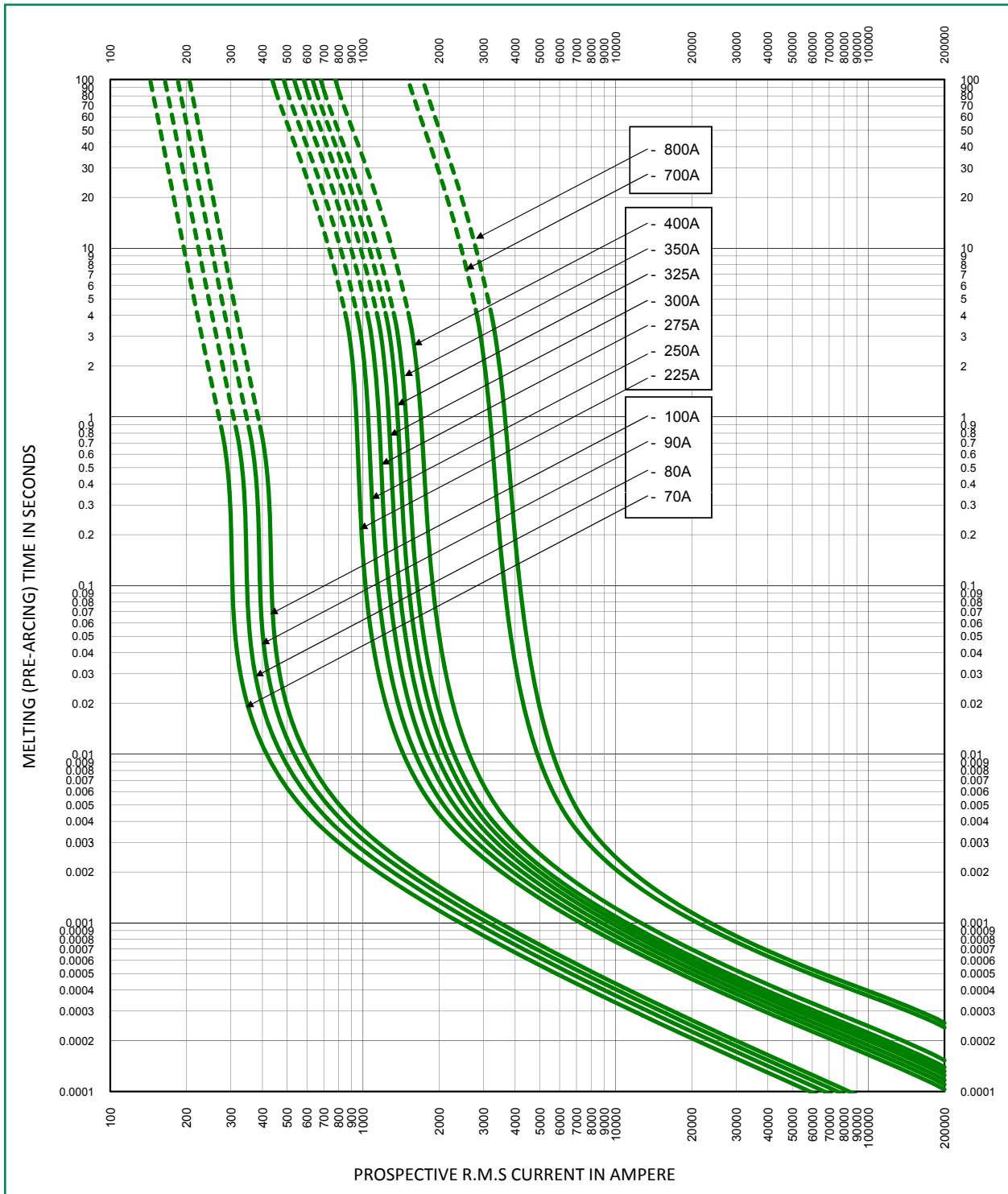

L50QS SERIES HIGH-SPEED ROUND BODY FUSES

Peak Let-Thru Curve L50QS Series

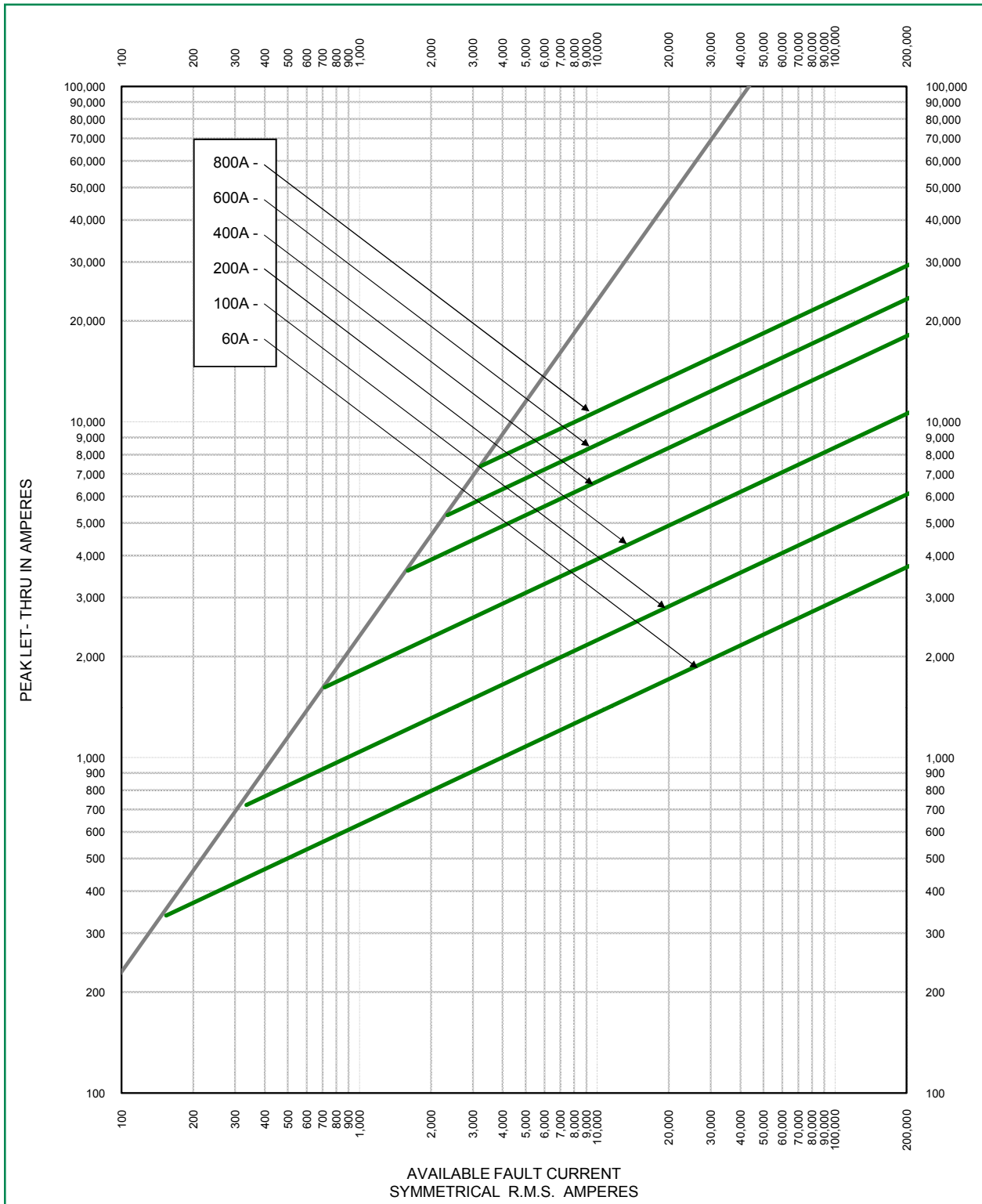

L50QS SERIES HIGH-SPEED ROUND BODY FUSES

Temperature De-rating Curve (Temperature of Air Immediately Surrounding Fuse)
L50QS Series

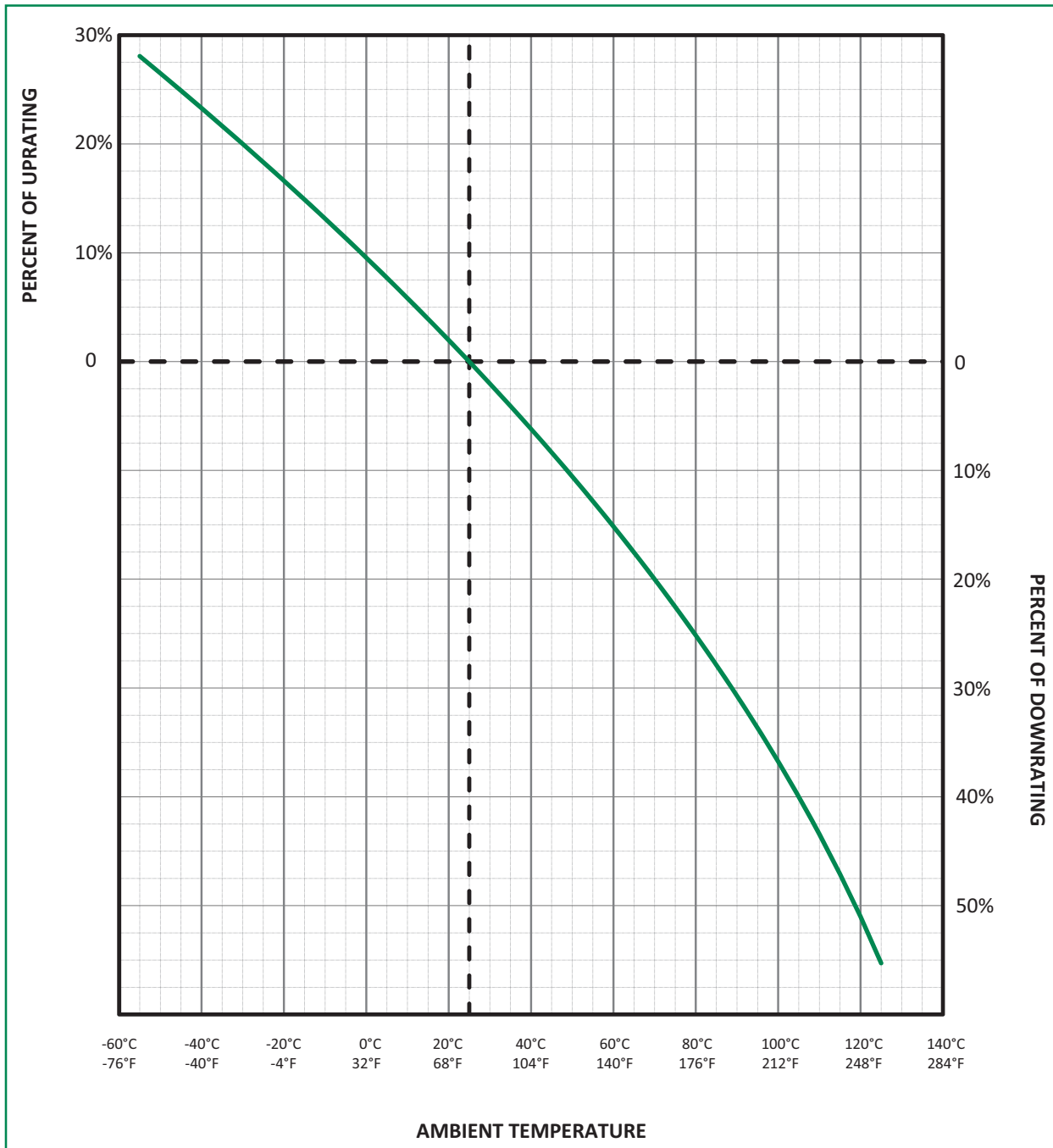

L50QS SERIES HIGH-SPEED ROUND BODY FUSES

Total Clearing I²t Correction Factor Curve

L50QS Series

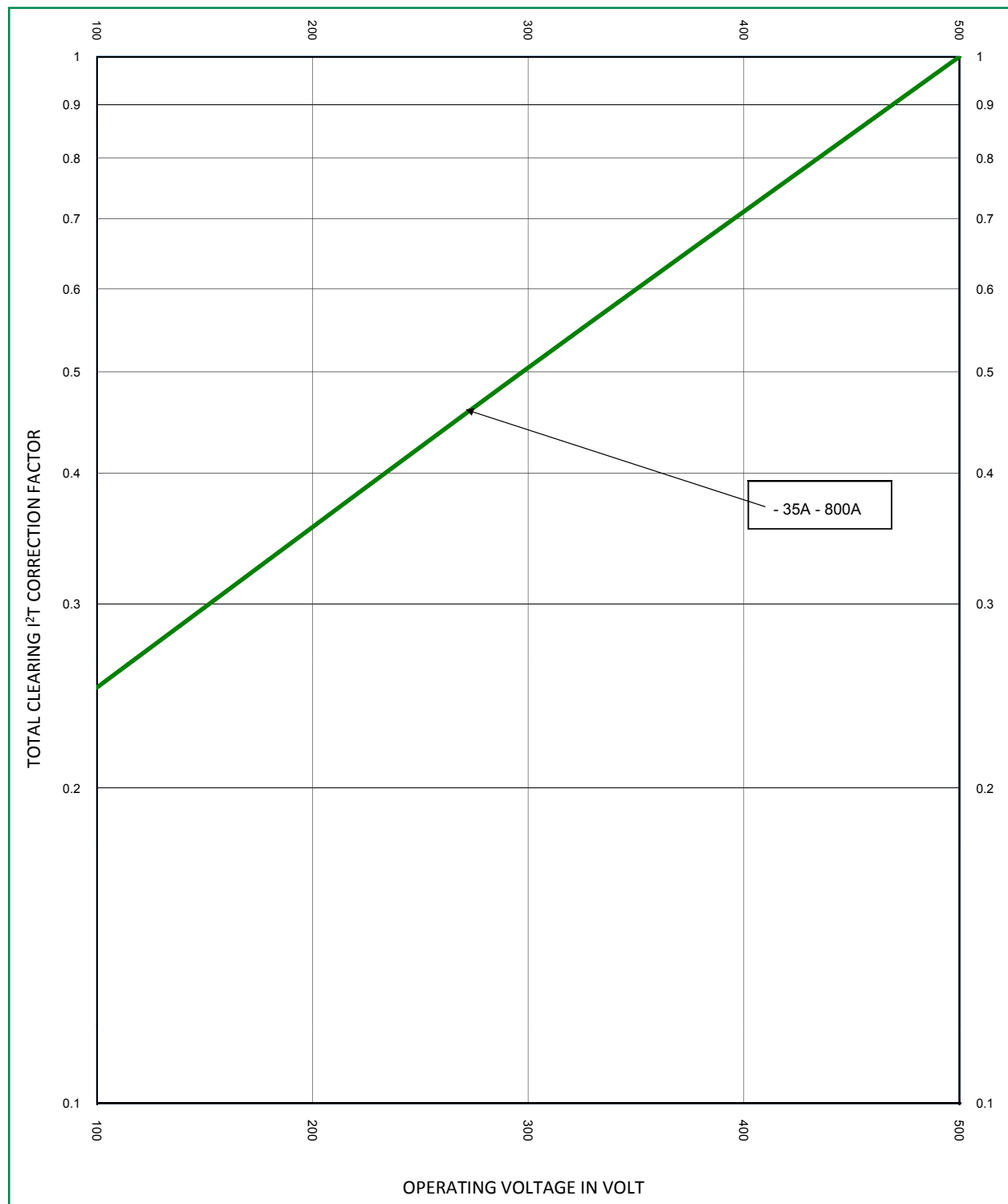

L50QS SERIES HIGH-SPEED ROUND BODY FUSES

Watts Loss Correction Factor Curve

L50QS Series

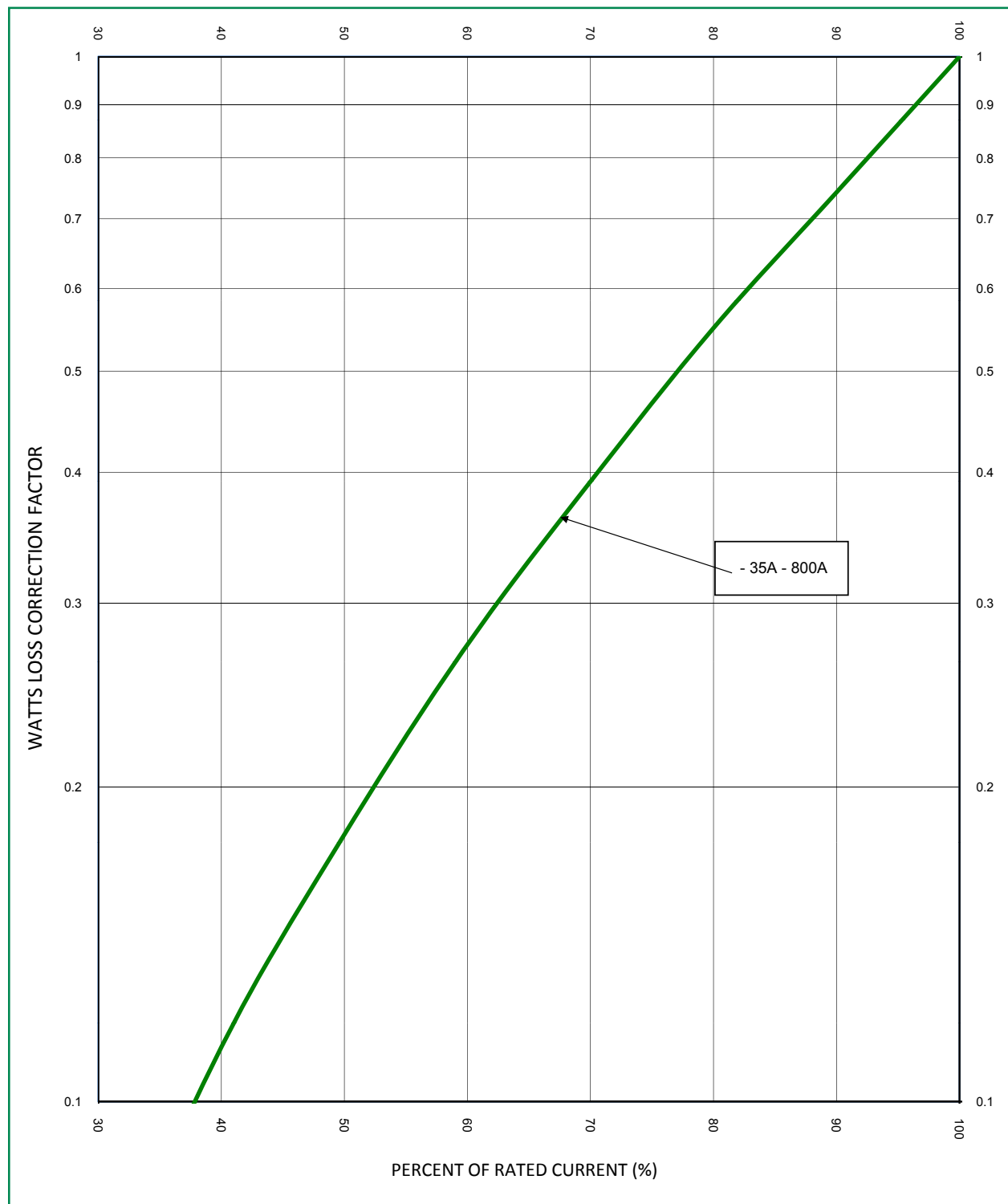

L50QS SERIES HIGH-SPEED ROUND BODY FUSES

Peak Arc Voltage Curve L50QS Series

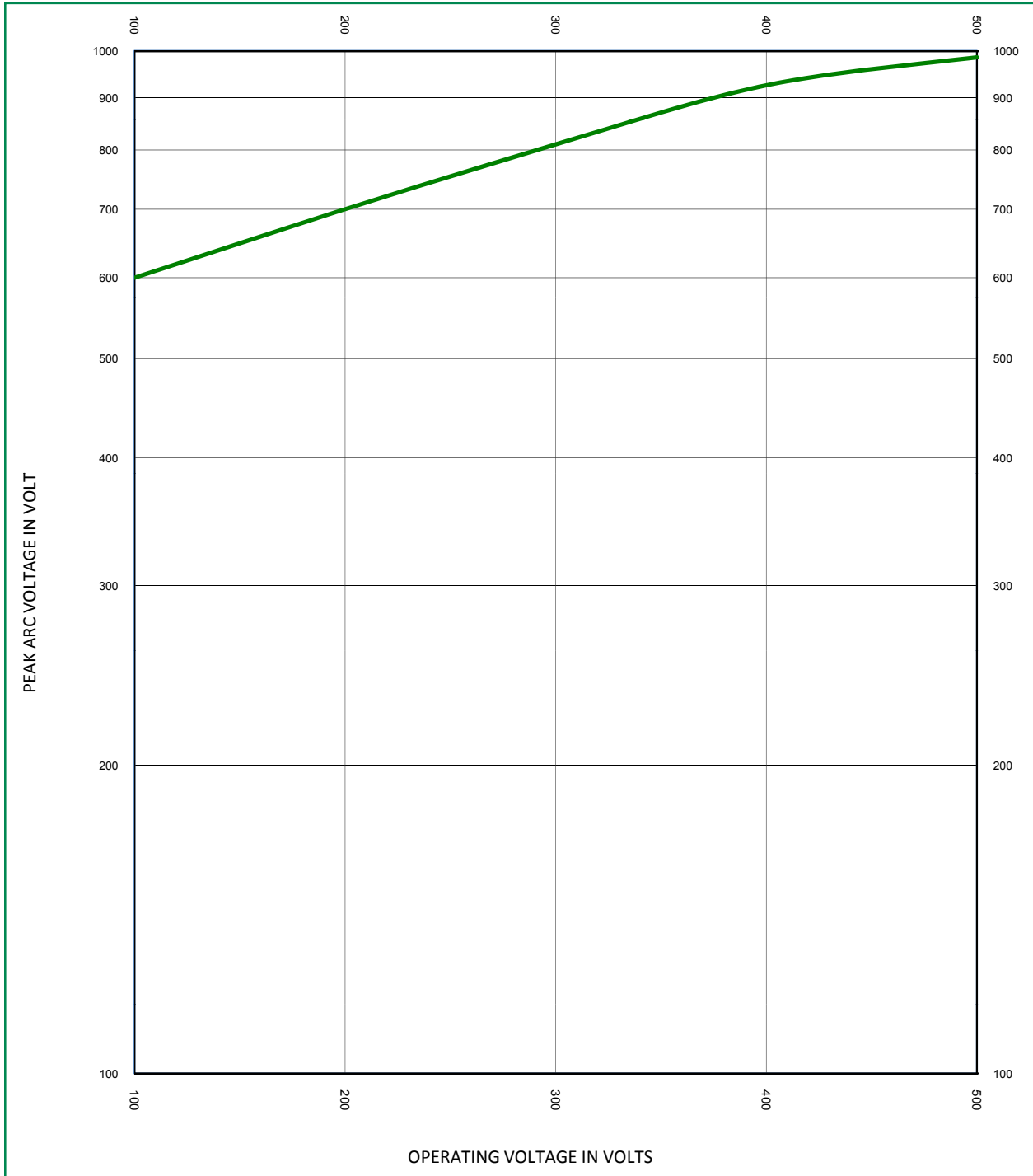

Disclaimer Notice - Littelfuse products are not designed for, and shall not be used for, any purpose (including, without limitation, automotive, military, aerospace, medical, life-saving, life-sustaining or nuclear facility applications, devices intended for surgical implant into the body, or any other application in which the failure or lack of desired operation of the product may result in personal injury, death, or property damage) other than those expressly set forth in applicable Littelfuse product documentation. Warranties granted by Littelfuse shall be deemed void for products used for any purpose not expressly set forth in applicable Littelfuse documentation. Littelfuse shall not be liable for any claims or damages arising out of products used in applications not expressly intended by Littelfuse as set forth in applicable Littelfuse documentation. The sale and use of Littelfuse products is subject to Littelfuse Terms and Conditions of Sale, unless otherwise agreed by Littelfuse.

Littelfuse.com/Product-Disclaimer

单击下面可查看定价，库存，交付和生命周期等信息

[>>Littelfuse\(美国力特\)](#)