

## SP0502B Series 1pF 15kV Diode Arrays



### Description

The SP0502B is a low capacitance TVS diode array designed to protect high-speed data interfaces from over-voltage caused by ESD (electrostatic discharge), CDE (Cable Discharge Events), and EFT (electrical fast transients). It has a typical capacitance of only 0.3pF (pin 1 to 2) making it suitable for use on circuits operating in excess of 3GHz without signal attenuation.

The SP0502BXTG is in a small SOT-523 package and each device can be configured to protect 1 bidirectional line or two unidirectional lines. The combination of small size, ultra-low capacitance, and high level of ESD protection makes it an ideal solution for applications such as HDMI, USB, MDDI, antennas, and DisplayPort.

### Functional Block Diagram and Pinout

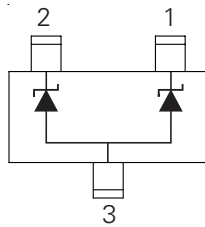

Life Support Note:

**Not Intended for Use in Life Support or Life Saving Applications**

The products shown herein are not designed for use in life sustaining or life saving applications unless otherwise expressly indicated.

### Features

- RoHS compliant and lead-free
- ESD protection of ±15kV contact discharge, ±20kV air discharge, (IEC 61000-4-2)
- EFT, IEC 61000-4-4, 40A (5/50ns)
- Lightning protection, IEC 61000-4-5 2nd edition, 2A ( $t_p=8/20\mu s$ )
- Stand-off voltage of 5V
- Low capacitance of 1pF @  $V_R=0V$  (MAX)
- Low leakage current of 0.5µA at 5V (MAX)
- Small form factor (SOT523) and low profile (<1mm)
- No insertion loss to >3.0GHz

### Additional Information



Datasheet



Resources



Samples

### Applications

- High-Definition Multimedia Interface (HDMI)
- Mobile Display Digital Interface (MDDI)
- RF/Antenna Circuits
- USB 2.0
- DisplayPort
- Mobile - Smartphone, Tablet, Notebook

### Absolute Maximum Ratings

Symbol	Parameter	Value	Units
$P_{PK}$	Peak Pulse Power ( $t_p=8/20\mu s$ )	25	W
$I_{PP}$	Peak Pulse Current ( $t_p=8/20\mu s$ )	2	A
$T_{OP}$	Operating Temperature	-40 to 125	°C
$T_{STOR}$	Storage Temperature	-55 to 150	°C

CAUTION: Stresses above those listed in "Absolute Maximum Ratings" may cause permanent damage to the device. This is a stress only rating and operation of the device at these or any other conditions above those indicated in the operational sections of this specification is not implied.

### Thermal Information

Parameter	Rating	Units
Storage Temperature Range	-55 to 150	°C
Maximum Junction Temperature	150	°C
Maximum Lead Temperature (Soldering 20-40s)	260	°C

### Electrical Characteristics ( $T_{OP} = 25^\circ C$ )

Parameter	Symbol	Test Conditions	Min	Typ	Max	Units
Reverse Standoff Voltage	$V_{RWM}$	$I_R \leq 1\mu A$ , Pin1 or Pin2 to Pin3 and Pin1 to Pin2			5.0	V
Reverse Breakdown Voltage	$V_{BR}$	$I_t = 1mA$ , Pin1 or Pin2 to Pin3	6			V
Leakage Current	$I_{LEAK}$	$V_R = 5V$			0.5	$\mu A$
Clamp Voltage <sup>1</sup>	$V_C$	$I_{PP} = 1A$ , $t_p = 8/20\mu s$ , Pin 1 to Pin 2			12	V
Dynamic Resistance <sup>2</sup>	$R_{DYN}$	TLP, $t_p = 100ns$ , I/O to GND		0.45		$\Omega$
ESD Withstand Voltage <sup>1</sup>	$V_{ESD}$	IEC 61000-4-2 (Contact Discharge)	$\pm 15$			kV
		IEC 61000-4-2 (Air Discharge)	$\pm 20$			kV
Diode Capacitance <sup>1</sup>	$C_{I/O-I/O}$	Reverse Bias=0V, $f=1MHz$ ; Pin 1 to Pin2		0.25	0.5	pF
	$C_{I/O-GND}$	Reverse Bias=0V, $f=1MHz$ ; Pin 1 or Pin2 to Pin 3			1.0	pF

Note:

1 Parameter is guaranteed by design and/or device characterization.

2 Transmission Line Pulse (TLP) with 100ns width and 200ps rise time.

**Pulse Waveform**

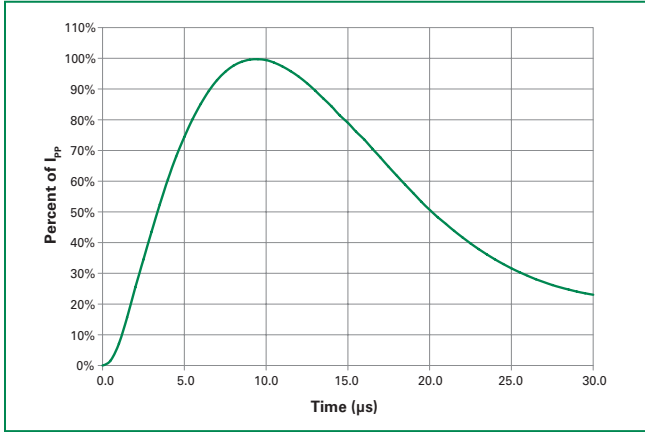

**Insertion Loss of Pin 1 to Pin 2 (I/O to I/O)**

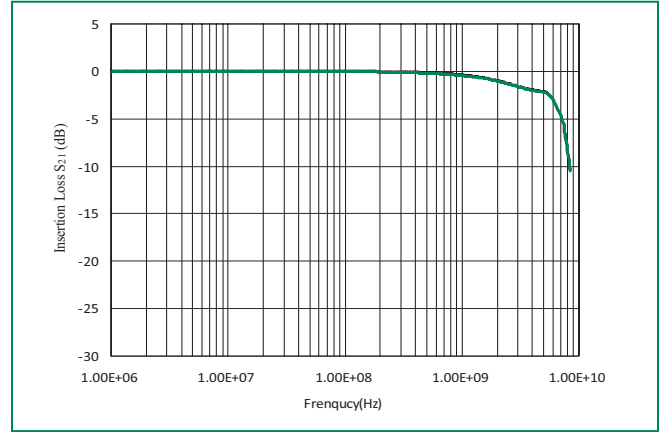

**Capacitance vs. Reverse Bias (Pin 1 or Pin 2 to Pin 3)**

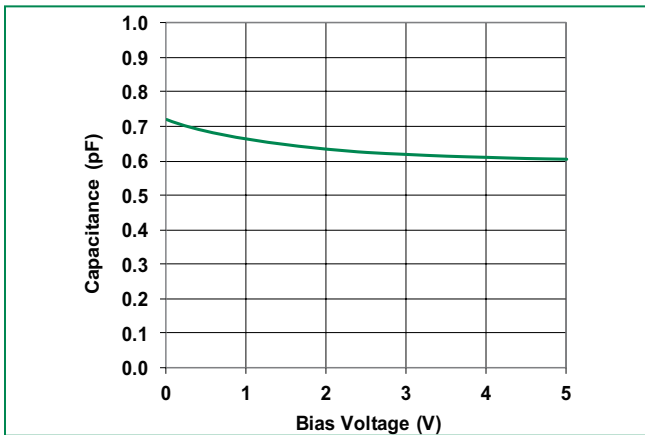

**Capacitance vs. Reverse Bias (I/O-I/O) (Pin 1 to Pin 2)**

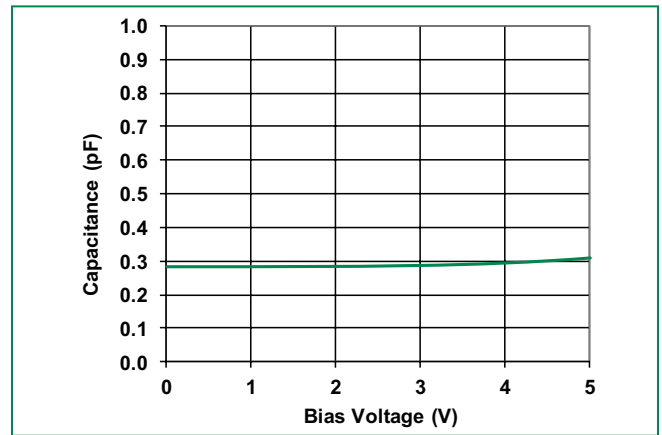

**Transmission Line Pulse (TLP)**

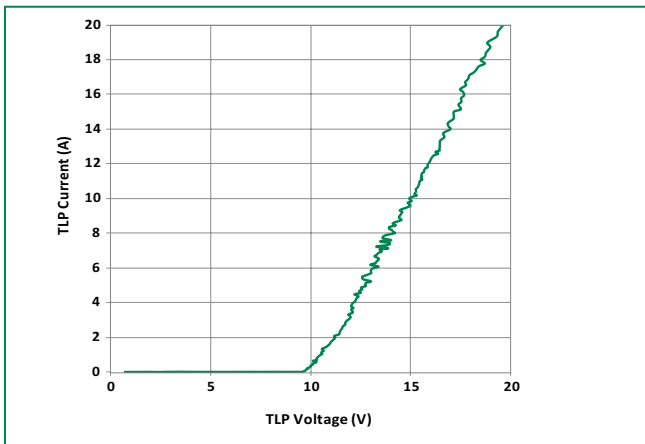

**Product Characteristics**

<b>Lead Plating</b>	Pre-Plated Frame
<b>Lead Material</b>	Copper Alloy
<b>Lead Coplanarity</b>	0.0004 inches (0.102mm)
<b>Substrate material</b>	Silicon
<b>Body Material</b>	Molded Epoxy
<b>Flammability</b>	UL 94 V-0

Notes :

1. All dimensions are in millimeters
2. Dimensions include solder plating.
3. Dimensions are exclusive of mold flash & metal burr.
4. Blo is facing up for mold and facing down for trim/form, i.e. reverse trim/form.
5. Package surface matte finish VDI 11-13.

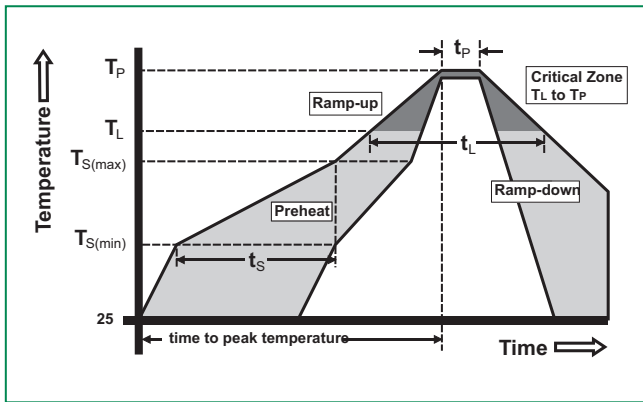

**Soldering Parameters**

Reflow Condition	Pb – Free assembly	
Pre Heat	- Temperature Min ( $T_{s(min)}$ )	150°C
	- Temperature Max ( $T_{s(max)}$ )	200°C
	- Time (min to max) ( $t_s$ )	60 – 180 secs
Average ramp up rate (Liquidus) Temp ( $T_L$ ) to peak	3°C/second max	
$T_{S(max)}$ to $T_L$ - Ramp-up Rate	3°C/second max	
Reflow	- Temperature ( $T_L$ ) (Liquidus)	217°C
	- Temperature ( $t_L$ )	60 – 150 seconds
Peak Temperature ( $T_P$ )	260 <sup>+0/-5</sup> °C	
Time within 5°C of actual peak Temperature ( $t_p$ )	20 – 40 seconds	
Ramp-down Rate	6°C/second max	
Time 25°C to peak Temperature ( $T_P$ )	8 minutes Max.	
Do not exceed	260°C	

**Ordering Information**

Part Number	Package	Size	Marking	Min. Order Qty.
SP0502BXTG	SOT523	1.6x1.6mm	3**	3000

**Part Numbering System**

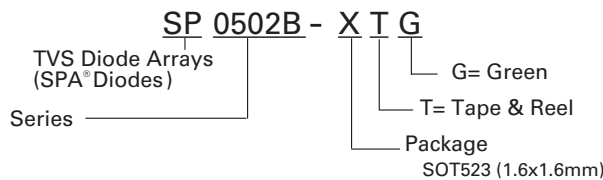

**Part Marking System**

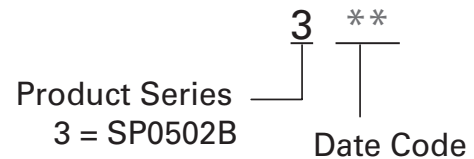

**Package Dimensions – SOT523**

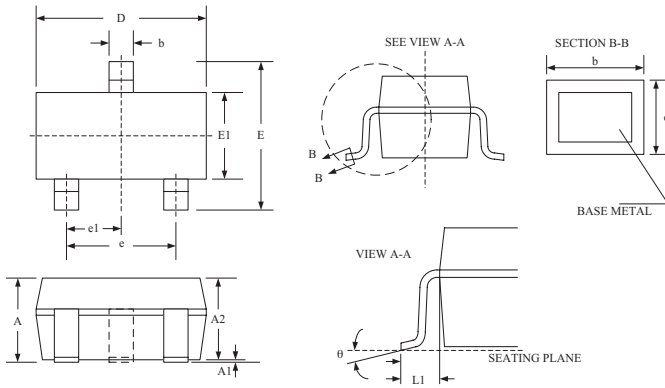

	Millimetres			Inches		
	Min	Typ	Max	Min	Typ	Max
<b>A</b>	0.60	-	0.90	0.023	-	0.035
<b>A1</b>	0.00	-	0.10	0.000	-	0.004
<b>A2</b>	0.60	0.75	0.80	0.023	0.030	0.031
<b>b</b>	0.15	-	0.30	0.005	-	0.012
<b>c</b>	0.10	-	0.20	0.003	-	0.008
<b>D</b>	1.50	1.60	1.70	0.059	0.063	0.067
<b>e</b>	1.00 BSC			0.039 BSC		
<b>e1</b>	0.50 BSC			0.020 BSC		
<b>E</b>	1.45	1.60	1.75	0.057	0.063	0.069
<b>E1</b>	0.75	0.80	0.85	0.029	0.031	0.033
<b>L1</b>	0.22 REF			0.009 RFE		
<b>θ</b>	0°	-	8°	0°	-	8°

**Embossed Carrier Tape & Reel Specification – SOT523**

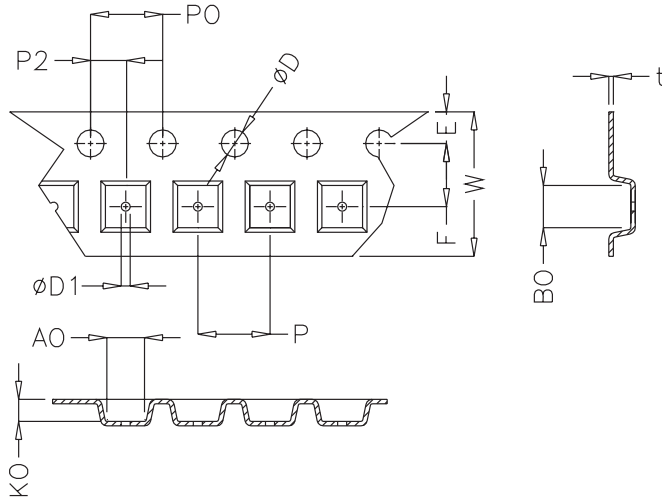

	Millimetres		Inches	
	Min	Max	Min	Max
<b>E</b>	1.65	1.85	0.065	0.073
<b>F</b>	3.45	3.55	0.135	0.139
<b>P2</b>	1.95	2.05	0.077	0.081
<b>D</b>	1.40	1.60	0.055	0.063
<b>D1</b>	0.45	0.55	0.017	0.021
<b>P0</b>	3.90	4.10	0.154	0.161
<b>10P0</b>	40.0+/- 0.20		1.574+/-0.008	
<b>W</b>	7.70	8.10	0.303	0.318
<b>P</b>	3.90	4.10	0.153	0.161
<b>A0</b>	1.73	1.83	0.068	0.072
<b>B0</b>	1.73	1.83	0.068	0.072
<b>K0</b>	0.64	0.74	0.025	0.029
<b>t</b>	0.22 max		0.009 max	

单击下面可查看定价，库存，交付和生命周期等信息

[>>Littelfuse\(美国力特\)](#)