

SP1103C 80A Discrete Bidirectional TVS Diode

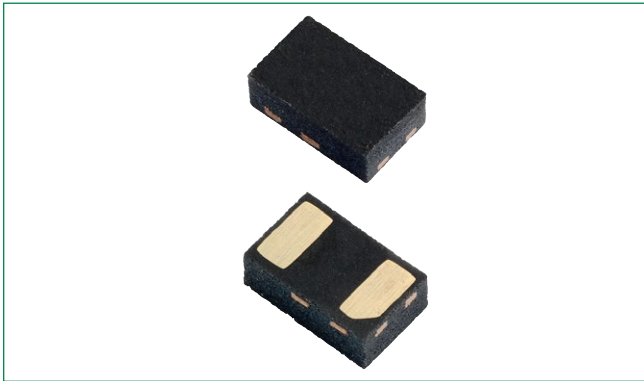

Description

The SP1103C includes TVS diodes fabricated in a proprietary silicon avalanche technology protect each I/O pin to provide a high level of protection for electronic equipment that may experience destructive electrostatic discharges (ESD). These robust diodes can safely absorb repetitive ESD strikes at $\pm 30\text{kV}$ (contact discharge, IEC 61000-4-2) without performance degradation. Additionally, each diode can safely dissipate 80A of 8/20ms surge current (IEC 61000-4-5, 2nd edition) with very low clamping voltages.

Pinout and Functional Block Diagram

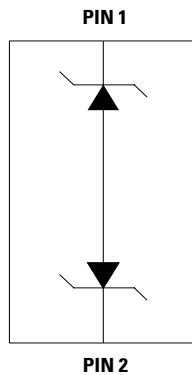

Features

- ESD, IEC 61000-4-2, $\pm 30\text{kV}$ contact, $\pm 30\text{kV}$ air
- EFT, IEC 61000-4-4, 40A (5/50ns)
- Lightning, IEC 61000-4-5 2nd edition, 80A ($t_p=8/20\mu\text{s}$)
- Low clamping voltage
- Low leakage current
- AEC-Q101 qualified
- Moisture Sensitivity Level(MSL -1)
- Halogen free, Lead free and RoHS compliant

Applications

- Switches / Buttons
- Test Equipment / Instrumentation
- Point-of-Sale Terminals
- Medical Equipment
- Notebooks / Desktops / Servers
- Computer Peripherals
- Automotive Electronics

Life Support Note:

Not Intended for Use in Life Support or Life Saving Applications

The products shown herein are not designed for use in life sustaining or life saving applications unless otherwise expressly indicated.

Absolute Maximum Ratings

Symbol	Parameter	Value	Units
P_{pk}	Peak Pulse Power ($t_p=8/20\mu s$)	720	W
T_{OP}	Operating Temperature	-40 to 125	°C
T_{STOR}	Storage Temperature	-55 to 150	°C

CAUTION: Stresses above those listed in "Absolute Maximum Ratings" may cause permanent damage to the component. This is a stress only rating and operation of the component at these or any other conditions above those indicated in the operational sections of this specification is not implied.

SP1103C Electrical Characteristics ($T_{OP}=25^\circ C$)

Parameter	Symbol	Test Conditions	Min	Typ	Max	Units
Reverse Standoff Voltage	V_{RWM}	$I_r \leq 1\mu A$	-	-	3.3	V
Breakdown Voltage	V_{BR}	$I_r = 1mA$	3.4	3.8	5.0	V
Leakage Current	I_{LEAK}	$V_R = 3.3V$	-	-	1.0	μA
Clamp Voltage ¹	V_C	$I_{pp} = 40A, t_p = 8/20\mu s, Fwd$	-	6	-	V
		$I_{pp} = 80A, t_p = 8/20\mu s, Fwd$	-	9	-	V
Dynamic Resistance ²	R_{DYN}	TLP, $t_p = 100ns, I/O$ to GND	-	0.01	-	Ω
Peak Pulse Current	I_{pp}	$t_p = 8/20\mu s$	-	-	80	A
ESD Withstand Voltage ¹	V_{ESD}	IEC 61000-4-2 (Contact Discharge)	± 30	-	-	kV
		IEC 61000-4-2 (Air Discharge)	± 30	-	-	kV
Diode Capacitance ¹	C_D	Reverse Bias=0V, $f=1MHz$	-	130	-	pF

Note:

- Parameter is guaranteed by design and/or component characterization.
- Transmission Line Pulse (TLP) with 100ns width, 2ns rise time, and average window $t_1=70ns$ to $t_2=90ns$

I-V Curve Characteristics

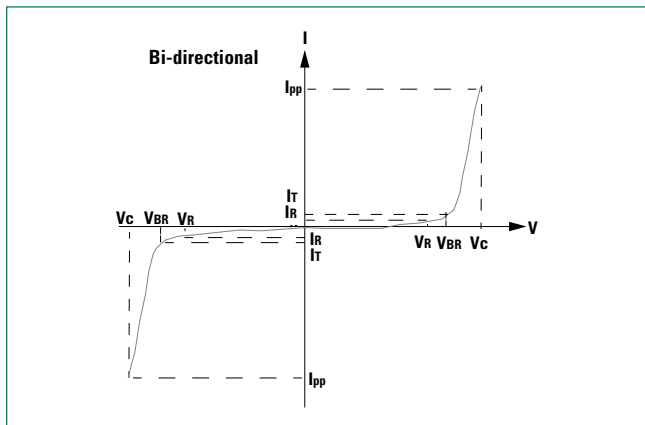

- V_R Stand-off Voltage** – Maximum voltage that can be applied to the TVS without operation
- V_{BR} Breakdown Voltage** – Maximum voltage that flows through the TVS at a specified test current (I_r)
- V_C Clamping Voltage** – Peak voltage measured across the TVS at a specified I_{ppm} (peak impulse current)
- I_r Reverse Leakage Current** – Current measured at V_R

8/20μs Pulse Waveform

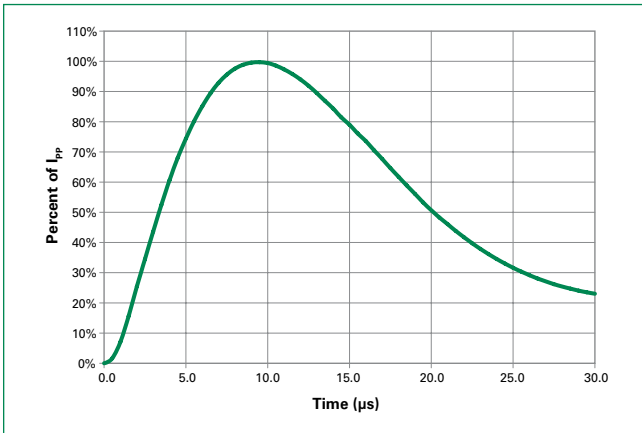

Power Derating Curve

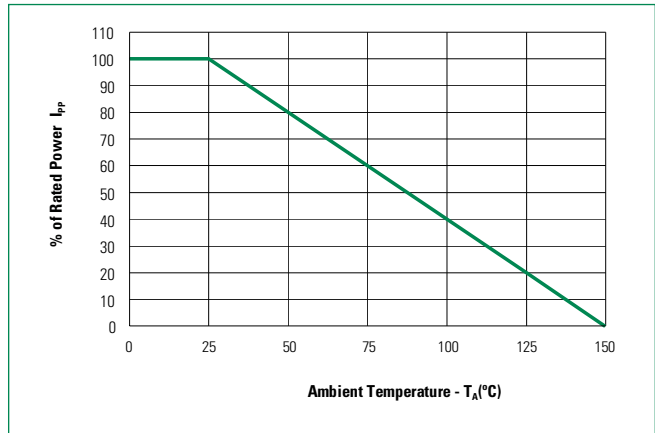

Clamping Voltage vs I_{pp}

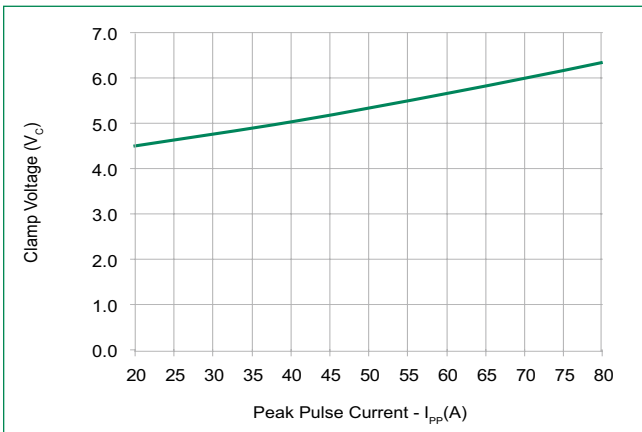

Non-Repetitive Peak Pulse Power vs. Pulse Time

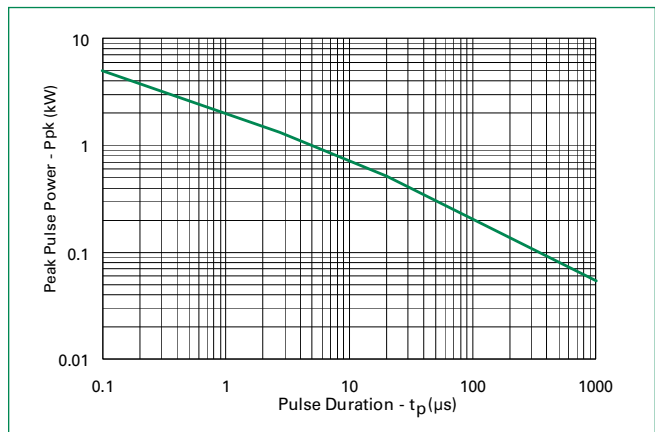

Positive Transmission Line Pulsing (TLP) Plot

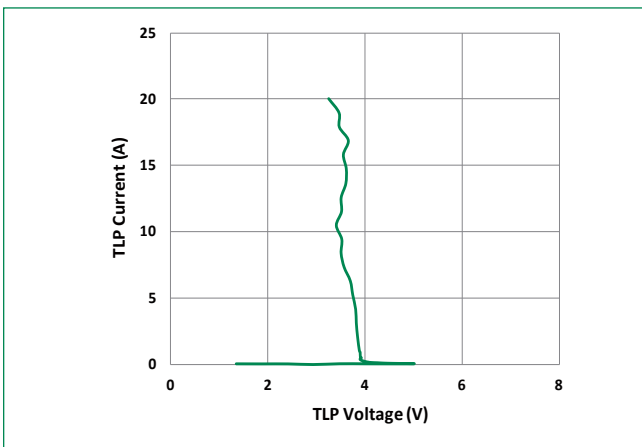

Negative Transmission Line Pulsing (TLP) Plot

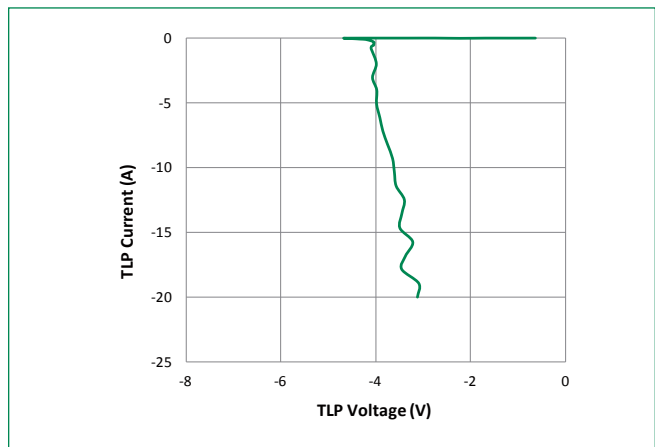

IEC 61000-4-2 +8 kV Contact ESD Clamping Voltage

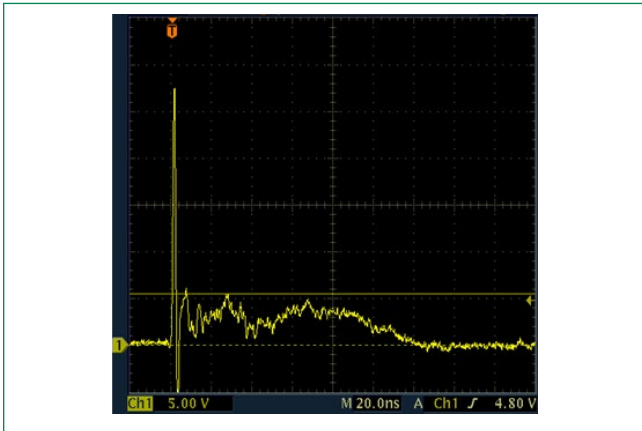

IEC 61000-4-2 -8 kV Contact ESD Clamping Voltage

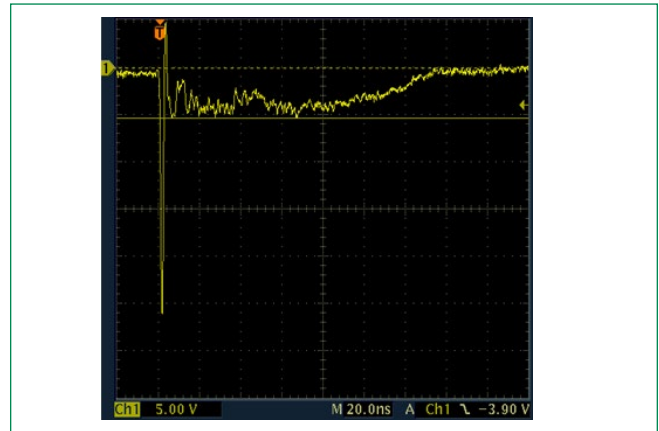

Soldering Parameters

Reflow Condition		Pb – Free assembly
Pre Heat	- Temperature Min ($T_{s(min)}$)	150°C
	- Temperature Max ($T_{s(max)}$)	200°C
	- Time (min to max) (t_s)	60 – 180 secs
Average ramp up rate (Liquidus) Temp (T_L) to peak		3°C/second max
$T_{s(max)}$ to T_L - Ramp-up Rate		3°C/second max
Reflow	- Temperature (T_L) (Liquidus)	217°C
	- Temperature (t_l)	60 – 150 seconds
Peak Temperature (T_p)		260 ^{+0/-5} °C
Time within 5°C of actual peak Temperature (t_p)		20 – 40 seconds
Ramp-down Rate		6°C/second max
Time 25°C to peak Temperature (T_p)		8 minutes Max.
Do not exceed		260°C

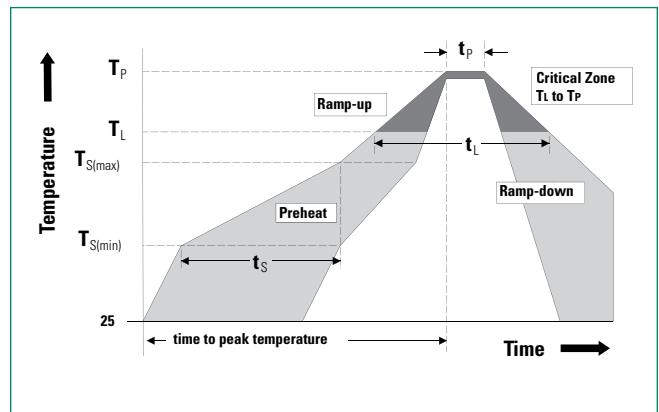

Part Marking System

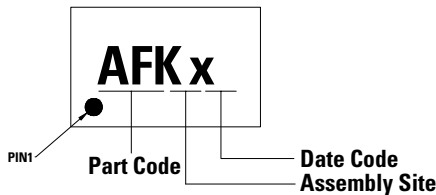

Part Numbering System

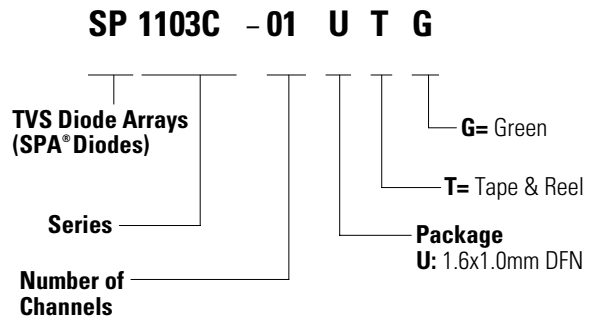

Ordering Information

Part Number	Package	Marking	Min. Order Qty.
SP1103C-01UTG	1.6x1.0mm DFN	AFKx	3000

Package Dimensions

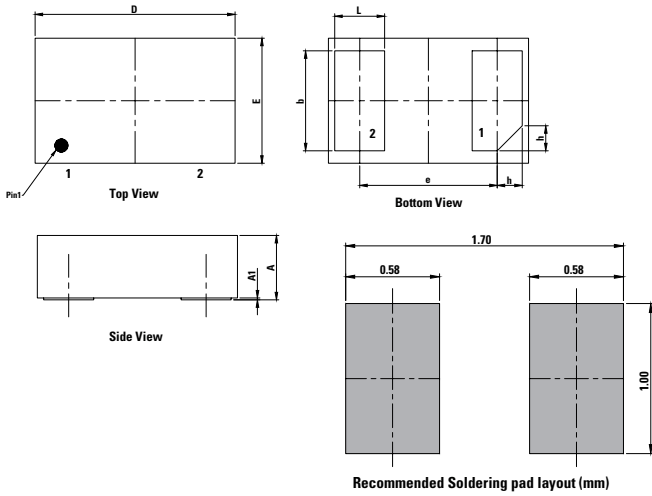

Symbol	1.6x1.0mm DFN		
	Millimeters		
	Min	Nor	Max
A	0.45	0.50	0.55
A1	-	0.02	0.05
D	1.55	1.60	1.65
E	0.95	1.00	1.05
b	0.75	0.80	0.85
L	0.35	0.40	0.45
e	1.10 BSC		
h	0.15	0.20	0.25

Embossed Carrier Tape & Reel Specification

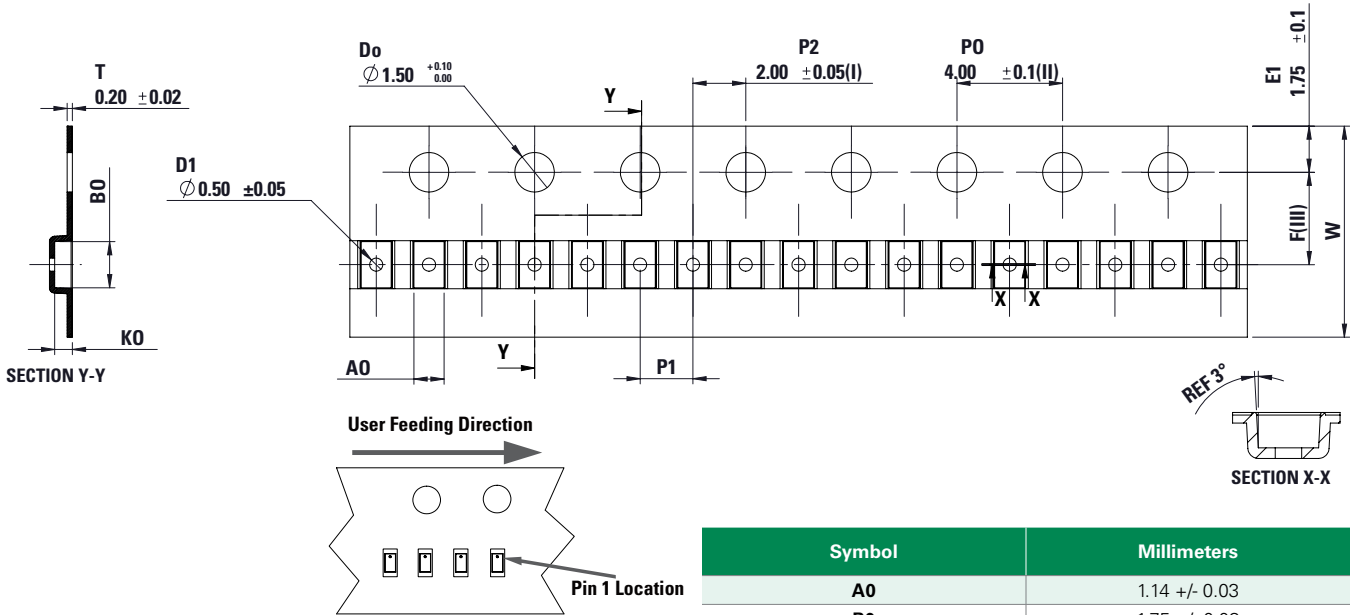

Symbol	Millimeters
A0	1.14 +/- 0.03
B0	1.75 +/- 0.03
K0	0.67 +/- 0.05
F	3.50 +/- 0.05
P1	2.00 +/- 0.10
W	8.00 +/- 0.10

单击下面可查看定价，库存，交付和生命周期等信息

[>>Littelfuse\(美国力特\)](#)