

High Voltage IGBTs

IXGK75N250

IXGX75N250

For Capacitor Discharge Applications

$$V_{CES} = 2500V$$

$$I_{C110} = 75A$$

$$V_{CE(sat)} \leq 2.7V$$

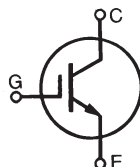

Symbol	Test Conditions	Maximum Ratings	
V_{CES}	$T_J = 25^\circ C$ to $150^\circ C$	2500	V
V_{CGR}	$T_J = 25^\circ C$ to $150^\circ C$, $R_{GE} = 1M\Omega$	2500	V
V_{GES}	Continuous	± 20	V
V_{GEM}	Transient	± 30	V
I_{C25}	$T_C = 25^\circ C$ (Chip Capability)	170	A
I_{C110}	$T_C = 110^\circ C$	75	A
I_{LRMS}	$T_C = 25^\circ C$ (Lead RMS Limit)	160	A
I_{CM}	$T_C = 25^\circ C$, $V_{GE} = 20V$, 1ms	530	A
SSOA (RBSOA)	$V_{GE} = 15V$, $T_{VJ} = 125^\circ C$, $R_G = 1\Omega$ Clamped Inductive Load	$I_{CM} = 200$ @ $0.8 \cdot V_{CES}$	A
P_C	$T_C = 25^\circ C$	780	W
T_J		-55 ... +150	$^\circ C$
T_{JM}		150	$^\circ C$
T_{stg}		-55 ... +150	$^\circ C$
T_L	Maximum Lead Temperature for Soldering	300	$^\circ C$
T_{SOLD}	1.6 mm (0.062 in.) from Case for 10	260	$^\circ C$
M_d	Mounting Torque (IXGK)	1.13/10	Nm/lb.in.
F_c	Mounting Force (IXGX)	20..120/4.5..27	N/lb.
Weight	TO-264	10	g
	PLUS247	6	g

TO-264 (IXGK)

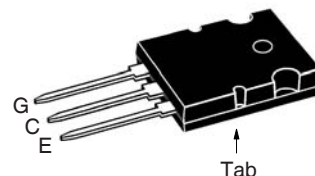

PLUS247™ (IXGX)

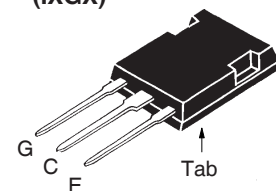

G = Gate E = Emitter
C = Collector Tab = Collector

Features

- Very High Peak Current Capability
- Low Saturation Voltage
- MOS Gate Turn-On
- Rugged NPT Structure
- Molding Epoxies meet UL 94V-0 Flammability Classification

Advantages

- Easy to Mount
- Space Savings
- High Power Density

Applications

- Capacitor Discharge
- Pulser Circuits

Symbol	Test Conditions ($T_J = 25^\circ C$, Unless Otherwise Specified)	Characteristic Values		
		Min.	Typ.	Max.
BV_{CES}	$I_C = 1mA$, $V_{CE} = 0V$	2500		V
$V_{GE(th)}$	$I_C = 4mA$, $V_{CE} = V_{GE}$	3.0		5.0 V
I_{CES}	$V_{CE} = V_{CES}$, $V_{GE} = 0V$ $T_J = 125^\circ C$			50 μA 5 mA
I_{GES}	$V_{CE} = 0V$, $V_{GE} = \pm 20V$			± 200 nA
$V_{CE(sat)}$	$I_C = 75A$, $V_{GE} = 15V$, Note 1			2.7 V
	$I_C = 150A$			3.6 V

Symbol	Test Conditions ($T_J = 25^\circ\text{C}$, Unless Otherwise Specified)	Characteristic Values		
		Min.	Typ.	Max.
g_{fs}	$I_C = 60\text{A}$, $V_{CE} = 10\text{V}$, Note 1	35	58	S
C_{ies}	$V_{CE} = 25\text{V}$, $V_{GE} = 0\text{V}$, $f = 1\text{MHz}$		9000	pF
C_{oes}			345	pF
C_{res}			110	pF
Q_g	$I_C = 75\text{A}$, $V_{GE} = 15\text{V}$, $V_{CE} = 0.5 \cdot V_{CES}$		410	nC
Q_{ge}			63	nC
Q_{gc}			175	nC
$t_{d(on)}$	Resistive Switching Times $I_C = 150\text{A}$, $V_{GE} = 15\text{V}$ $V_{CE} = 1250\text{V}$, $R_G = 1\Omega$		55	ns
t_r			225	ns
$t_{d(off)}$			270	ns
t_f			455	ns
R_{thJC}			0.16	$^\circ\text{C/W}$
R_{thCK}		0.15		$^\circ\text{C/W}$

Note 1. Pulse test, $t \leq 300\mu\text{s}$, duty cycle, $d \leq 2\%$.

*Additional provision for lead-to-lead voltage isolation are required at $V_{CE} > 1200\text{V}$.

PRELIMINARY TECHNICAL INFORMATION

The product presented herein is under development. The Technical Specifications offered are derived from data gathered during objective characterizations of preliminary engineering lots; but also may yet contain some information supplied during a pre-production design evaluation. IXYS reserves the right to change limits, test conditions, and dimensions without notice.

IXYS Reserves the Right to Change Limits, Test Conditions, and Dimensions.

IXYS MOSFETs and IGBTs are covered by one or more of the following U.S. patents: 4,835,592 4,931,844 5,049,961 5,237,481 6,162,665 6,404,065 B1 6,683,344 6,727,585 7,005,734 B2 7,157,338 B2
4,850,072 5,017,508 5,063,307 5,381,025 6,259,123 B1 6,534,343 6,710,405 B2 6,759,692 7,063,975 B2
4,881,106 5,034,796 5,187,117 5,486,715 6,306,728 B1 6,583,505 6,710,463 6,771,478 B2 7,071,537

TO-264 AA (IXGK) Outline

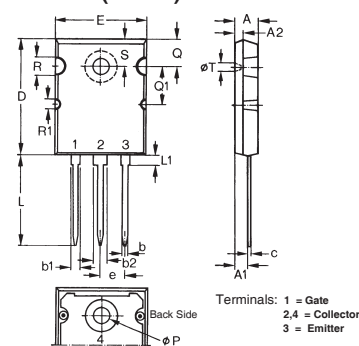

Dim.	Millimeter		Inches	
	Min.	Max.	Min.	Max.
A	4.82	5.13	.190	.202
A1	2.54	2.89	.100	.114
A2	2.00	2.10	.079	.083
b	1.12	1.42	.044	.056
b1	2.39	2.69	.094	.106
b2	2.90	3.09	.114	.122
c	0.53	0.83	.021	.033
D	25.91	26.16	1.020	1.030
E	19.81	19.96	.780	.786
e	5.46 BSC		.215 BSC	
J	0.00	0.25	.000	.010
K	0.00	0.25	.000	.010
L	20.32	20.83	.800	.820
L1	2.29	2.59	.090	.102
P	3.17	3.66	.125	.144
Q	6.07	6.27	.239	.247
Q1	8.38	8.69	.330	.342
R	3.81	4.32	.150	.170
R1	1.78	2.29	.070	.090
S	6.04	6.30	.238	.248
T	1.57	1.83	.062	.072

PLUS247™ (IXGX) Outline

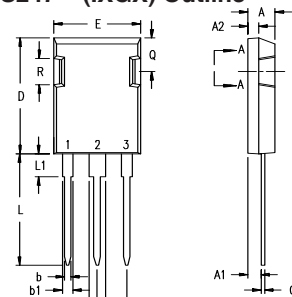

Terminals: 1 - Gate
2 - Collector
3 - Emitter

Dim.	Millimeter		Inches	
	Min.	Max.	Min.	Max.
A	4.83	5.21	.190	.205
A ₁	2.29	2.54	.090	.100
A ₂	1.91	2.16	.075	.085
b	1.14	1.40	.045	.055
b ₁	1.91	2.13	.075	.084
b ₂	2.92	3.12	.115	.123
C	0.61	0.80	.024	.031
D	20.80	21.34	.819	.840
E	15.75	16.13	.620	.635
e	5.45 BSC		.215 BSC	
L	19.81	20.32	.780	.800
L1	3.81	4.32	.150	.170
Q	5.59	6.20	.220	0.244
R	4.32	4.83	.170	.190

Fig. 1. Output Characteristics @ $T_J = 25^\circ\text{C}$

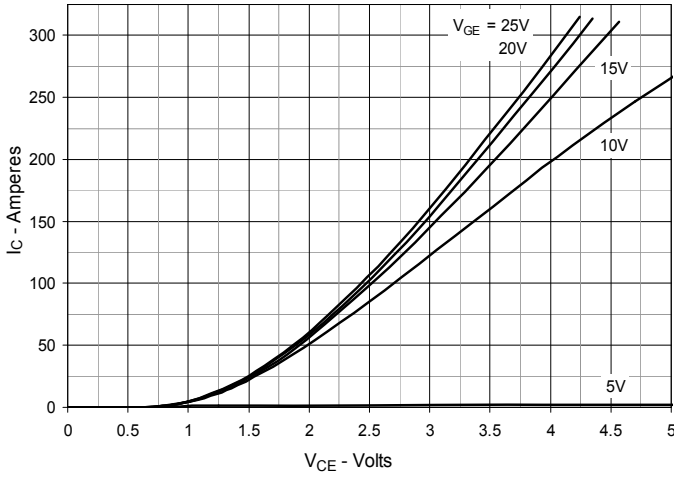

Fig. 2. Output Characteristics @ $T_J = 125^\circ\text{C}$

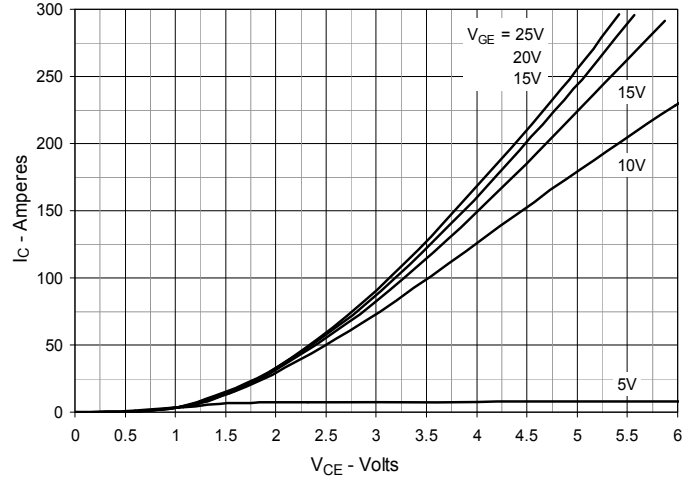

Fig. 3. Dependence of $V_{CE(sat)}$ on Junction Temperature

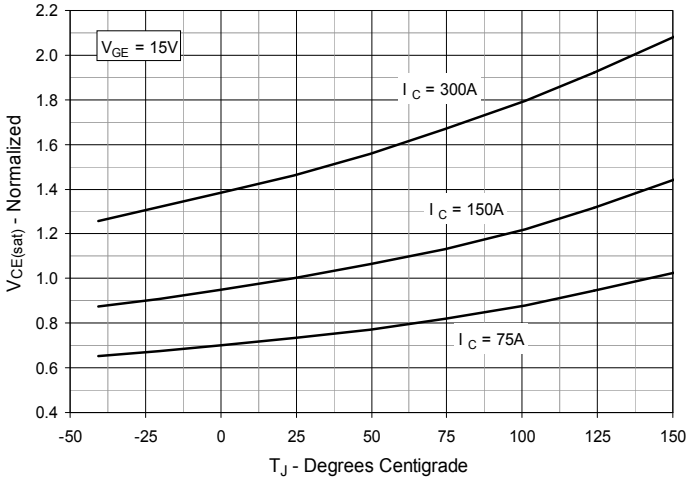

Fig. 4. Collector-to-Emitter Voltage vs. Gate-to-Emitter Voltage

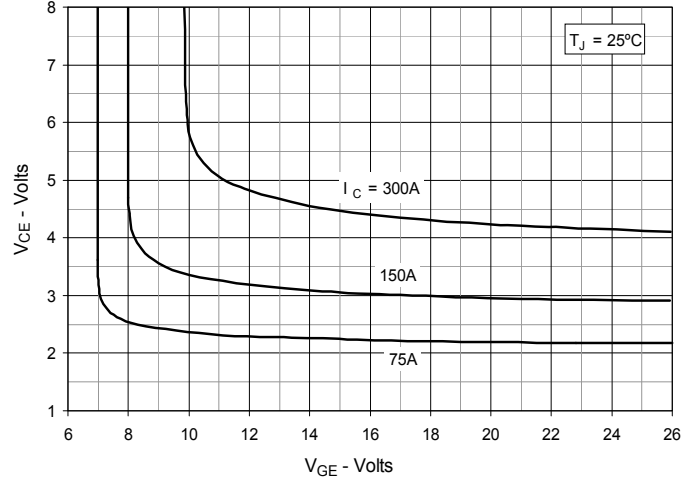

Fig. 5. Input Admittance

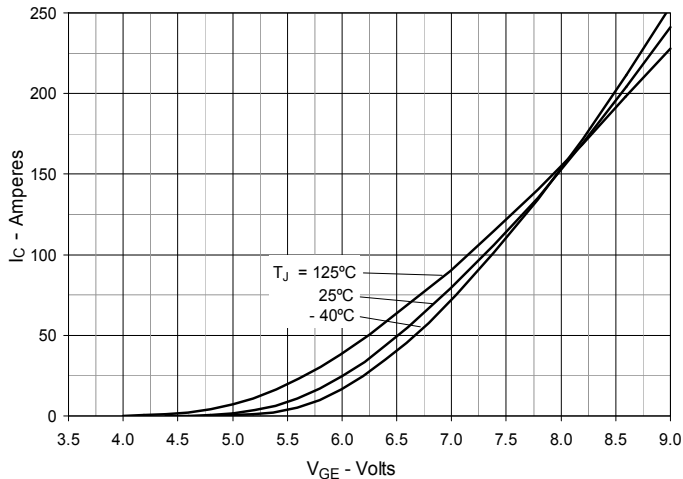

Fig. 6. Transconductance

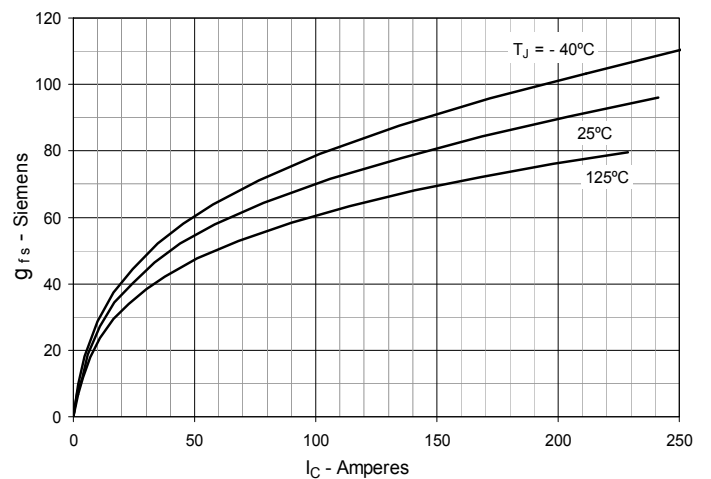

Fig. 7. Gate Charge

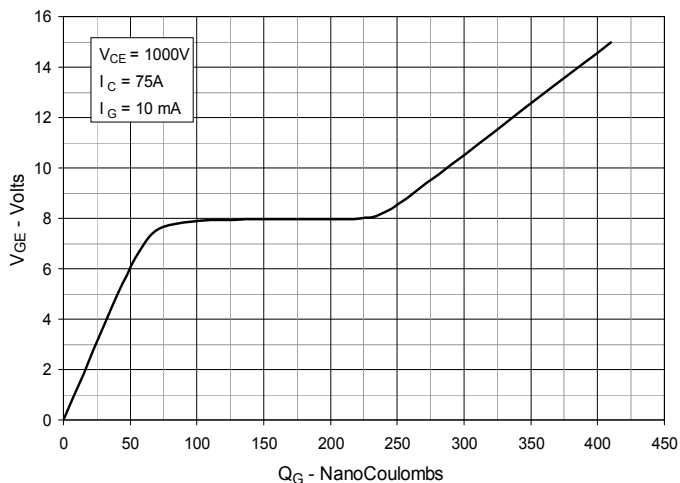

Fig. 8. Capacitance

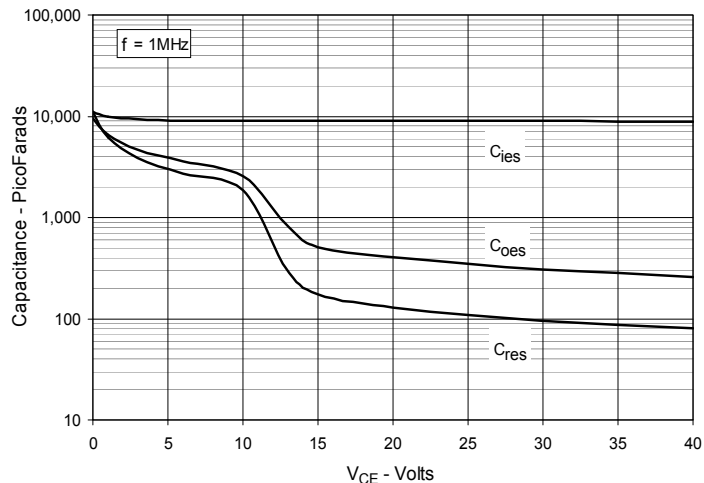

Fig. 9. Reverse-Bias Safe Operating Area

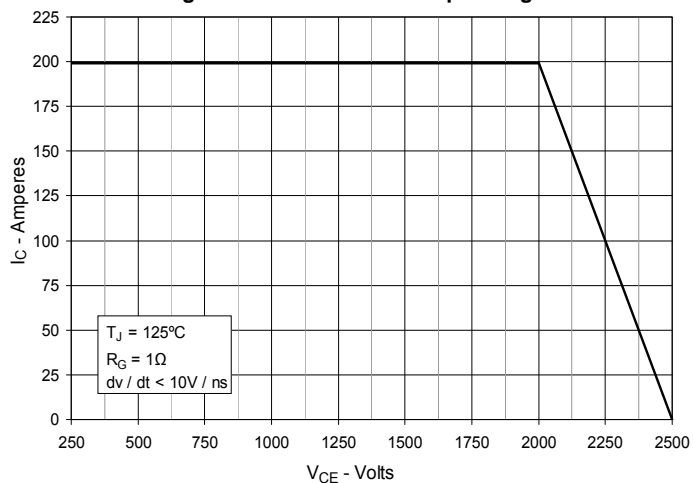

Fig. 10. Maximum Transient Thermal Impedance

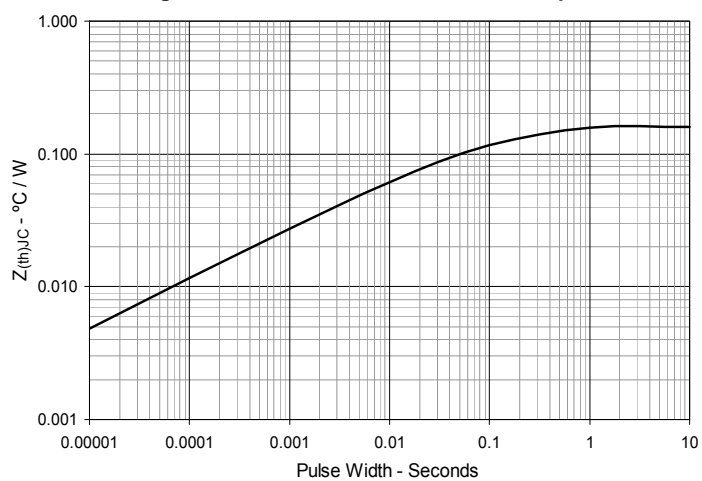

Fig. 11. Resistive Turn-on Rise Time vs. Junction Temperature

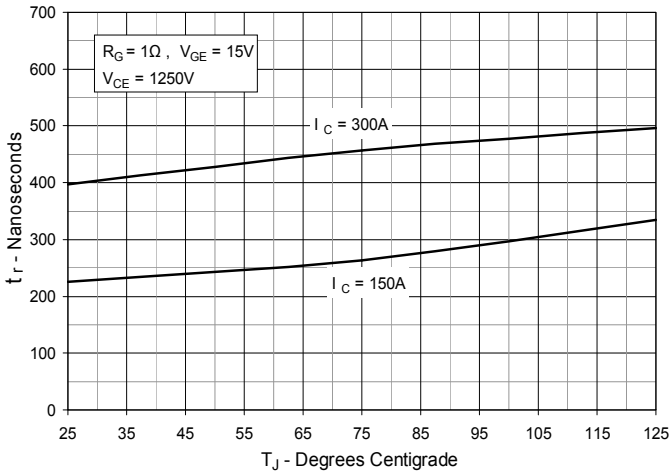

Fig. 12. Resistive Turn-on Rise Time vs. Collector Current

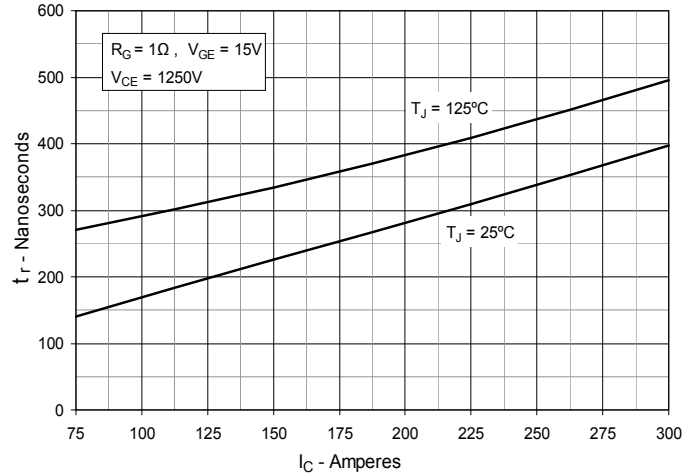

Fig. 13. Resistive Turn-on Switching Times vs. Gate Resistance

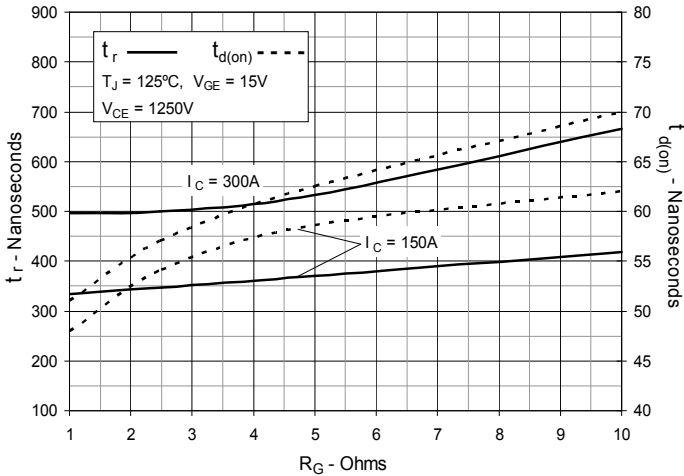

Fig. 14. Resistive Turn-off Switching Times vs. Junction Temperature

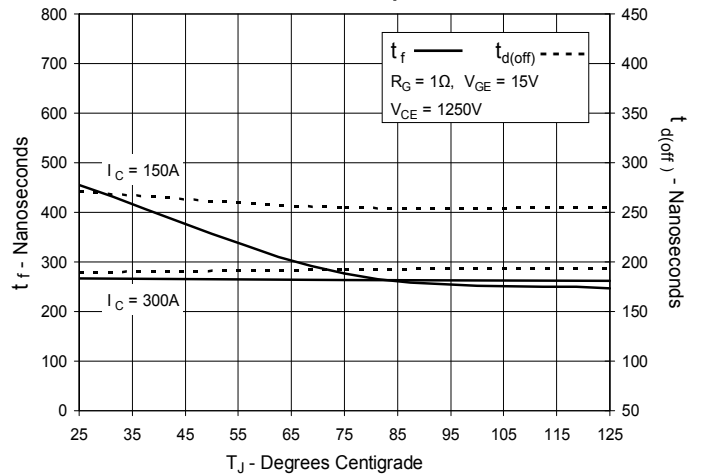

Fig. 15. Resistive Turn-off Switching Times vs. Collector Current

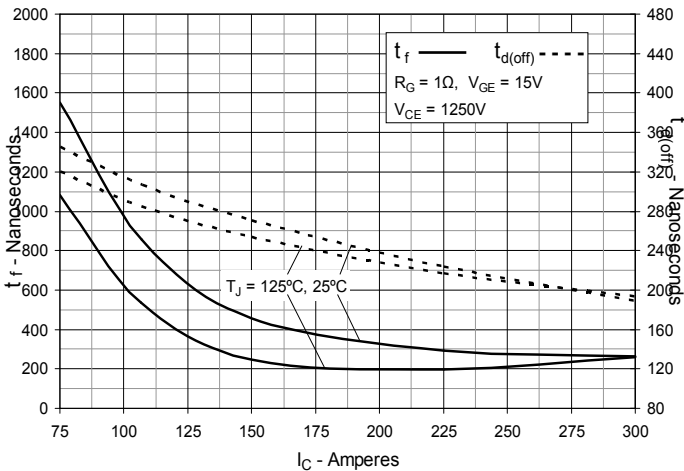
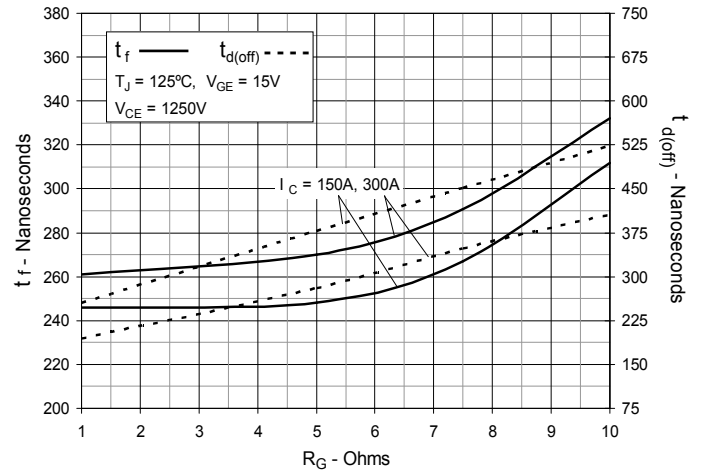

Fig. 16. Resistive Turn-off Switching Times vs. Gate Resistance





Disclaimer Notice - Information furnished is believed to be accurate and reliable. However, users should independently evaluate the suitability of and test each product selected for their own applications. Littelfuse products are not designed for, and may not be used in, all applications. Read complete Disclaimer Notice at www.littelfuse.com/disclaimer-electronics.

单击下面可查看定价，库存，交付和生命周期等信息

[>>Littelfuse\(美国力特\)](#)