

SP4208 series 3.0pF, 30A Discrete TVS Diode



Description

The SP4208 components integrate low capacitance steering diodes with one or two avalanche breakdown diodes for unidirectional or bidirectional protection, respectively, to protect against ESD and lightning induced surge events. These components can safely absorb up to 30A per IEC 61000-4-5 2nd edition ($t_p=8/20\mu s$) without performance degradation and a minimum $\pm 30kV$ ESD per IEC 61000-4-2 International Standard. The low loading capacitance and high surge capability make it ideal for protecting telecommunication ports such as Ethernet and other high speed data interfaces.

Pinout

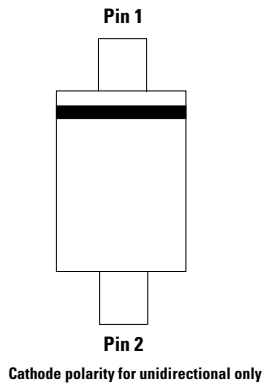

Features

- ESD, IEC 61000-4-2, $\pm 30kV$ contact, $\pm 30kV$ air
- EFT, IEC 61000-4-4, 40A (5/50ns)
- Lightning, IEC 61000-4-5 2nd edition, 30A ($t_p=8/20\mu s$)
- Low capacitance of 3.0pF (@ $V_R=0V$)
- Low leakage current
- Unidirectional and bidirectional configuration
- Small SOD323 package fits 0805 footprints
- AEC-Q101 qualified
- Halogen free, lead free and RoHS compliant
- Moisture Sensitivity Level(MSL -1)

Functional Block Diagram

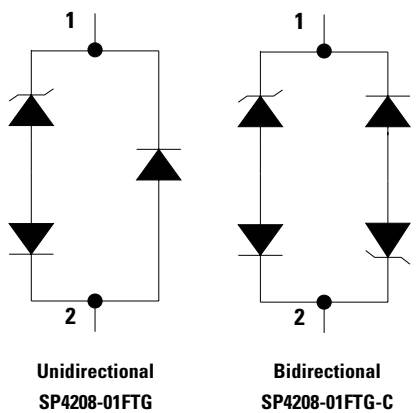

Applications

- 10/100/1000 2.5 and 5 Gigabit Ethernet
- Medical Equipment
- Computers and Peripherals
- Instrumentation

Life Support Note:
Not Intended for Use in Life Support or Life Saving Applications
The products shown herein are not designed for use in life sustaining or life saving applications unless otherwise expressly indicated.

Absolute Maximum Ratings

Symbol	Parameter	Value	Units
I_{PP}	Peak Current ($t_p=8/20\mu s$)	30	A
P_{PK}	Peak Pulse Power ($t_p=8/20\mu s$)	750	W
T_{OP}	Operating Temperature	-40 to 125	°C
T_{STOR}	Storage Temperature	-55 to 150	°C

CAUTION: Stresses above those listed in "Absolute Maximum Ratings" may cause permanent damage to the component. This is a stress only rating and operation of the component at these or any other conditions above those indicated in the operational sections of this specification is not implied.

Electrical Characteristics ($T_{OP}=25^\circ C$)

Parameter	Symbol	Test Conditions	Min	Typ	Max	Units
Breakdown Voltage	V_{BD}	$I_R=1mA$	-	9.5	-	V
Reverse Standoff Voltage	V_{RWM}	$I_R \leq 1\mu A$	-	-	8.0	V
Leakage Current	I_{LEAK}	$V_R=8.0V$	-	0.02	0.5	μA
Clamp Voltage ¹	V_C	$I_{PP}=1A, t_p=8/20\mu s, Fwd$	-	11.5	-	V
		$I_{PP}=17A, t_p=8/20\mu s, Fwd$	-	19	-	V
		$I_{PP}=30A, t_p=8/20\mu s, Fwd$	-	25	-	V
Dynamic Resistance ²	R_{DYN}	TLP, $t_P=100ns, I/O$ to GND	-	0.37	-	Ω
ESD Withstand Voltage ¹	V_{ESD}	IEC 61000-4-2 (Contact Discharge)	± 30	-	-	kV
		IEC 61000-4-2 (Air Discharge)	± 30	-	-	kV
Diode Capacitance ¹	C_D	Reverse Bias=0V, $f=1MHz$	-	3.0	-	pF

Note:

- Parameter is guaranteed by design and/or component characterization.
- Transmission Line Pulse (TLP) with 100ns width, 2ns rise time, and average window $t_1=70ns$ to $t_2=90ns$

8/20 μs Pulse Waveform

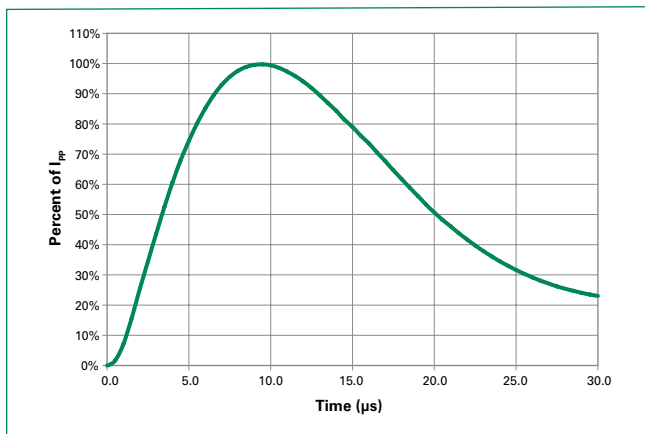

Positive Transmission Line Pulsing (TLP) Plot

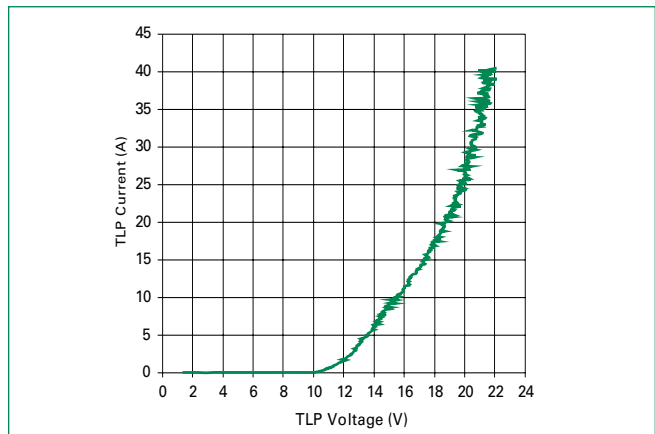

Non-Repetitive Peak Pulse Power vs. Pulse Time

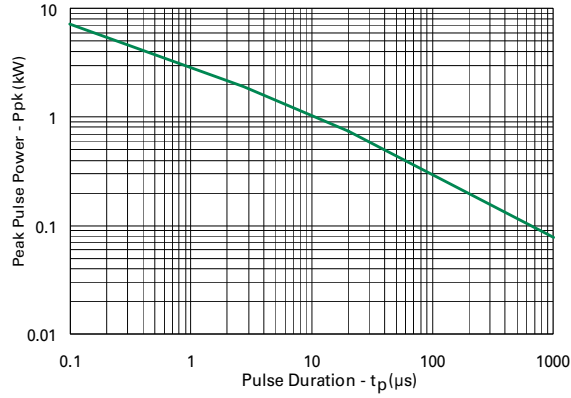

Clamping Voltage vs I_{pp} 8/20μS waveshape

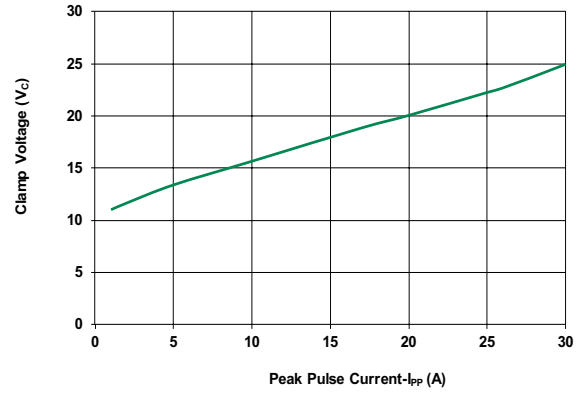

Capacitance vs. Reverse Bias

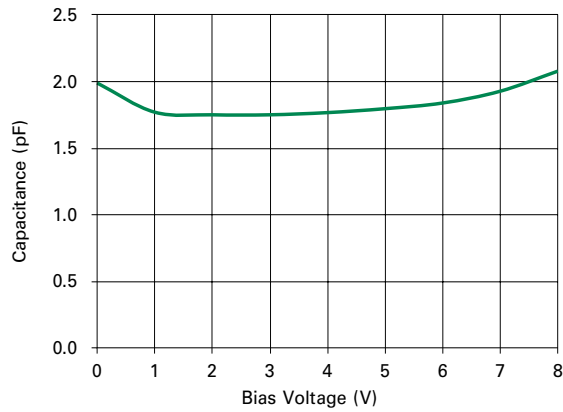

IEC 61000-4-2 +8 kV Contact ESD Clamping Voltage

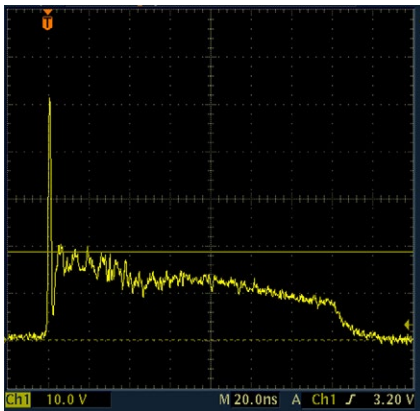

IEC 61000-4-2 -8 kV Contact ESD Clamping Voltage

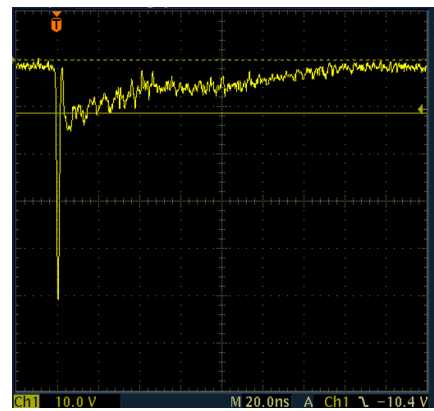

Soldering Parameters

Reflow Condition		Pb – Free assembly
Pre Heat	- Temperature Min ($T_{s(min)}$)	150°C
	- Temperature Max ($T_{s(max)}$)	200°C
	- Time (min to max) (t_s)	60 – 180 secs
Average ramp up rate (Liquidus) Temp (T_L) to peak		3°C/second max
$T_{s(max)}$ to T_L - Ramp-up Rate		3°C/second max
Reflow	- Temperature (T_L) (Liquidus)	217°C
	- Temperature (t_t)	60 – 150 seconds
Peak Temperature (T_p)		260 ^{+0/-5} °C
Time within 5°C of actual peak Temperature (t_p)		20 – 40 seconds
Ramp-down Rate		6°C/second max
Time 25°C to peak Temperature (T_p)		8 minutes Max.
Do not exceed		260°C

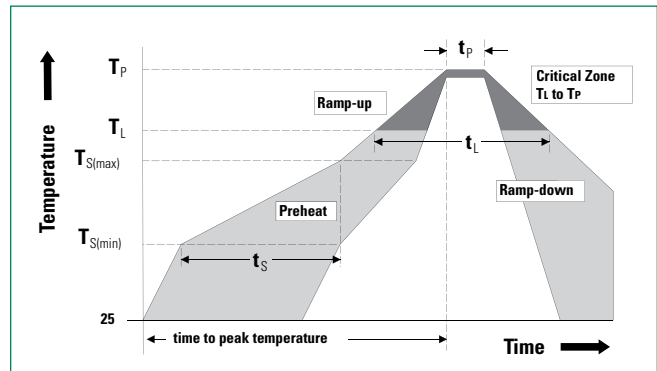

Product Characteristics

Lead Plating	Matte Tin
Lead Material	Iron Alloy
Lead Coplanarity	0.004 inches(0.102mm)
Substrate material	Silicon
Body Material	Molded Compound
Flammability	UL Recognized compound meeting flammability rating V-0

Notes :

1. All dimensions are in millimeters
2. Dimensions include solder plating.
3. Dimensions are exclusive of mold flash & metal burr.

Part Marking System



A= Part Code
X= Assembly Site
Y= Date Code



B= Part Code
X= Assembly Site
Y= Date Code

Part Numbering System

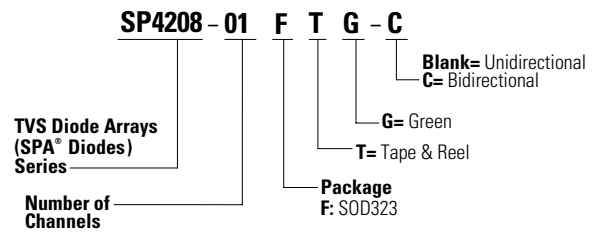

Ordering Information

Part Number	Package	Marking	Min. Order Qty.
SP4208-01FTG	SOD323	Axx	3000
SP4208-01FTG-C	SOD323	Bxx	3000

Package Dimensions -SOD323

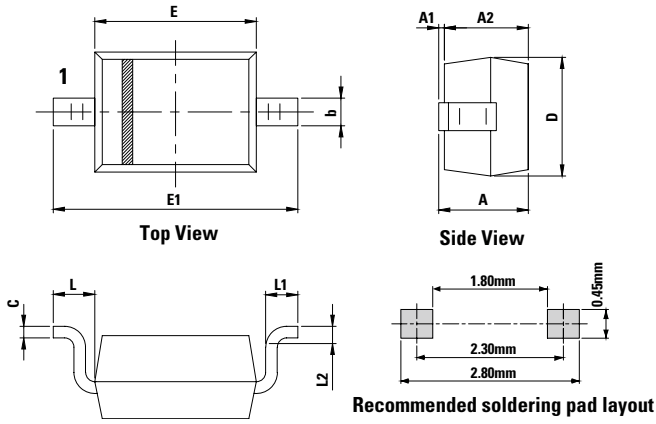

Symbol	Millimeters		
	Min	Nor	Max
A	0.80	1.00	1.14
A1	0	-	0.10
A2	0.80	0.95	1.04
b	0.25	0.30	0.35
c	0.08	-	0.15
D	1.15	1.30	1.45
E	1.60	1.75	1.90
E1	2.44	2.55	2.75
L	0.475 REF		
L1	0.22	0.35	0.45
L2	0.20 BSC		

Embossed Carrier Tape & Reel Specification – SOD323

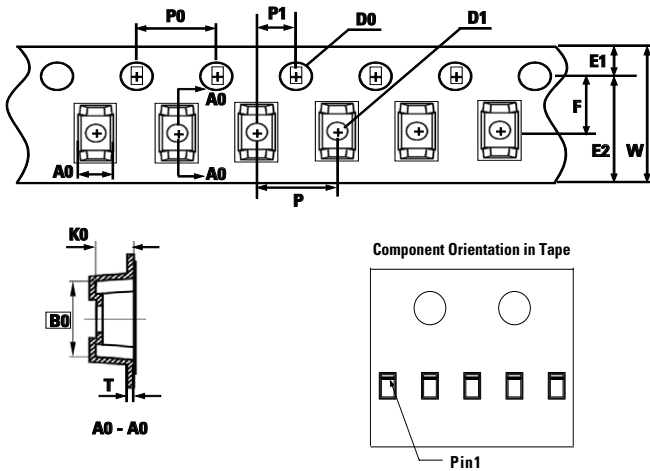

Symbol	Millimeters
A0	1.46+/-0.10
B0	2.90+/-0.10
W	8.0+0.3/-0.10
D0	1.50+0.10
D1	0.45min/1.15max
E1	1.75+/-0.10
E2	-
F	3.50+/-0.10
P0	4.00+/-0.10
P	4.00+/-0.10
P1	2.00+/-0.05
K0	1.25+/-0.10
T	0.254+/-0.02

8mm TAPE AND REEL

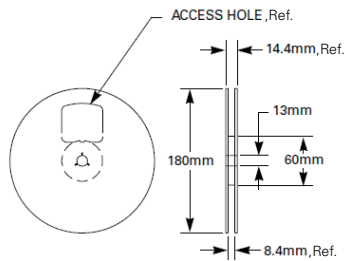

单击下面可查看定价，库存，交付和生命周期等信息

[>>Littelfuse\(美国力特\)](#)