

# POWR-SPEED® Fuse

## L70QS SERIES HIGH-SPEED ROUND BODY

700 V ac/dc • Very Fast Acting • 35–800 A



### Description

The L70QS series is a next generation high-speed fuse for the protection of power semiconductor devices and is designed in the traditional North American bolted style package.

L70QS series high-speed fuses are extremely current limiting and are used to protect power converters, drives and control circuit applications. Designed with lower  $I^2t$  performance characteristics, these fuses provide balanced performance to extend longevity while lowering potentially damaging heat energy to the devices being protected.

In addition L70QS series fuses have been designed with a universal mounting option to meet customer requirements for installation into a variety of application configurations

Littelfuse POWR-SPEED products offer optimized circuit protection at the extremely fast speed required to protect modern day, sensitive, high-power semiconductor devices. Such products are commonly found in various industries including pulp and paper industries, cranes and heavy-lifting equipment, processing industries, wastewater treatment plants and large factories and MRO facilities.

### Features

- Compliance with US and Canadian requirements
- Traditional North American bolted style dimensions
- Class aR performance
- Direct bus-bar mount or stud mount design
- Halogen free, RoHS and REACH Compliant

### Applications

- Power converters (inverters, rectifiers)
- Power supplies
- UPS
- Variable speed drives
- Control circuits
- Soft starters

### Specifications

<b>Voltage Rating</b>	Ac: 700 V Dc: 700 V
<b>Amperage Rating</b>	35–800 A
<b>Interrupting Rating</b>	Ac: 200 kA Dc: 50 kA
<b>Time Constant</b>	10 ms
<b>Material</b>	Body: melamine Caps: copper alloy (silver plated)
<b>Approvals</b>	UL Recognized (E71611) cURus (E71611)
<b>Environmental</b>	RoHS Compliant, REACH
<b>Country of Origin</b>	Mexico
<b>Operating Temperature</b>	-55 °C to +125 °C
<b>Storage Temperature</b>	Up to 35 °C with relative humidity <65 %

### Part Numbering System

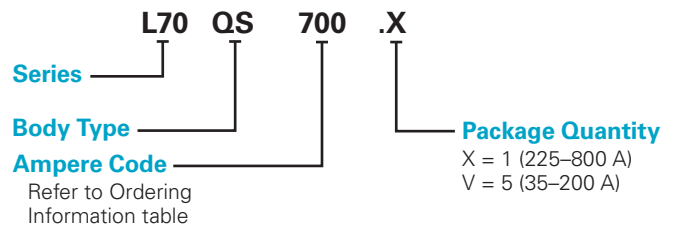

SERIES	BODY TYPE	AMPERE CODE	PACKAGE QUANTITY	CATALOG NUMBER	ORDERING NUMBER
L70	QS	700	1	L70QS700	L70QS700.X

### Recommended Fuse Blocks

LSCR001 (35–100 A)  
LSCR002 (125–800 A)



### Web Resources

Download technical documents: [Littelfuse.com/L70QS](http://Littelfuse.com/L70QS)

*Note: high-speed fuses are designed for fixed installations. They are not intended for use in moving vehicle applications.*

# POWR-SPEED® Fuse

## L70QS SERIES HIGH-SPEED ROUND BODY

### Electrical Specifications

CATALOG NUMBER	AMPERAGE RATING	VOLTAGE RATING		INTERRUPT RATING		MELTING (PRE-ARC) I <sup>2</sup> T (A <sup>2</sup> s)	TOTAL CLEARING I <sup>2</sup> T (A <sup>2</sup> s)	TOTAL CLEARING I <sup>2</sup> T (A <sup>2</sup> s)	WATTS LOSS AT 80 % RATED CURRENT	WATTS LOSS AT 100 % RATED CURRENT
		AC	DC	AC	DC		200 kA @ 700 V AC	50 kA @ 700 V DC	(W)	(W)
L70QS035	35	700	700	200 kA	50 kA	129	332	308	5	8
L70QS040	40	700	700	200 kA	50 kA	153	599	416	6	9
L70QS050	50	700	700	200 kA	50 kA	196	711	588	6	12
L70QS060	60	700	700	200 kA	50 kA	269	1,233	678	9	15
L70QS070	70	700	700	200 kA	50 kA	359	1,575	1,075	10	20
L70QS080	80	700	700	200 kA	50 kA	452	2,755	1,415	12	22
L70QS090	90	700	700	200 kA	50 kA	625	3,365	1,920	13	25
L70QS100	100	700	700	200 kA	50 kA	966	3,747	2,347	15	30
L70QS125	125	700	700	200 kA	50 kA	2,208	8,795	5,570	13	24
L70QS150	150	700	700	200 kA	50 kA	3,026	13,650	8,195	17	32
L70QS175	175	700	700	200 kA	50 kA	4,219	19,550	11,650	20	38
L70QS200	200	700	700	200 kA	50 kA	5,529	22,067	16,100	22	42
L70QS225	225	700	700	200 kA	50 kA	9,226	34,900	25,400	22	40
L70QS250	250	700	700	200 kA	50 kA	10,999	43,750	31,650	27	46
L70QS300	300	700	700	200 kA	50 kA	16,296	64,400	45,500	31	57
L70QS350	350	700	700	200 kA	50 kA	24,778	91,500	65,250	35	67
L70QS400	400	700	700	200 kA	50 kA	34,225	110,667	94,666	41	79
L70QS450	450	700	700	200 kA	50 kA	38,946	145,500	113,500	45	81
L70QS500	500	700	700	200 kA	50 kA	42,747	173,000	125,500	56	112
L70QS600	600	700	700	200 kA	50 kA	67,363	220,333	179,667	67	138
L70QS700	700	700	700	200 kA	50 kA	99,387	368,000	298,000	72	138
L70QS800	800	700	700	200 kA	50 kA	156,137	466,333	415,333	76	142

### Ordering Information

SERIES	AMPERAGE RATING	AMPERE CODE	CATALOG NUMBER	ORDERING NUMBER	PACK QUANTITY	UPC
L70QS	35	035	L70QS035	L70QS035.V	5 Pcs/ Box	07945886015
L70QS	40	040	L70QS040	L70QS040.V	5 Pcs/ Box	07945886016
L70QS	50	050	L70QS050	L70QS050.V	5 Pcs/ Box	07945886017
L70QS	60	060	L70QS060	L70QS060.V	5 Pcs/ Box	07945886018
L70QS	70	070	L70QS070	L70QS070.V	5 Pcs/ Box	07945886019
L70QS	80	080	L70QS080	L70QS080.V	5 Pcs/ Box	07945886020
L70QS	90	090	L70QS090	L70QS090.V	5 Pcs/ Box	07945886021
L70QS	100	100	L70QS100	L70QS100.V	5 Pcs/ Box	07945886022
L70QS	125	125	L70QS125	L70QS125.V	5 Pcs/ Box	07945886023
L70QS	150	150	L70QS150	L70QS150.V	5 Pcs/ Box	07945886024
L70QS	175	175	L70QS175	L70QS175.V	5 Pcs/ Box	07945886025
L70QS	200	200	L70QS200	L70QS200.V	5 Pcs/ Box	07945886026
L70QS	225	225	L70QS225	L70QS225.X	1 Pc/ Box	07945886027
L70QS	250	250	L70QS250	L70QS250.X	1 Pc/ Box	07945886028
L70QS	300	300	L70QS300	L70QS300.X	1 Pc/ Box	07945886029
L70QS	350	350	L70QS350	L70QS350.X	1 Pc/ Box	07945886030
L70QS	400	400	L70QS400	L70QS400.X	1 Pc/ Box	07945886031
L70QS	450	450	L70QS450	L70QS450.X	1 Pc/ Box	07945886032
L70QS	500	500	L70QS500	L70QS500.X	1 Pc/ Box	07945886033
L70QS	600	600	L70QS600	L70QS600.X	1 Pc/ Box	07945886034
L70QS	700	700	L70QS700	L70QS700.X	1 Pc/ Box	07945886035
L70QS	800	800	L70QS800	L70QS800.X	1 Pc/ Box	07945886036

# POWR-SPEED® Fuse

## L70QS SERIES HIGH-SPEED ROUND BODY

### Dimensions Millimeters [inches]

Document Number: OL-L70QS000

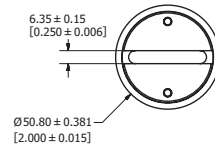
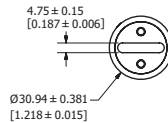
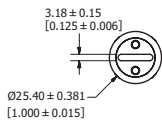
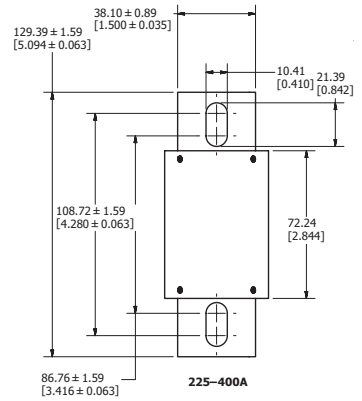
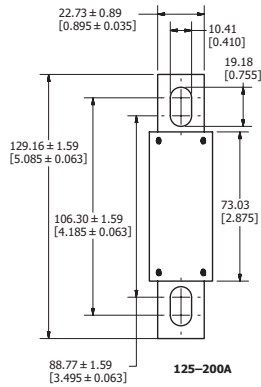
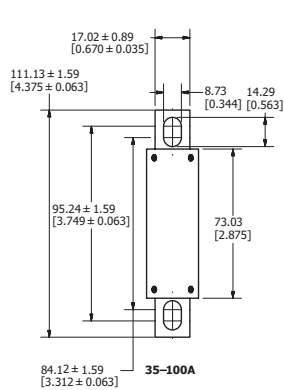

Stud Size: M8 (5/16")

Recommended Torque: 15 Nm (132.76 in-lb)

Stud Size: M8 (5/16")

Recommended Torque: 15 Nm (132.76 in-lb)

Stud Size: M8 (5/16")

Recommended Torque: 15 Nm (132.76 in-lb)

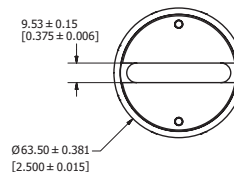
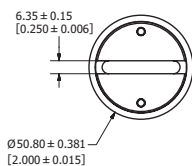
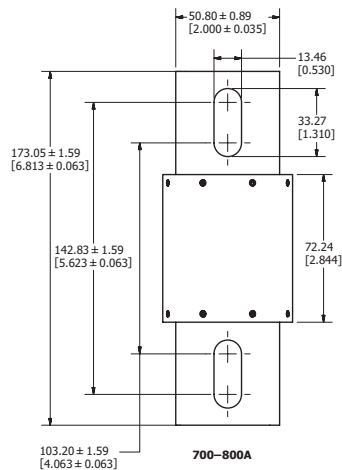
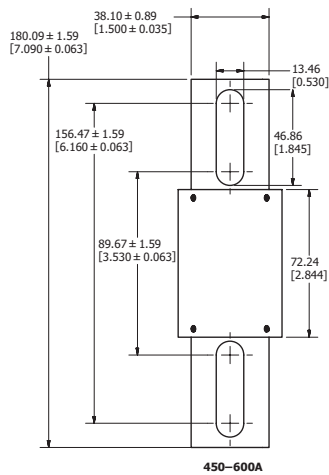

Stud Size: M12 (1/2")

Recommended Torque: 54 Nm (477.94 in-lb)

Stud Size: M12 (1/2")

Recommended Torque: 54 Nm (477.94 in-lb)

**Time Current Curve**

L70QS Series

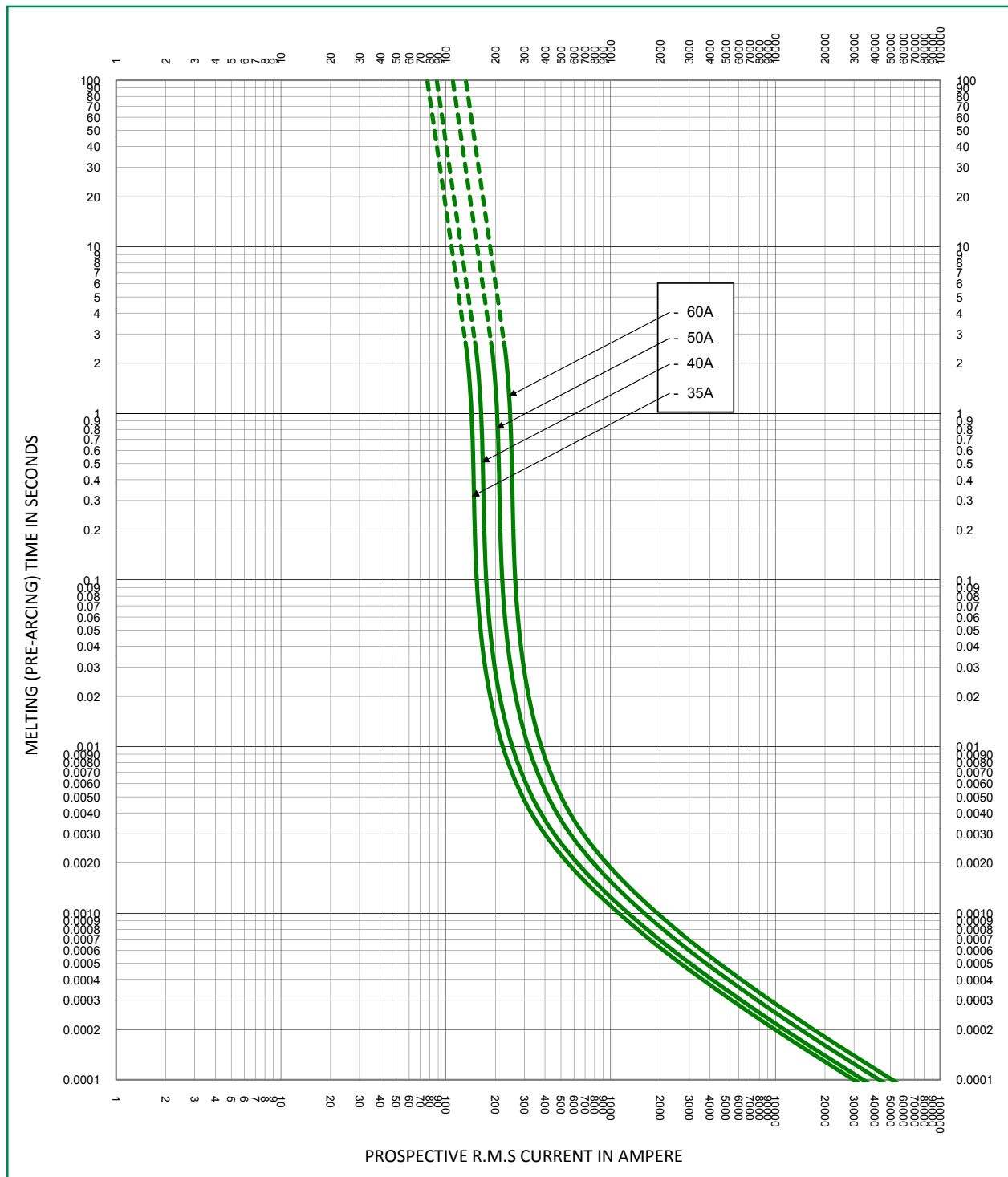

**Time Current Curve**  
**L70QS Series**

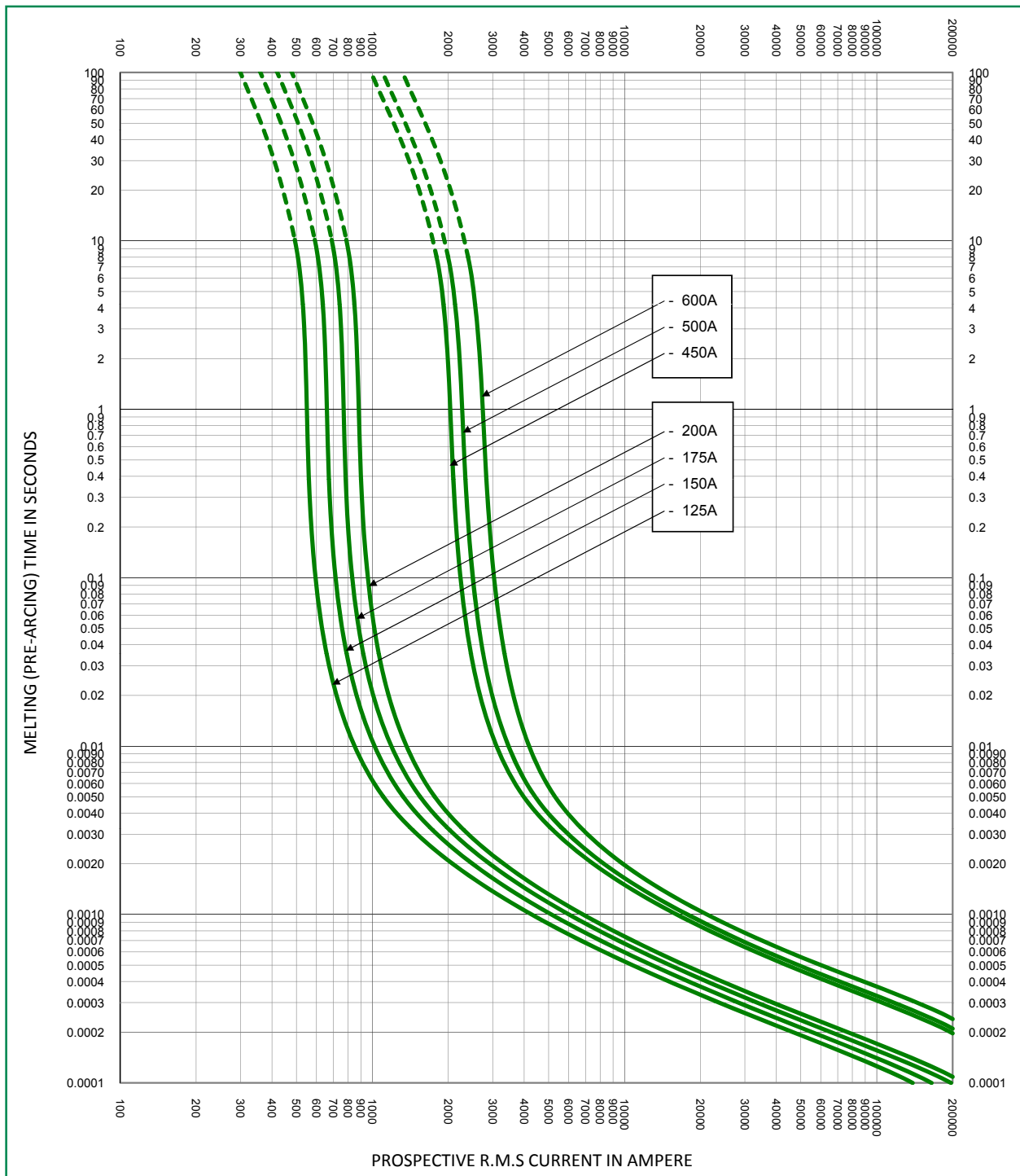

\* Dc minimum breaking capacity = 6 x In (125-200 A only)

**Time Current Curve**

L70QS Series

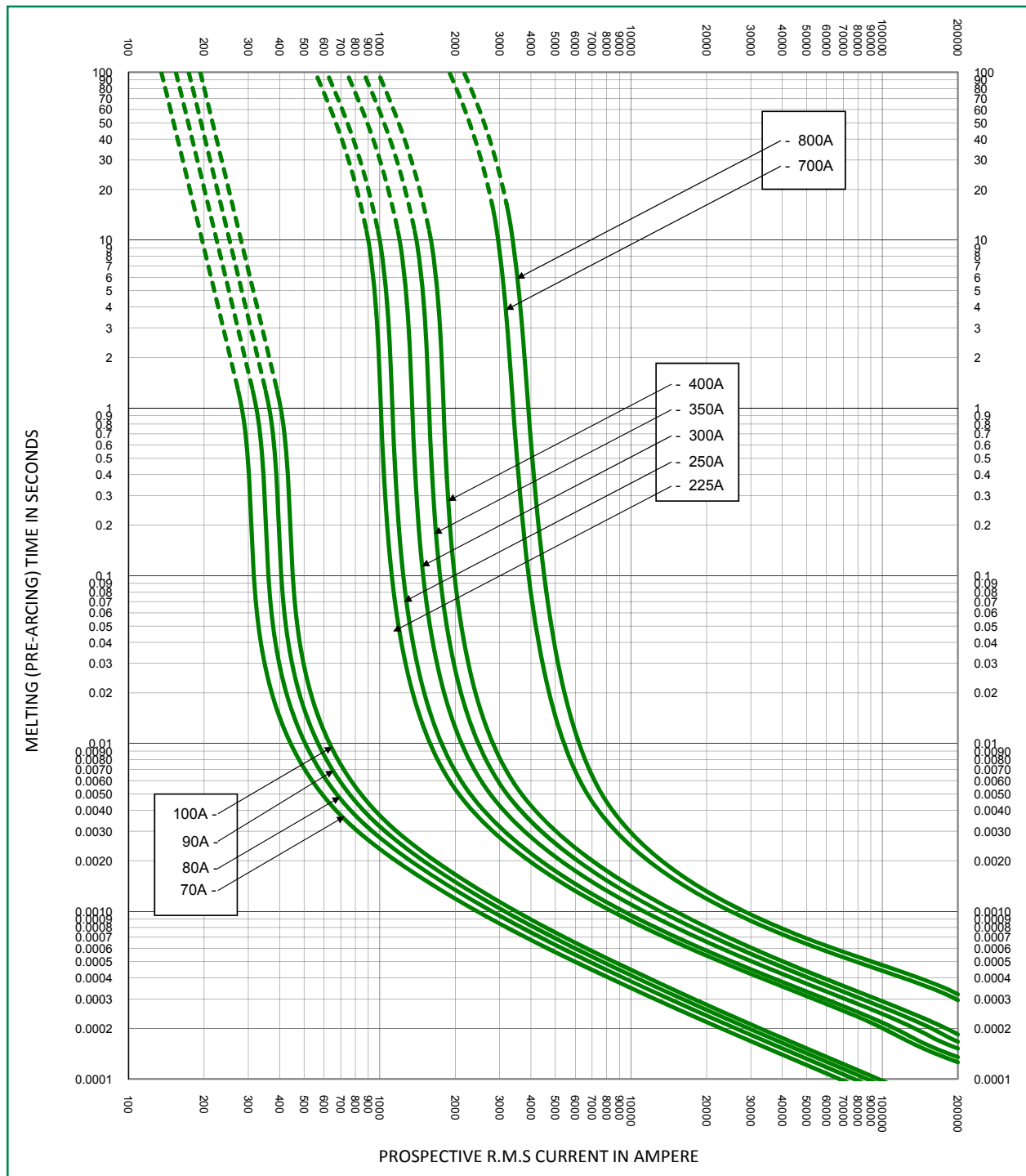

**Peak Let-Thru Curve**

L70QS Series

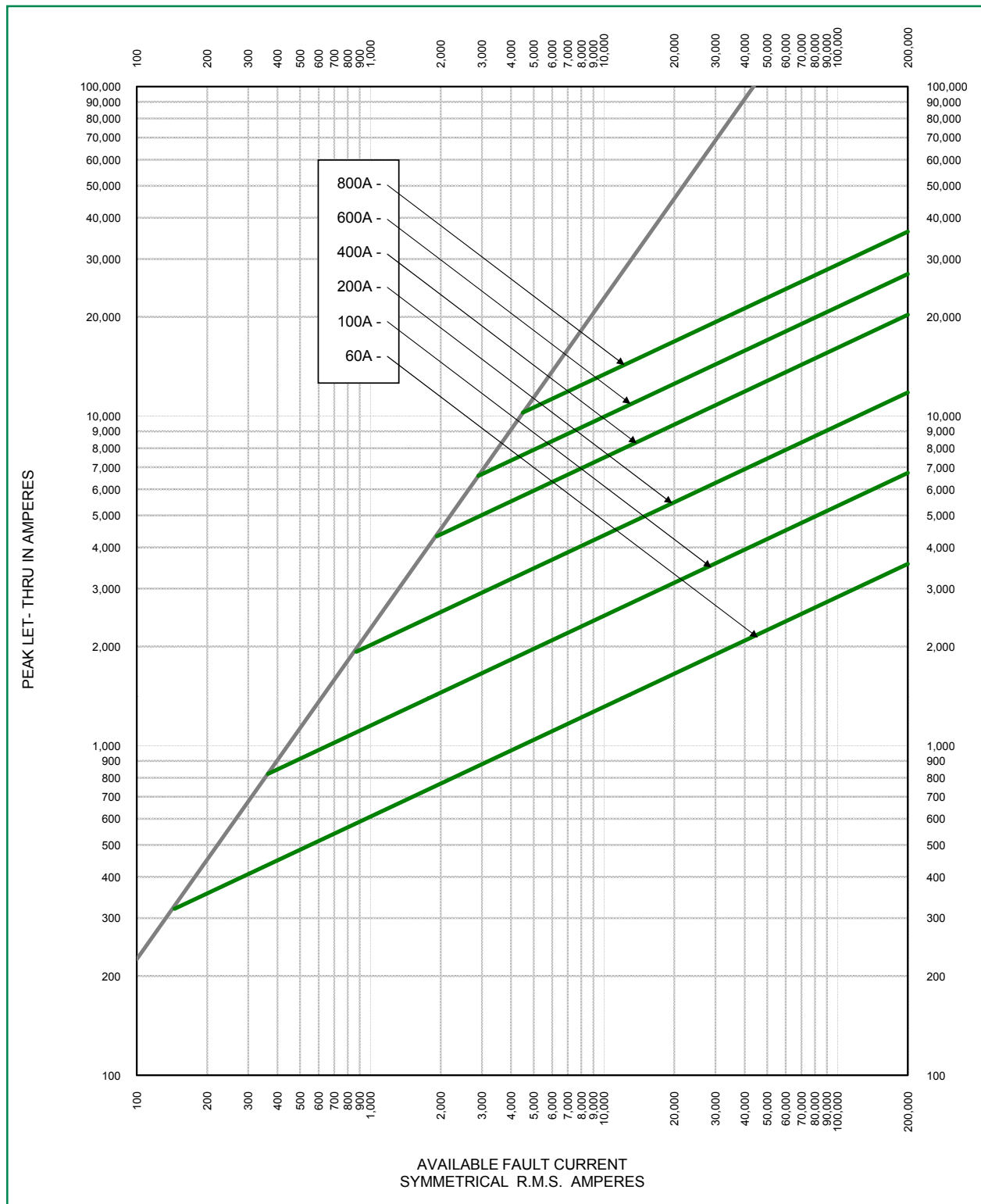

**POWR-SPEED® Fuse**  
**L70QS SERIES HIGH-SPEED ROUND BODY**

**Temperature De-rating Curve** (temperature of air immediately surrounding fuse)  
 L70QS Series

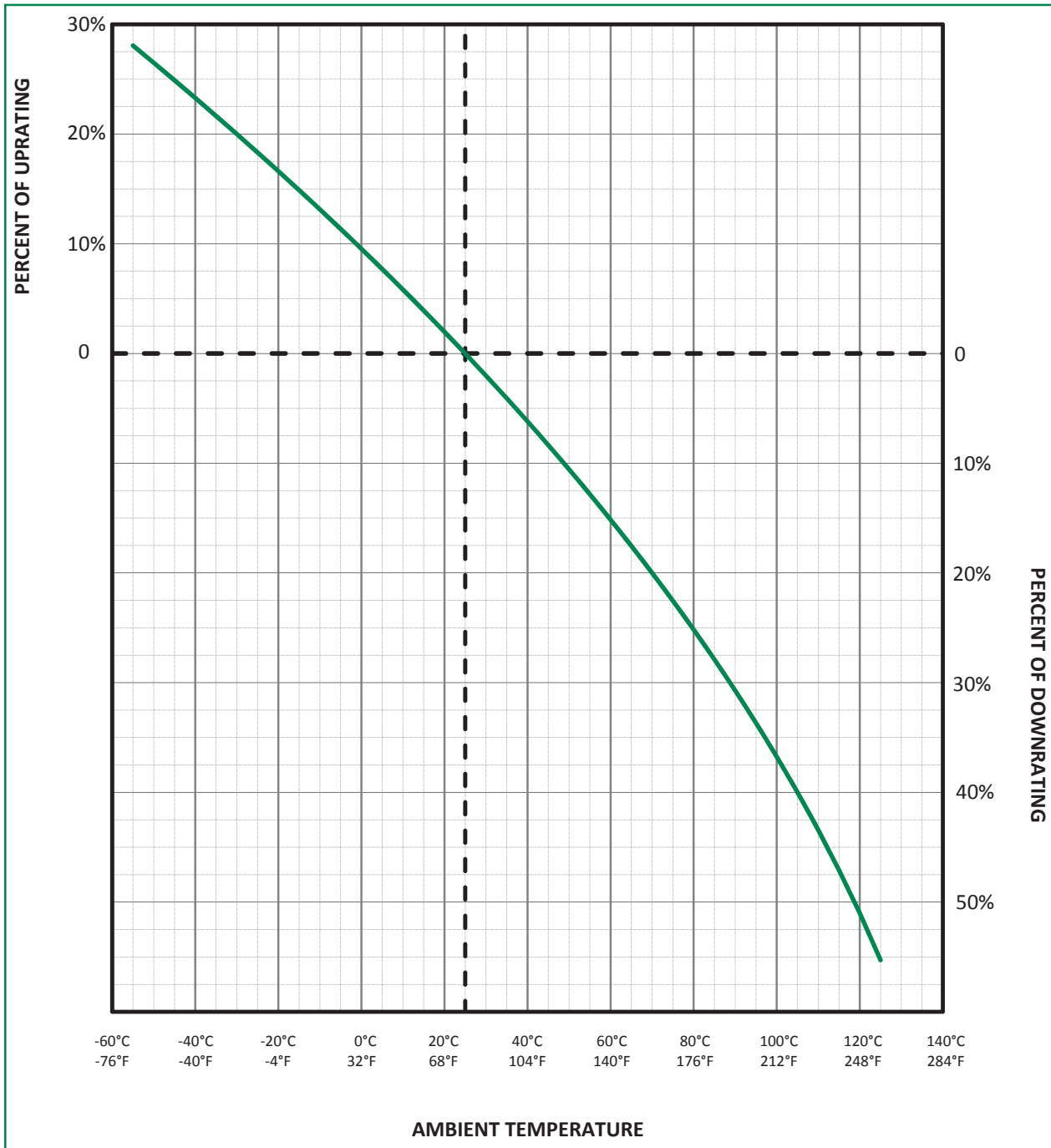



**Total Clearing I<sup>2</sup>t Correction Factor Curve**  
L70QS Series

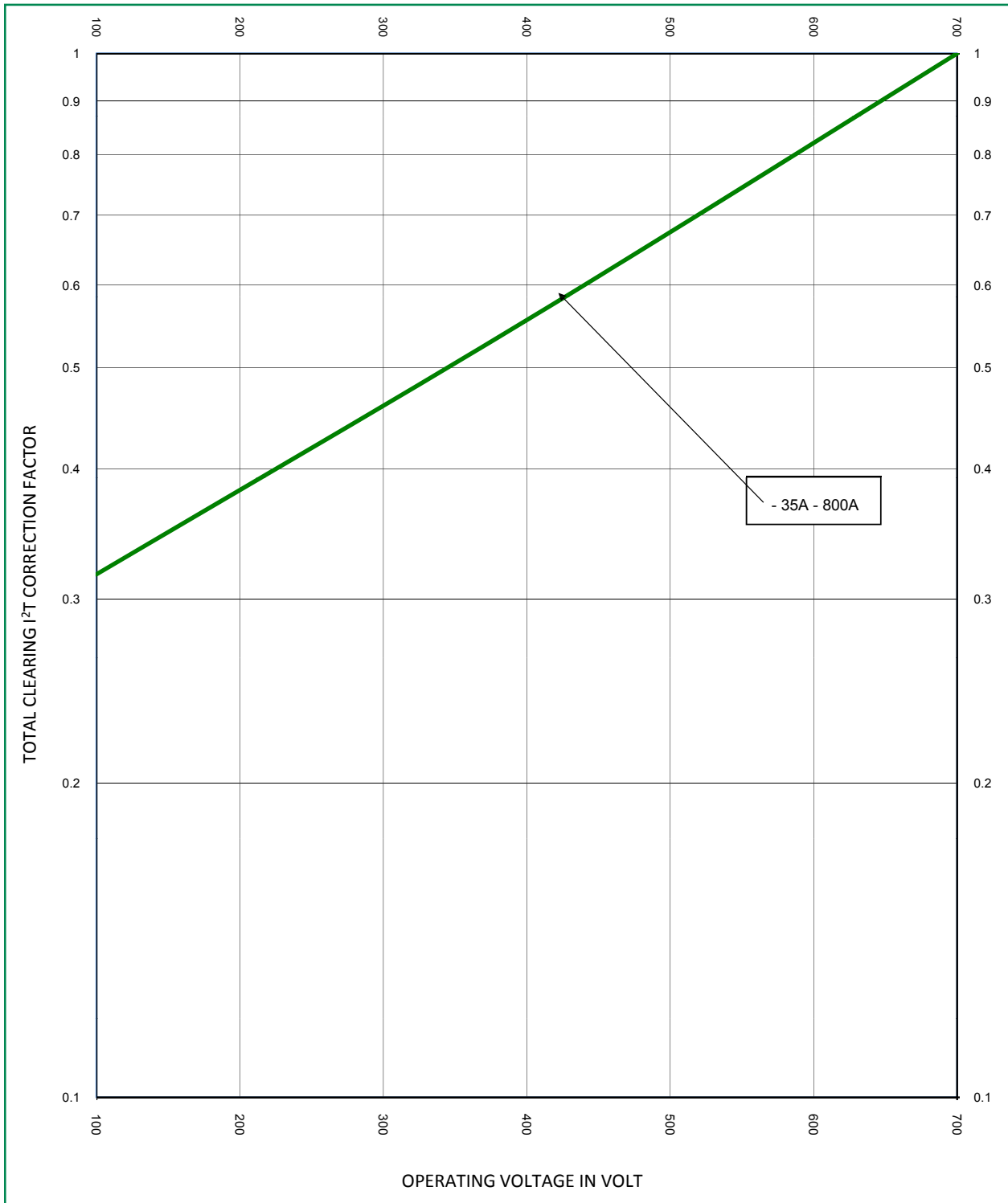

**Watts Loss Correction Factor Curve**

L70QS Series

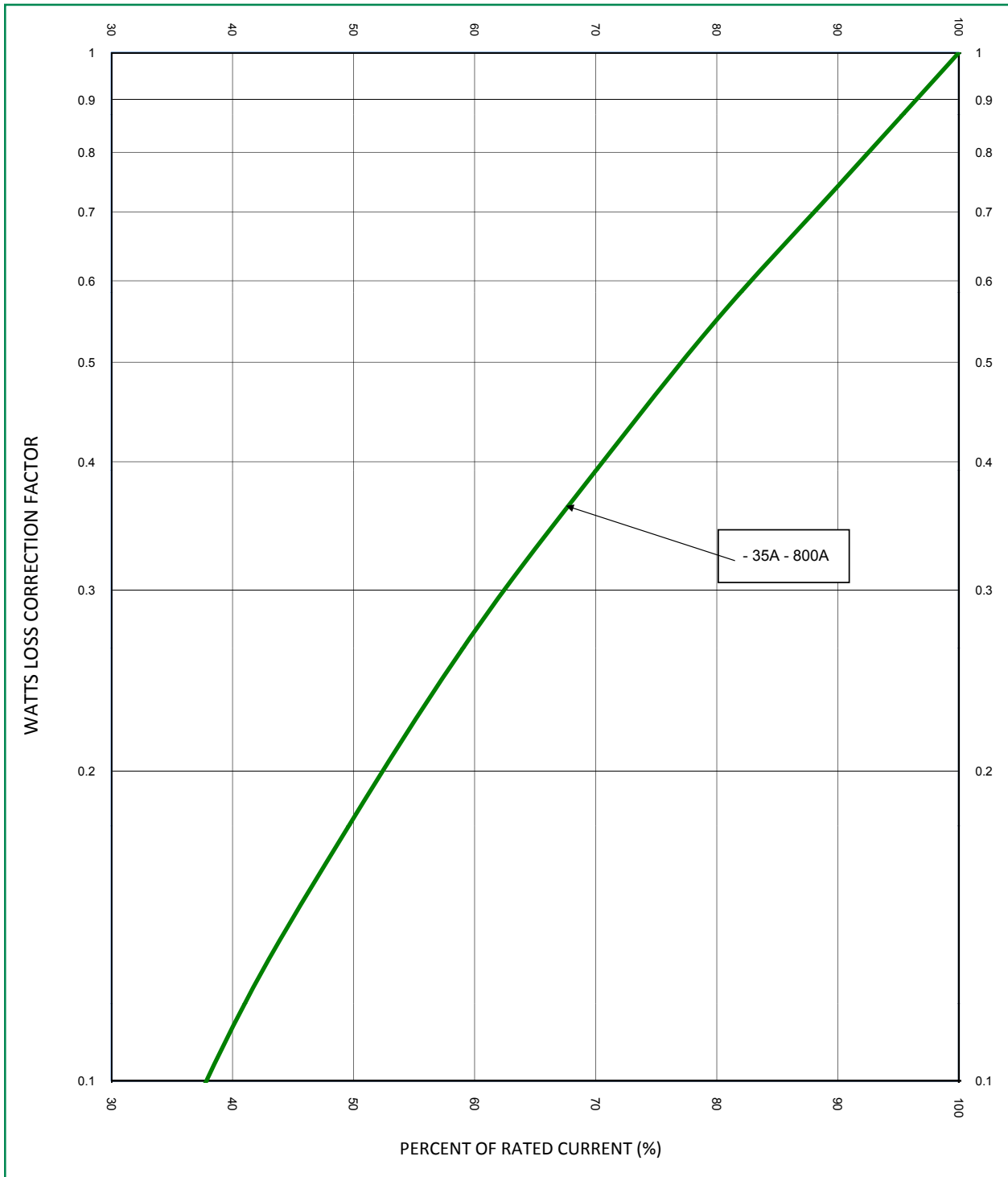

**Peak Arc Voltage Curve**

L70QS Series

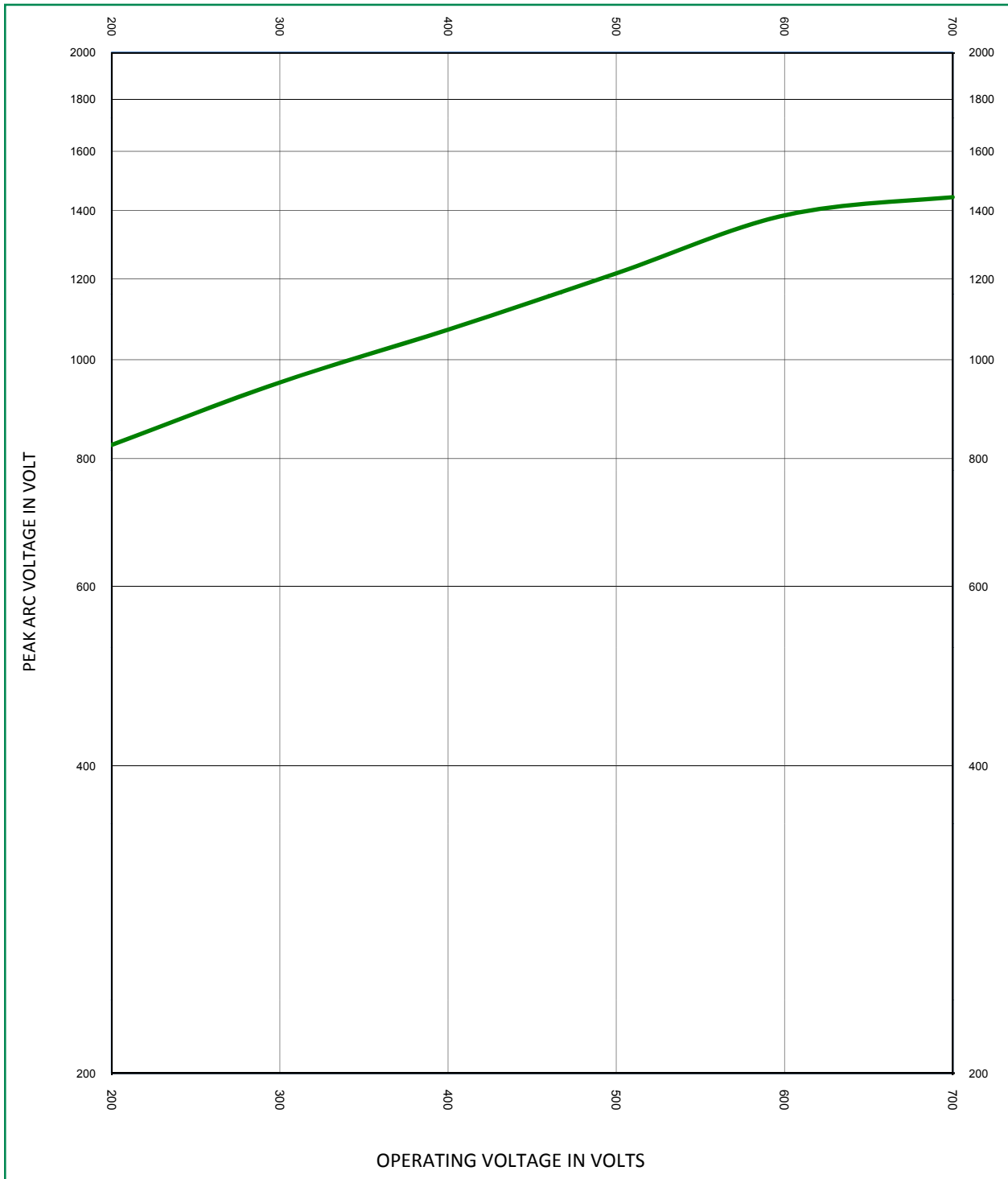

**Disclaimer Notice** - Littelfuse products are not designed for, and shall not be used for, any purpose (including, without limitation, automotive, military, aerospace, medical, life-saving, life-sustaining or nuclear facility applications, devices intended for surgical implant into the body, or any other application in which the failure or lack of desired operation of the product may result in personal injury, death, or property damage) other than those expressly set forth in applicable Littelfuse product documentation. Warranties granted by Littelfuse shall be deemed void for products used for any purpose not expressly set forth in applicable Littelfuse documentation. Littelfuse shall not be liable for any claims or damages arising out of products used in applications not expressly intended by Littelfuse as set forth in applicable Littelfuse documentation. The sale and use of Littelfuse products is subject to Littelfuse Terms and Conditions of Sale, unless otherwise agreed by Littelfuse.

[Littelfuse.com/Product-Disclaimer](http://Littelfuse.com/Product-Disclaimer)

单击下面可查看定价，库存，交付和生命周期等信息

[>>Littelfuse\(美国力特\)](#)