

# GenX3™ 600V IGBT w/ SiC Anti-Parallel Diode

## IXGR60N60C3C1

(Electrically Isolated Back Surface)

High Speed PT IGBT for 40-100kHz Switching

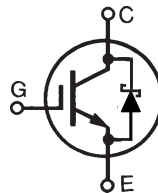

$$V_{CES} = 600V$$

$$I_{C110} = 30A$$

$$V_{CE(sat)} \leq 2.5V$$

$$t_{fi(typ)} = 50ns$$

Symbol	Test Conditions	Maximum Ratings	
$V_{CES}$	$T_J = 25^\circ C$ to $150^\circ C$	600	V
$V_{CGR}$	$T_J = 25^\circ C$ to $150^\circ C$ , $R_{GE} = 1M\Omega$	600	V
$V_{GES}$	Continuous	$\pm 20$	V
$V_{GEM}$	Transient	$\pm 30$	V
$I_{C25}$	$T_C = 25^\circ C$ (Limited by leads)	75	A
$I_{C110}$	$T_C = 110^\circ C$	30	A
$I_{F110}$	$T_C = 110^\circ C$	13	A
$I_{CM}$	$T_C = 25^\circ C$ , 1ms	260	A
$I_A$	$T_C = 25^\circ C$	40	A
$E_{AS}$	$T_C = 25^\circ C$	400	mJ
<b>SSOA</b> <b>(RBSOA)</b>	$V_{GE} = 15V$ , $T_{VJ} = 125^\circ C$ , $R_G = 3\Omega$ Clamped Inductive Load	$I_{CM} = 125$ @ $V_{CE} \leq V_{CES}$	A
$P_c$	$T_C = 25^\circ C$	170	W
$T_J$		-55 ... +150	$^\circ C$
$T_{JM}$		150	$^\circ C$
$T_{stg}$		-55 ... +150	$^\circ C$
$V_{ISOL}$	50/60 Hz, RMS, $t = 1$ minute $I_{ISOL} < 1mA$ $t = 10$ s	2500 3000	V~ V~
$F_c$	Mounting Force	20..120/4.5..27	N/lb
$T_L$	Maximum Lead Temperature for Soldering	300	$^\circ C$
$T_{SOLD}$	1.6mm (0.062 in.) from Case for 10s	260	$^\circ C$
<b>Weight</b>		5	g

### ISOPLUS247™

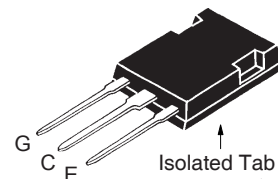

G = Gate      C = Collector  
E = Emitter

### Features

- Silicon Chip on Direct-Copper Bond (DCB) Substrate
- Optimized for Low Switching Losses
- Square RBSOA
- Isolated Mounting Surface
- Anti-Parallel Ultra Fast Diode
- High Speed Silicon Carbide Schottky Co-Pack Diode
- No Reverse Recovery
- 2500V Electrical Isolation
- Avalanche Rated

### Advantages

- High Power Density
- Low Gate Drive Requirement

### Applications

- High Frequency Power Inverters
- UPS
- Motor Drives
- SMPS
- PFC Circuits
- Battery Chargers
- Welding Machines
- Lamp Ballasts

Symbol	Test Conditions ( $T_J = 25^\circ C$ , Unless Otherwise Specified)	Characteristic Values		
		Min.	Typ.	Max.
$V_{GE(th)}$	$I_C = 250\mu A$ , $V_{CE} = V_{GE}$	3.0		5.5 V
$I_{CES}$	$V_{CE} = V_{CES}$ , $V_{GE} = 0V$ $T_J = 125^\circ C$			50 $\mu A$ 1 mA
$I_{GES}$	$V_{CE} = 0V$ , $V_{GE} = \pm 20V$			$\pm 100$ nA
$V_{CE(sat)}$	$I_C = 40A$ , $V_{GE} = 15V$ , Note 1 $T_J = 125^\circ C$	2.2 1.7		2.5 V V

Symbol	Test Conditions ( $T_J = 25^\circ\text{C}$ , Unless Otherwise Specified)	Characteristic Values		
		Min.	Typ.	Max.
$g_{fs}$	$I_C = 40\text{A}$ , $V_{CE} = 10\text{V}$ , Note 1	23	38	S
$C_{ies}$	$V_{CE} = 25\text{V}$ , $V_{GE} = 0\text{V}$ , $f = 1\text{MHz}$		2810	pF
$C_{oes}$			210	pF
$C_{res}$			80	pF
$Q_g$	$I_C = 50\text{A}$ , $V_{GE} = 15\text{V}$ , $V_{CE} = 0.5 \cdot V_{CES}$		115	nC
$Q_{ge}$			43	nC
$Q_{gc}$			22	nC
$t_{d(on)}$	<b>Inductive Load, <math>T_J = 25^\circ\text{C}</math></b> $I_C = 40\text{A}$ , $V_{GE} = 15\text{V}$ $V_{CE} = 480\text{V}$ , $R_G = 3\Omega$ Note 2		24	ns
$t_{ri}$			40	ns
$E_{on}$			0.83	mJ
$t_{d(off)}$			70	110 ns
$t_{fi}$			50	ns
$E_{off}$			0.45	0.80 mJ
$t_{d(on)}$	<b>Inductive Load, <math>T_J = 125^\circ\text{C}</math></b> $I_C = 40\text{A}$ , $V_{GE} = 15\text{V}$ $V_{CE} = 480\text{V}$ , $R_G = 3\Omega$ Note 2		23	ns
$t_{ri}$			39	ns
$E_{on}$			0.78	mJ
$t_{d(off)}$			112	ns
$t_{fi}$			86	ns
$E_{off}$			0.80	mJ
$R_{thJC}$			0.73	$^\circ\text{C/W}$
$R_{thCS}$		0.15		$^\circ\text{C/W}$

### ISOPLUS247 (IXGR) Outline

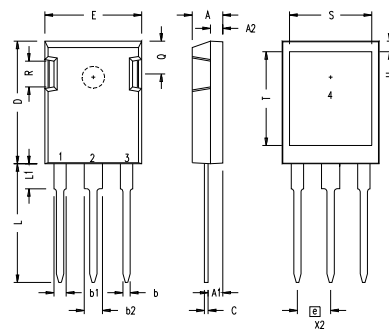

SYM	INCHES		MILLIMETERS	
	MIN	MAX	MIN	MAX
A	.190	.205	4.83	5.21
A1	.090	.100	2.29	2.54
A2	.075	.085	1.91	2.16
b	.045	.055	1.14	1.40
b1	.075	.084	1.91	2.13
b2	.115	.123	2.92	3.12
C	.024	.031	0.61	0.80
D	.819	.840	20.80	21.34
E	.620	.635	15.75	16.13
e	.215 BSC		5.45 BSC	
L	.780	.800	19.81	20.32
L1	.150	.170	3.81	4.32
Q	.220	.244	5.59	6.20
R	.170	.190	4.32	4.83
S	.520	.540	13.21	13.72
T	.620	.640	15.75	16.26
U	.065	.080	1.65	2.03

- 1 - GATE
- 2 - DRAIN (COLLECTOR)
- 3 - SOURCE (EMITTER)
- 4 - NO CONNECTION

NOTE: This drawing will meet all dimensions requirement of JEDEC outline TO-247AD except screw hole.

### Reverse Diode (SiC)

Symbol	Test Conditions ( $T_J = 25^\circ\text{C}$ , Unless Otherwise Specified)	Characteristic Values		
		Min.	Typ.	Max.
$V_F$	$I_F = 20\text{A}$ , $V_{GE} = 0\text{V}$ , Note 1 $T_J = 125^\circ\text{C}$		1.65	2.10 V
			1.80	V
$R_{thJC}$				1.75 $^\circ\text{C/W}$

### Notes:

1. Pulse test,  $t \leq 300\mu\text{s}$ , duty cycle,  $d \leq 2\%$ .
2. Switching times & energy losses may increase for higher  $V_{CE}$  (Clamp),  $T_J$  or  $R_G$ .

IXYS Reserves the Right to Change Limits, Test Conditions, and Dimensions.

IXYS MOSFETs and IGBTs are covered by one or more of the following U.S. patents:	4,835,592	4,931,844	5,049,961	5,237,481	6,162,665	6,404,065 B1	6,683,344	6,727,585	7,005,734 B2	7,157,338B2
	4,850,072	5,017,508	5,063,307	5,381,025	6,259,123 B1	6,534,343	6,710,405 B2	6,759,692	7,063,975 B2	
	4,881,106	5,034,796	5,187,117	5,486,715	6,306,728 B1	6,583,505	6,710,463	6,771,478 B2	7,071,537	

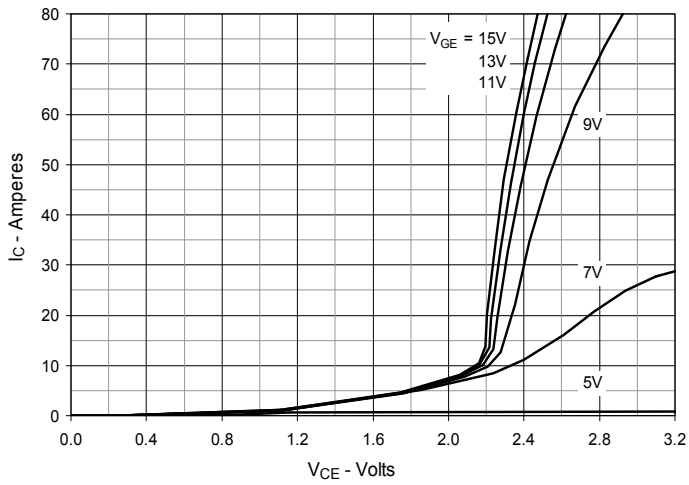
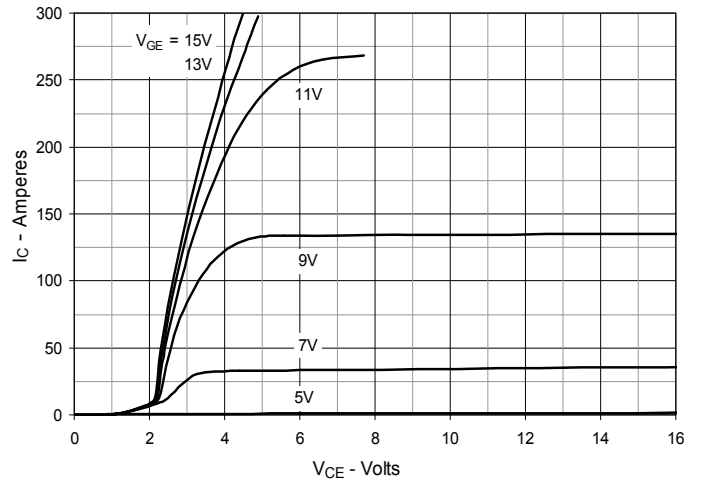
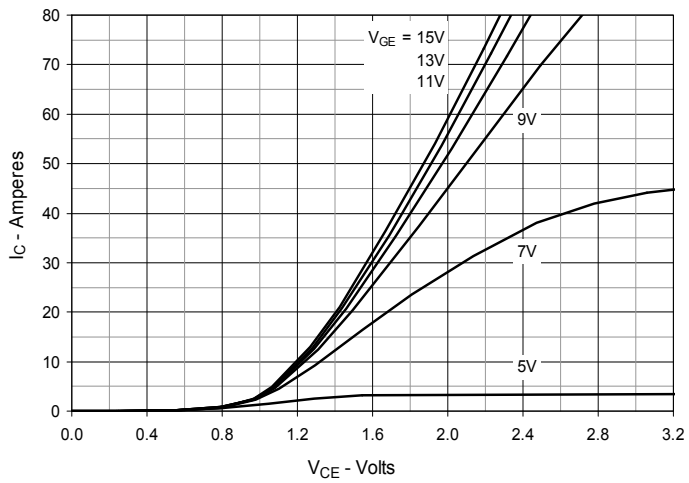
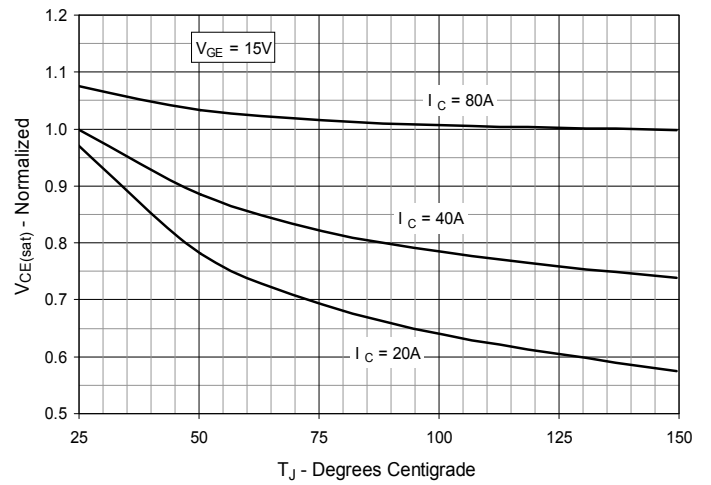
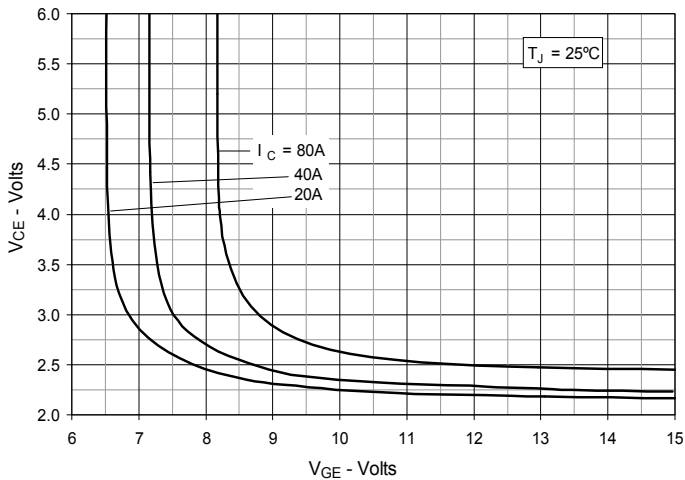
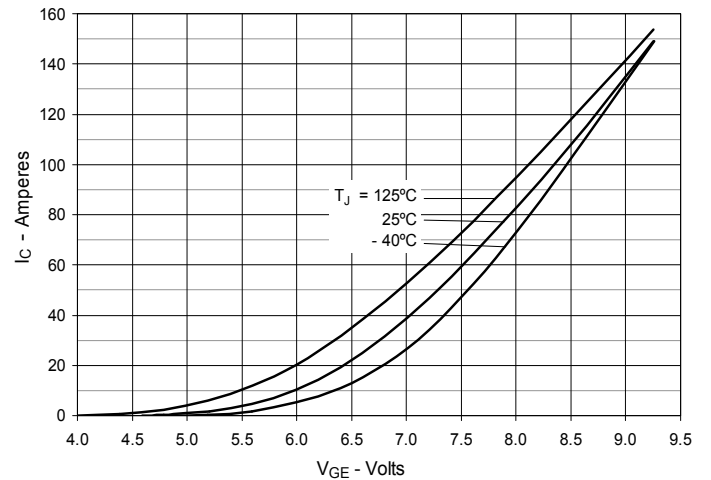
**Fig. 1. Output Characteristics @  $T_J = 25^\circ\text{C}$** 

**Fig. 2. Extended Output Characteristics @  $T_J = 25^\circ\text{C}$** 

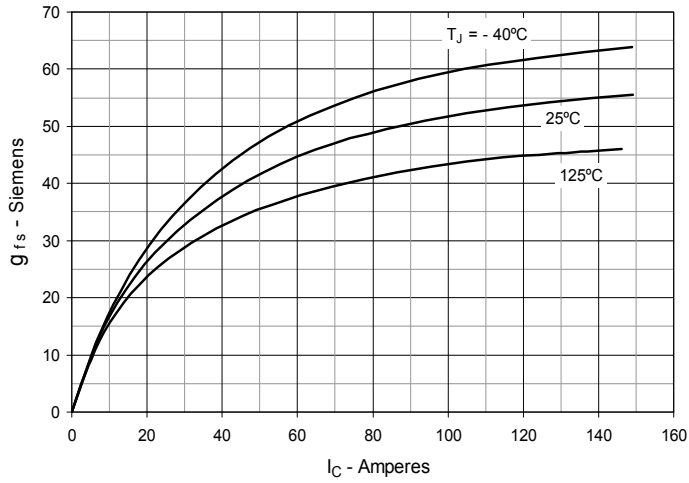
**Fig. 3. Output Characteristics @  $T_J = 125^\circ\text{C}$** 

**Fig. 4. Dependence of  $V_{CE(sat)}$  on Junction Temperature**

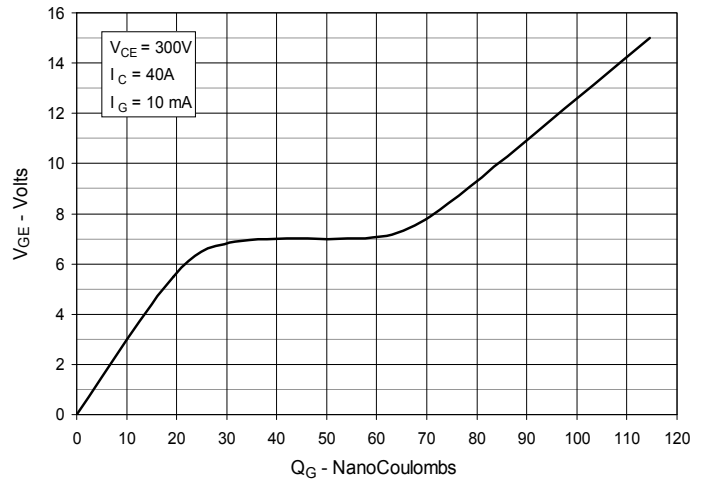
**Fig. 5. Collector-to-Emitter Voltage vs. Gate-to-Emitter Voltage**

**Fig. 6. Input Admittance**

**Fig. 7. Transconductance**



**Fig. 8. Gate Charge**



**Fig. 9. Capacitance**

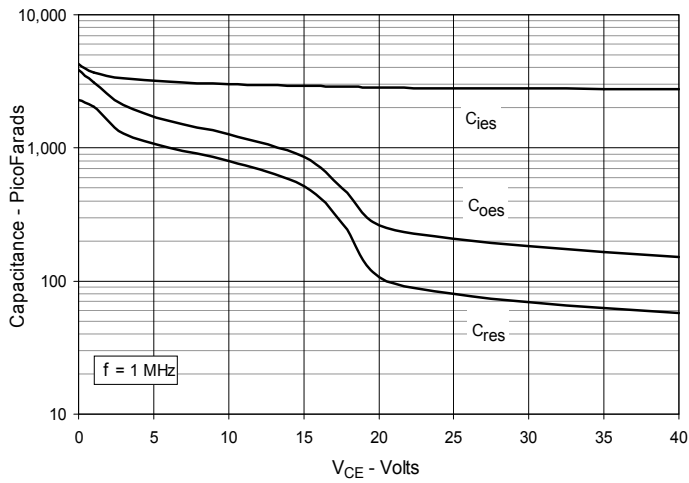

**Fig. 10. Reverse-Bias Safe Operating Area**

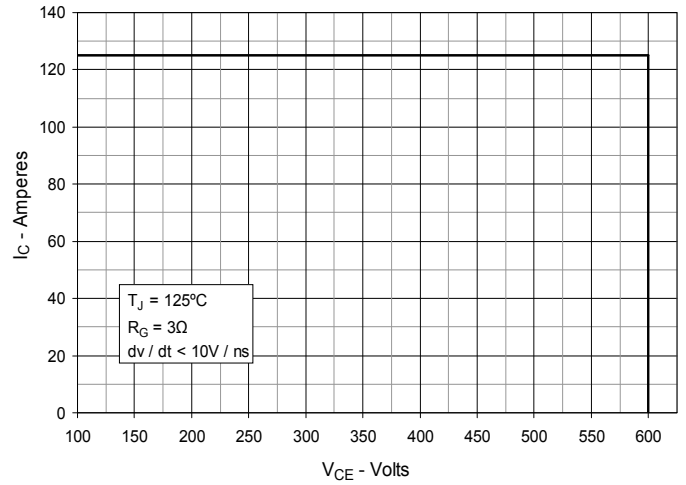

**Fig. 11. Maximum Transient Thermal Impedance**

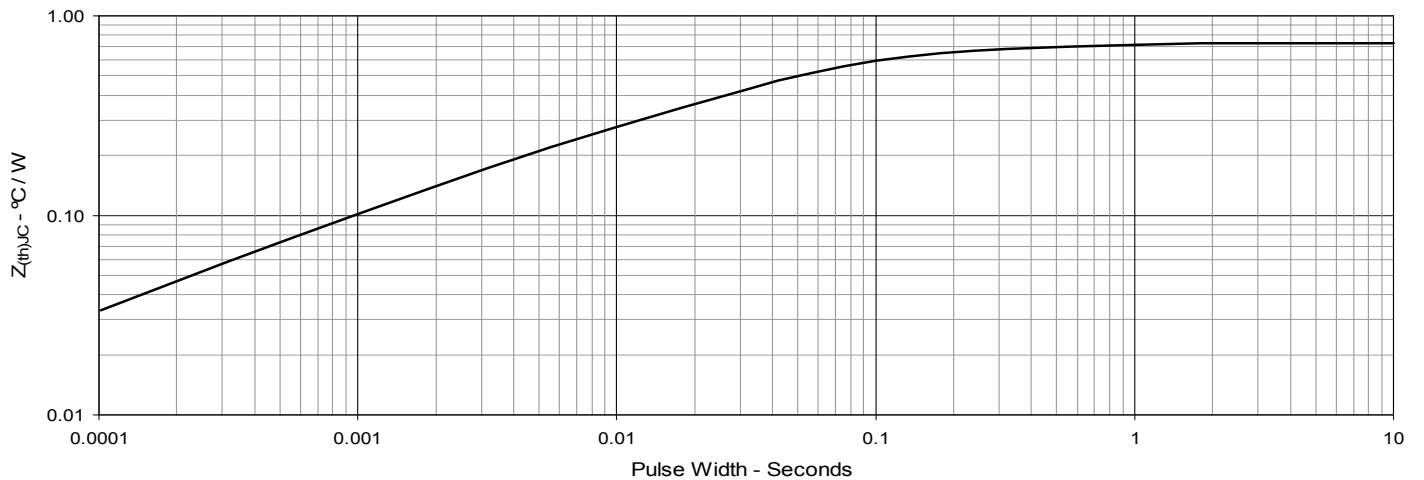

IXYS Reserves the Right to Change Limits, Test Conditions, and Dimensions.

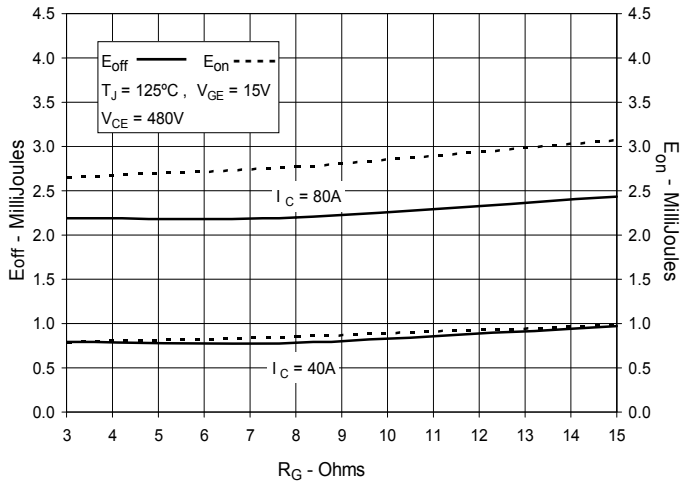
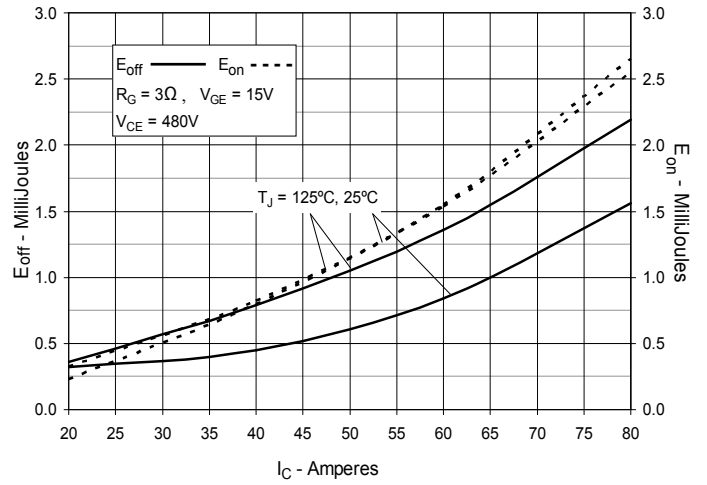
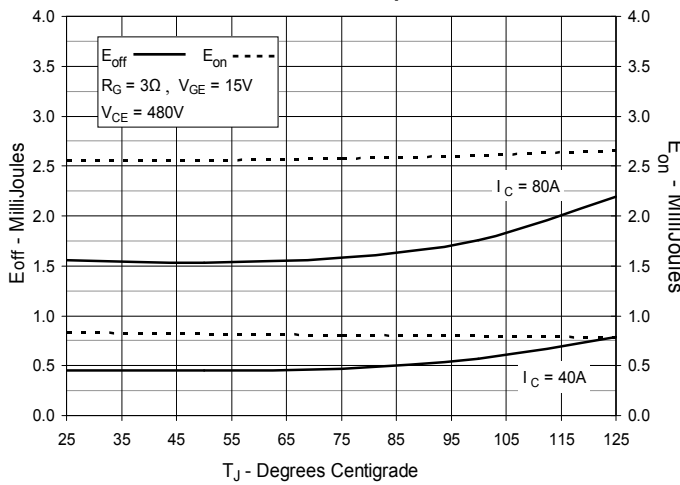
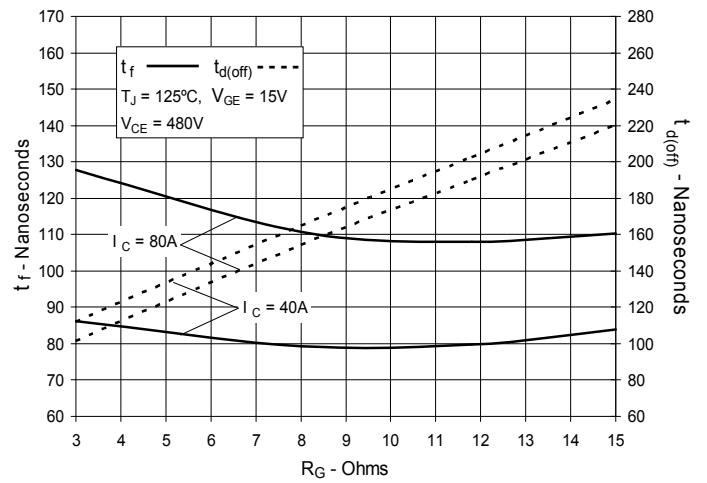
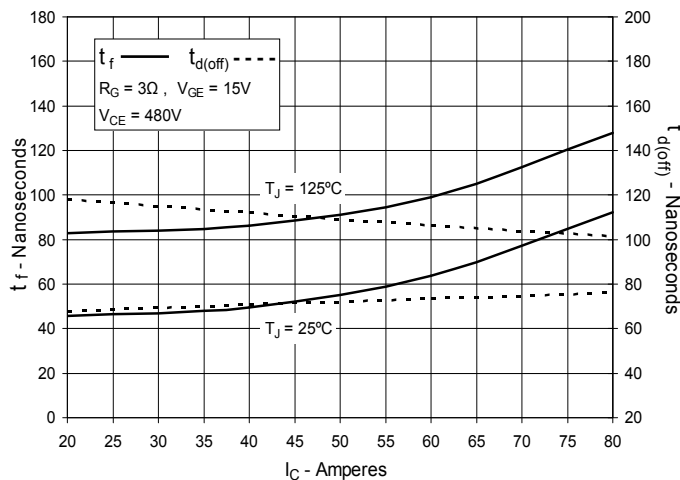
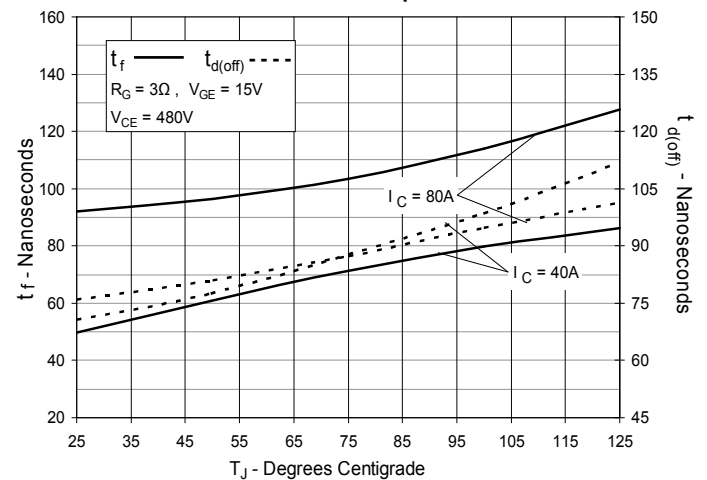
**Fig. 12. Inductive Switching Energy Loss vs. Gate Resistance**

**Fig. 13. Inductive Switching Energy Loss vs. Collector Current**

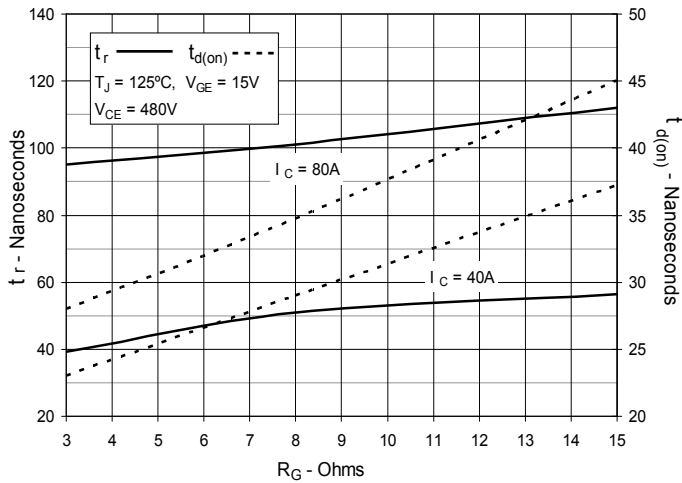
**Fig. 14. Inductive Switching Energy Loss vs. Junction Temperature**

**Fig. 15. Inductive Turn-off Switching Times vs. Gate Resistance**

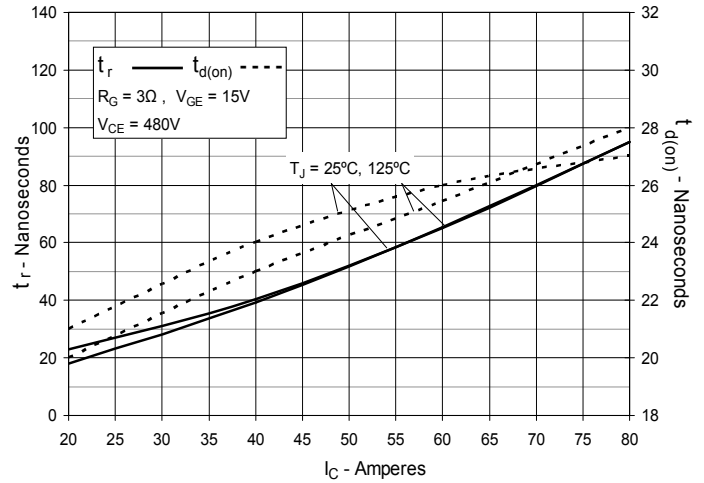
**Fig. 16. Inductive Turn-off Switching Times vs. Collector Current**

**Fig. 17. Inductive Turn-off Switching Times vs. Junction Temperature**

**Fig. 18. Inductive Turn-on Switching Times vs. Gate Resistance**



**Fig. 19. Inductive Turn-on Switching Times vs. Collector Current**



**Fig. 20. Inductive Turn-on Switching Times vs. Junction Temperature**

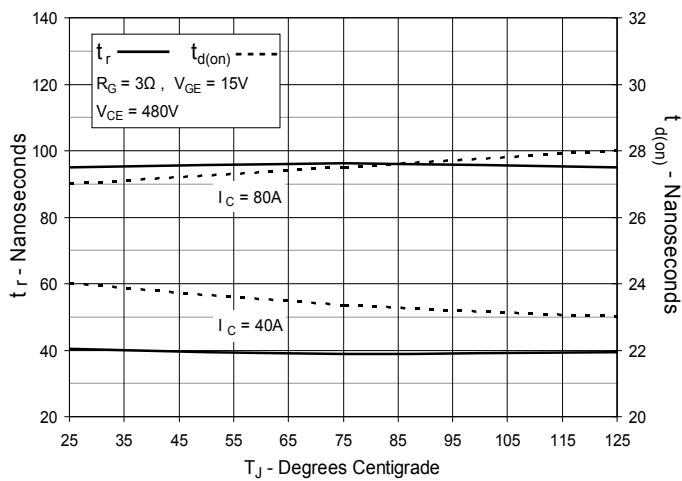

**Fig. 21. Forward Current vs. Forward Voltage**

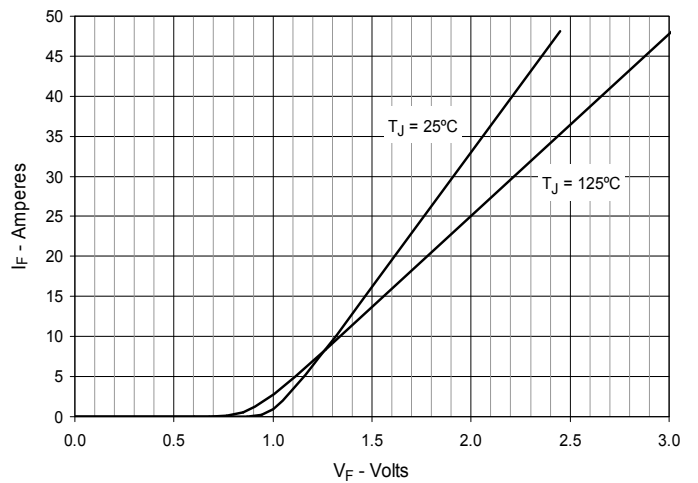

**Fig. 22. Maximum Transient Thermal Impedance for Diodes**

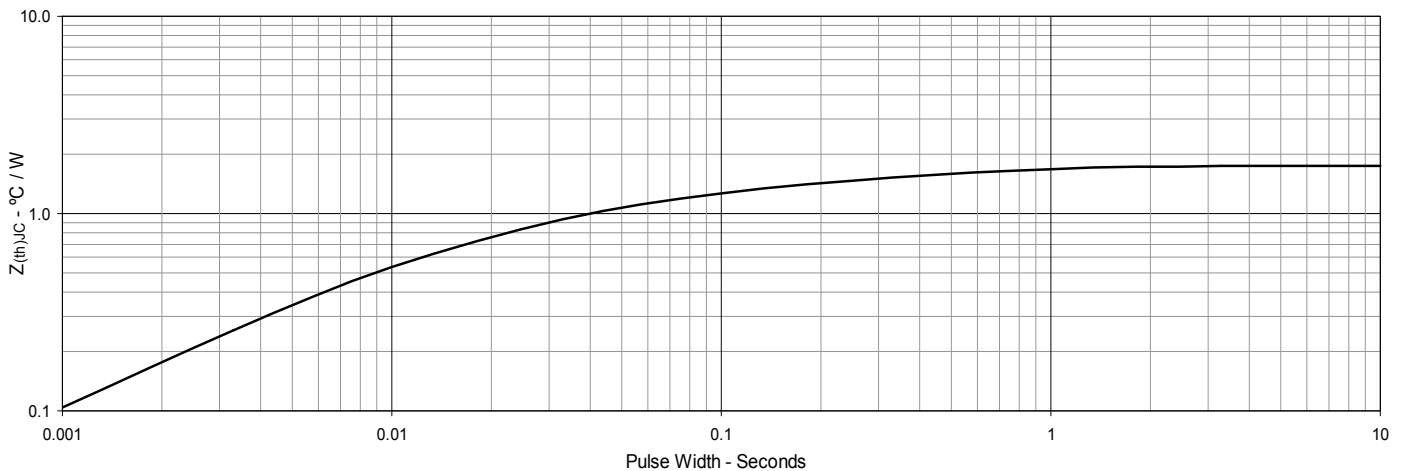

IXYS Reserves the Right to Change Limits, Test Conditions, and Dimensions.



---

Disclaimer Notice - Information furnished is believed to be accurate and reliable. However, users should independently evaluate the suitability of and test each product selected for their own applications. Littelfuse products are not designed for, and may not be used in, all applications. Read complete Disclaimer Notice at [www.littelfuse.com/disclaimer-electronics](http://www.littelfuse.com/disclaimer-electronics).

单击下面可查看定价，库存，交付和生命周期等信息

[>>Littelfuse\(美国力特\)](#)