

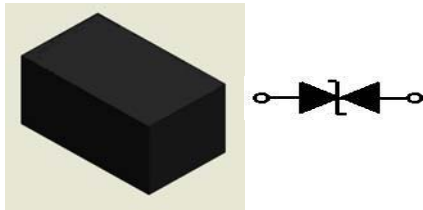

ESDQR36V0B

36V Bi-directional ESD



Features

- Surface mount package.
- Bi-directional ESD protection.
- IEC61000-4-2 ±25kV(Contact), ±25kV(air).
- Ultra small SMD package: 0402.
- Operating voltage: 36V
- Pb free version, RoHS compliant, and Halogen free

Mechanical Characteristics

- Case: DFN1006(0402) standard package
- Terminals: Sn / Au plated, solderable per MIL-STD-750, method 2026
- Marking Code: E6
- Mounting position: Any.
- Weight: 0.001 gram(approx.)
- MSL: Level 1

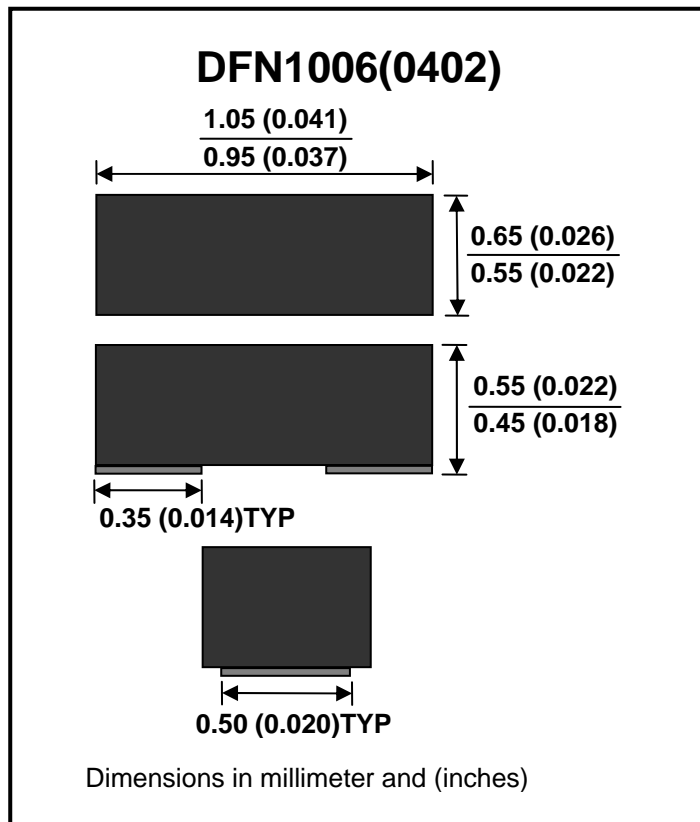

Maximum Rating And Electrical Characteristics (at Ta=25°C unless otherwise noted)

Parameter	Condition	Symbol	Min	Typ	Max	Unit
Peak Pulse Power	tp=8/20 μs (According to IEC61000-4-5)	Ppp		100		W
Maximum Peak Pulse Current	tp=8/20 μs (According to IEC61000-4-5)	Ipp		1.5		A
ESD per IEC 61000-4-2 (Air)		VESD		±25		kV
ESD per IEC 61000-4-2 (Contact)				±25		kV
Operating Junction Temperature		Tj	-40		125	°C
Storage Temperature		Tstg	-55		150	°C
Reverse Stand-Off Voltage		VRWM			36	V
Reverse Breakdown Voltage	It = 1mA	VBR	40			V
Reverse Leakage Current	VRWM = 36V	IR			100	nA
Clamping Voltage	Ipp = 1A , tp = 8/20 μs	Vc			58	V
Junction Capacitance	Between I/O Pin and GND VR=0V , f=1MHz	Cj		10		pF



Typical Characteristics

Fig.1 - 8/20us Peak Pulse Current Waveform Acc. IEC 61000-4-5

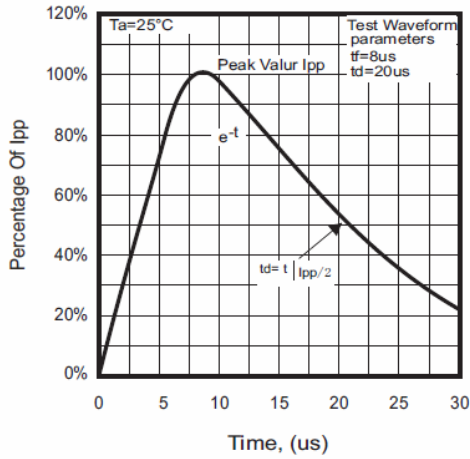

Fig.2 - Power Rating Derating Curve

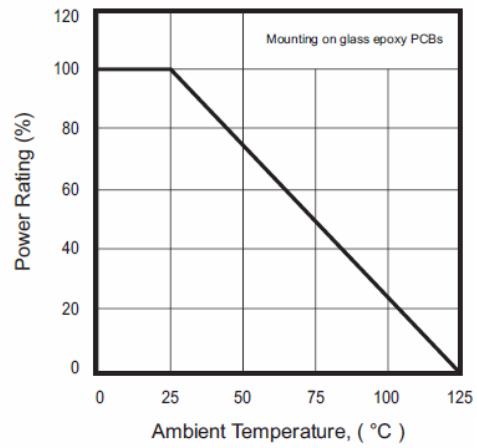

Fig.3 - Typical Clamping Voltage Vs. Peak Pulse Current

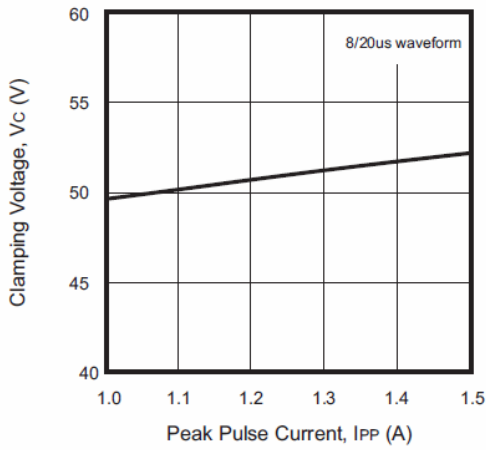
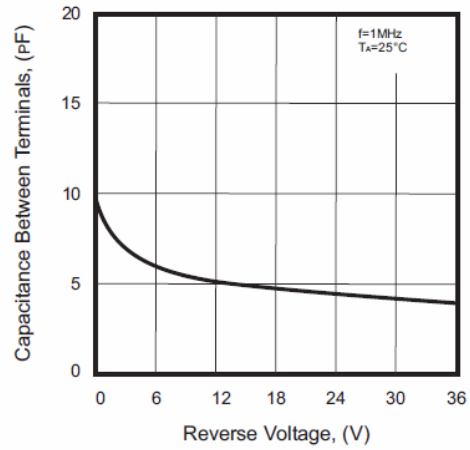

Fig.4 - Typical Capacitance Between Terminals Characteristics





ESD Diode

Packing Specification

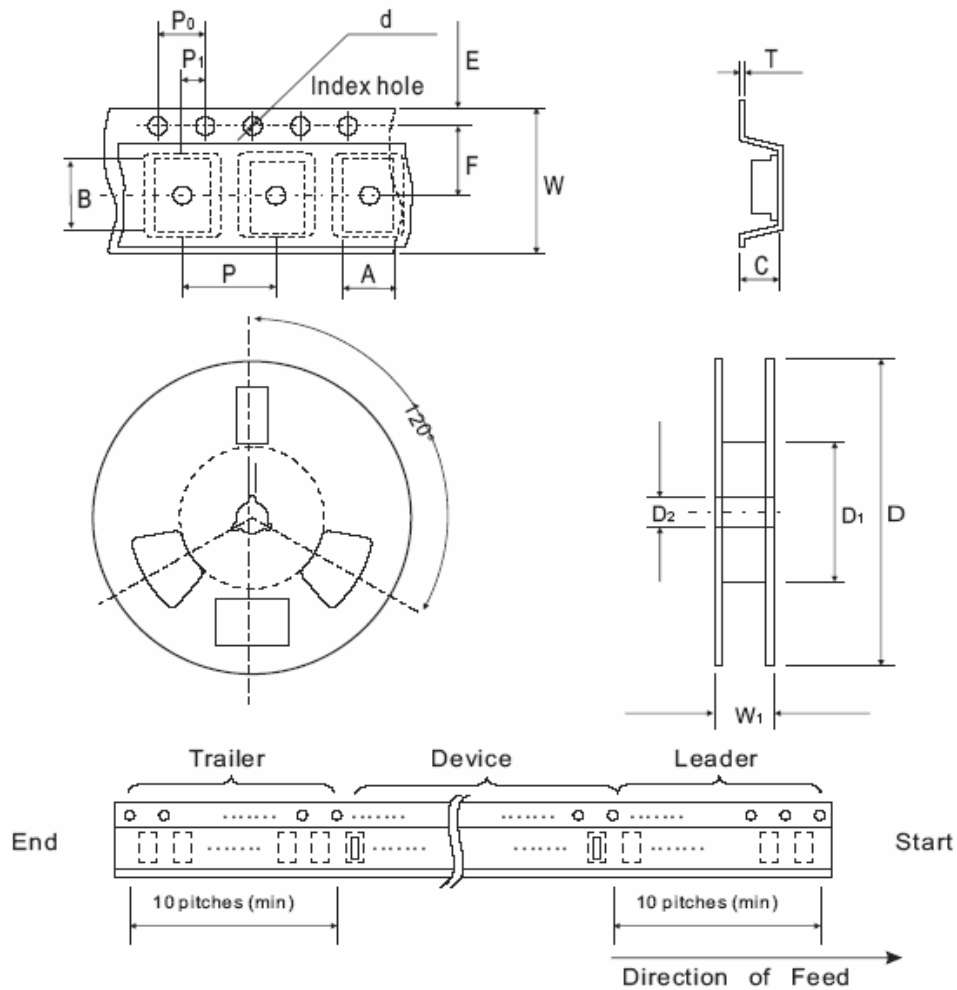

Tape & Reel Dimensions

Package	Unit	A	B	C	d	D
DFN1006	mm	0.67±0.10	1.12±0.10	0.60±0.10	1.50±0.10	178±1
	inch	0.026±0.004	0.044±0.004	0.024±0.004	0.060±0.004	7.008±0.04

Package	Unit	D1	D2	E	F	P
DFN1006	mm	60MIN	13.0±0.20	1.75±0.10	3.5±0.10	4.0±0.10
	inch	2.362MIN	0.512±0.008	0.069±0.004	0.138±0.004	0.157±0.004

Package	Unit	P0	P1	T	W	W1
DFN1006	mm	4.0±0.10	2.0±0.10	0.22±0.03	8.0±0.10	10.5±0.5
	inch	0.157±0.004	0.079±0.004	0.009±0.002	0.315±0.004	0.413±0.02

**Standard Package**

Package	Reel Size	Qty/Reel
DFN1006	7"	5,000 pcs

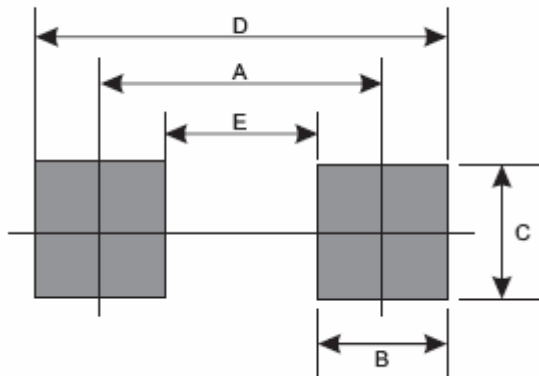
Recommended Soldering Footprint**Reflow Soldering**

Product Size	Dimension/ mm				
	A	B	C	D	E
DFN1006	0.750	0.500	0.700	1.250	0.250
	0.030"	0.020"	0.028"	0.049"	0.010"

Marking Code

Part Number	Marking Code
ESDQR36V0B	E6

Disclaimers

These products are not designed for use in applications where any failure or malfunction may result in personal injury, death or severe property or environmental damage such as medical, military, aircraft, space or life support equipments.

单击下面可查看定价，库存，交付和生命周期等信息

[>>LIZ\(丽智\)](#)