

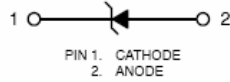

ESD Diode

ESDQR5V0UJ

5V Uni-directional ESD



Features

- Ultra Low Capacitance 0.3 pF
- Low Clamping Voltage
- Stand-off Voltage: 5 V
- Low Leakage
- Response Time is Typically < 1.0 ns
- Pb free version, RoHS compliant, and Halogen free

Mechanical Characteristics

- Case: DFN1006(0402) mold package
- Terminal: Sn/Au plated, solderable per MIL-STD-750, method 2026
- Marking Code: Cathode band & U5
- Mounting position: Any
- Weight: 0.001 gram(approx.).
- MSL: Level 1

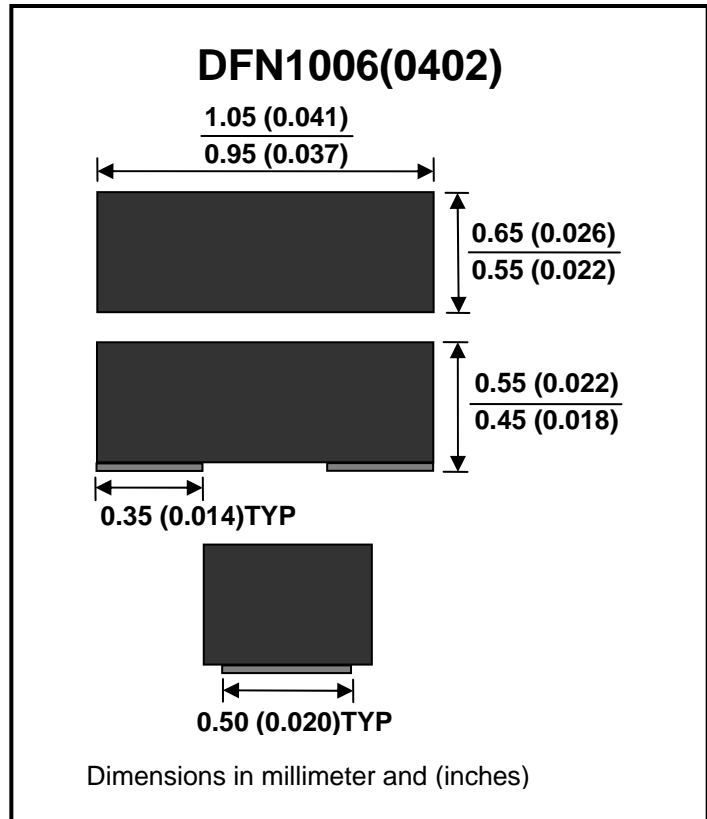

Maximum Rating And Electrical Characteristics (at Ta=25°C unless otherwise noted)

Parameter	Condition	Symbol	Min	Typ	Max	Unit
Peak Pulse Power	tp=8/20us (According to IEC61000-4-5)	Ppp			138	W
Maximum Peak Pulse Current	tp=8/20us (According to IEC61000-4-5)	Ipp			3.6	A
ESD per IEC 61000-4-2 (Air)		VESD			±20	kV
ESD per IEC 61000-4-2 (Contact)					±18	kV
Operating Junction Temperature		Tj			125	°C
Storage Temperature		Tstg	-55		150	°C
Reverse Stand-Off Voltage		VRWM			5	V
Reverse Breakdown Voltage	It = 1mA	VBR	6			V
Reverse Leakage Current	VRWM = 5V	IR			50	nA
Clamping Voltage	Ipp = 1A , tp = 8/20 us	Vc			12	V
	Ipp = 3A , tp = 8/20 us	Vc			20	V
Junction Capacitance	Between I/O Pin and GND VR=0V , f=1MHz	Cj		0.3	0.5	pF



Typical Characteristics

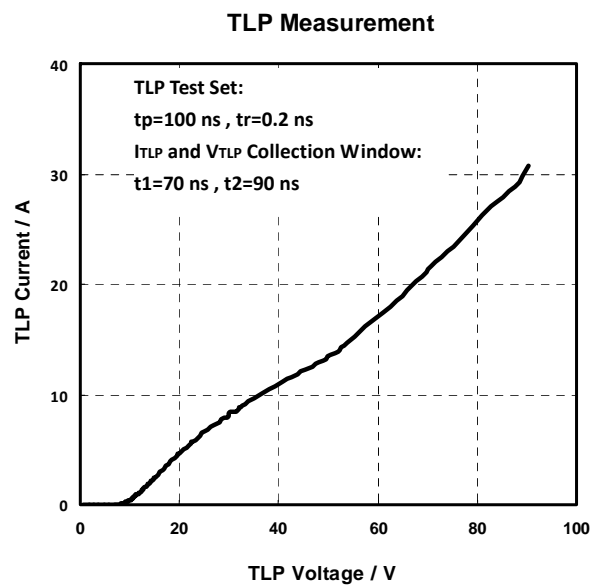
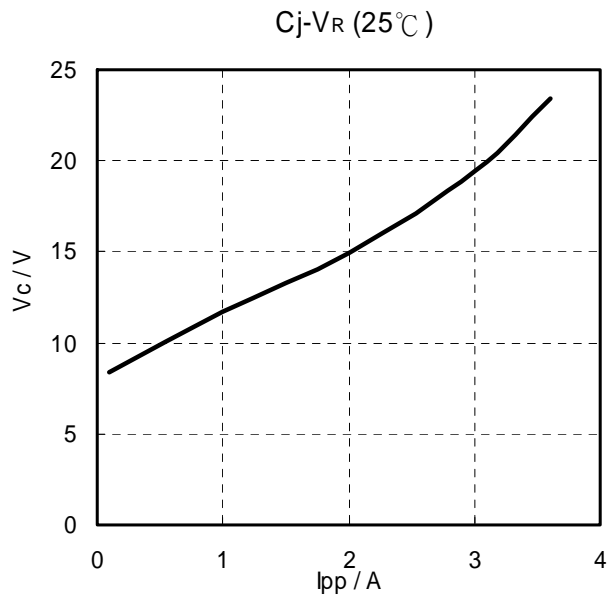
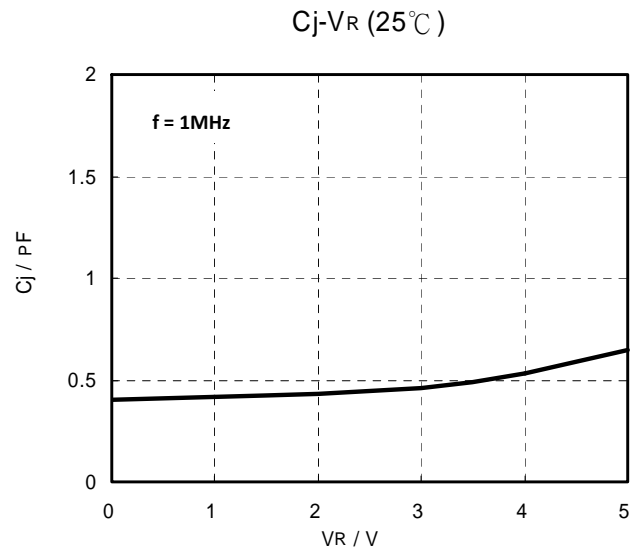
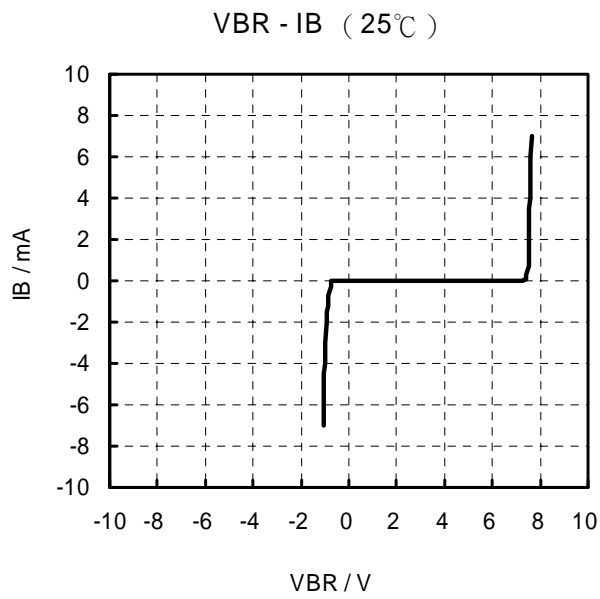



ESD Diode

Packing Specification

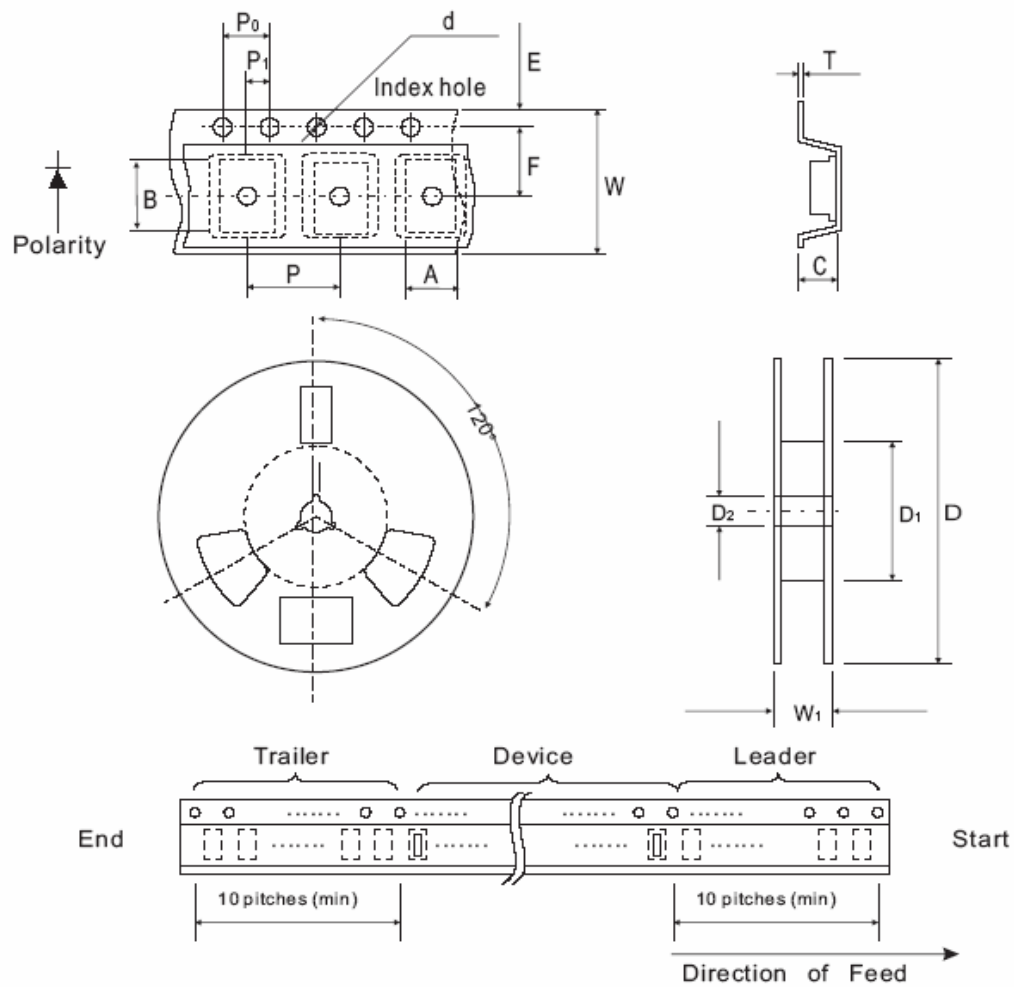

Tape & Reel Dimensions

Package	Unit	A	B	C	d	D
DFN1006	mm	0.67±0.10	1.12±0.10	0.60±0.10	1.50±0.10	178±1
	inch	0.026±0.004	0.044±0.004	0.024±0.004	0.060±0.004	7.008±0.04

Package	Unit	D1	D2	E	F	P
DFN1006	mm	60MIN	13.0±0.20	1.75±0.10	3.5±0.10	4.0±0.10
	inch	2.362MIN	0.512±0.008	0.069±0.004	0.138±0.004	0.157±0.004

Package	Unit	P0	P1	T	W	W1
DFN1006	mm	4.0±0.10	2.0±0.10	0.22±0.03	8.0±0.10	10.5±0.5
	inch	0.157±0.004	0.079±0.004	0.009±0.002	0.315±0.004	0.413±0.02



ESD Diode

Standard Package

Package	Reel Size	Qty/Reel
DFN1006	7"	5,000 pcs

Recommended Soldering Footprint

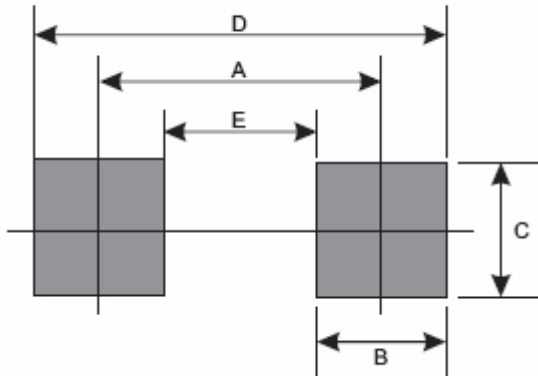

Reflow Soldering

Product Size	Dimension/ mm				
	A	B	C	D	E
DFN1006	0.750	0.500	0.700	1.250	0.250
	0.030"	0.020"	0.028"	0.049"	0.010"

Marking Code

Part Number	Marking Code
ESDQR5V0UJ	U5



Disclaimers

These products are not designed for use in applications where any failure or malfunction may result in personal injury, death or severe property or environmental damage such as medical, military, aircraft, space or life support equipments.

单击下面可查看定价，库存，交付和生命周期等信息

[>>LIZ\(丽智\)](#)