

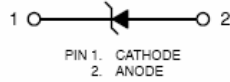

ESD Diode

ESDQR24V0U

24V Uni-directional ESD



Features

- Protects single I/O lines
- Working Voltage: 24V
- Low leakage current
- Low operating and clamping voltages
- Pb free version, RoHS compliant, and Halogen free

Mechanical Characteristics

- Case: DFN1006(0402) standard package
- Terminals: Sn / Au plated, solderable per MIL-STD-750, method 2026
- Marking Code: Cathode band & E4
- Mounting position: Any.
- Weight: 0.001 gram(approx.)
- MSL: Level 1

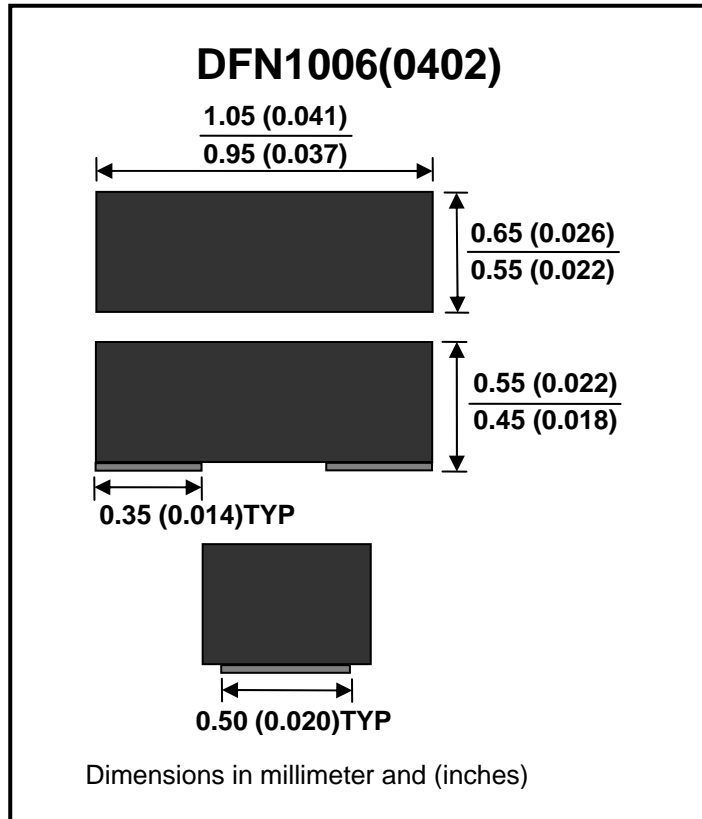

Maximum Rating And Electrical Characteristics (at Ta=25°C unless otherwise noted)

Parameter	Condition	Symbol	Min	Typ	Max	Unit
Peak Pulse Power	tp=8/20us (According to IEC61000-4-5)	PpK		110		W
Maximum Peak Pulse Current	tp=8/20us (According to IEC61000-4-5)	Ipp		3		A
ESD per IEC 61000-4-2 (Air)		VESD		±25		kV
ESD per IEC 61000-4-2 (Contact)				±25		kV
Operating Junction Temperature		Tj	-55		125	°C
Storage Temperature		Tstg	-55		150	°C
Reverse Stand-Off Voltage		VRWM			24	V
Reverse Breakdown Voltage	It = 1mA	VBR		27.6	32	V
Reverse Leakage Current	VRWM = 24V	IR		1	50	nA
Clamping Voltage	Ipp = 1A , tp = 8/20 us	Vc		31	36	V
	Ipp = 3A , tp = 8/20 us			36	42	V
Junction Capacitance	VR=0V , f=1MHz	Cj		25.7	35	pF



Typical Characteristics

Fig.1 - 8/20us Peak Pulse Current Wave Form Acc. IEC 61000-4-5

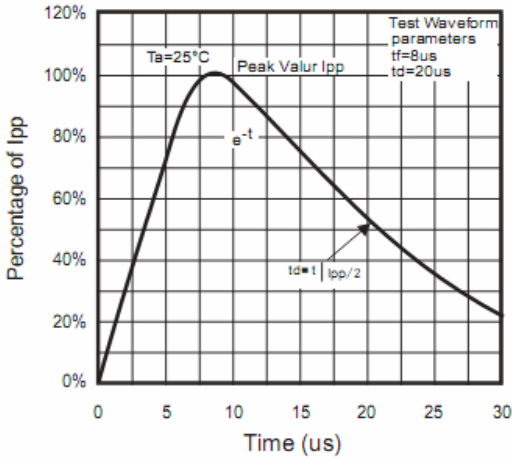

Fig.2 - Power rating derating curve

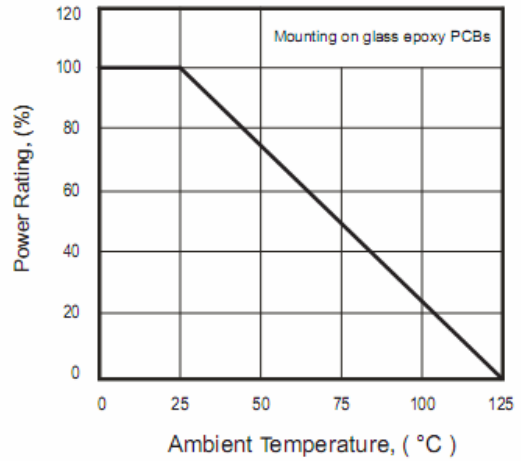

Fig.3 - Clamping Voltage Vs. Peak Pulse Current

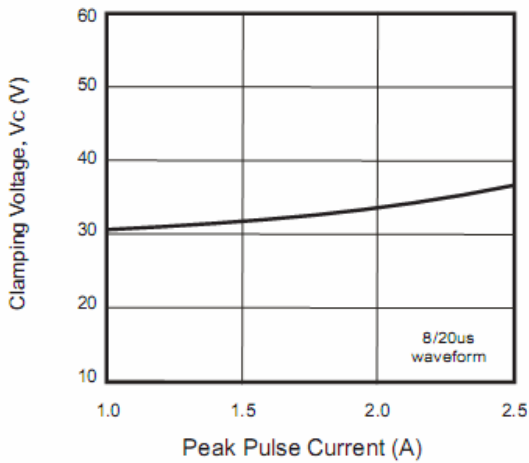

Fig.4 - Capacitance Between Terminals Characteristics

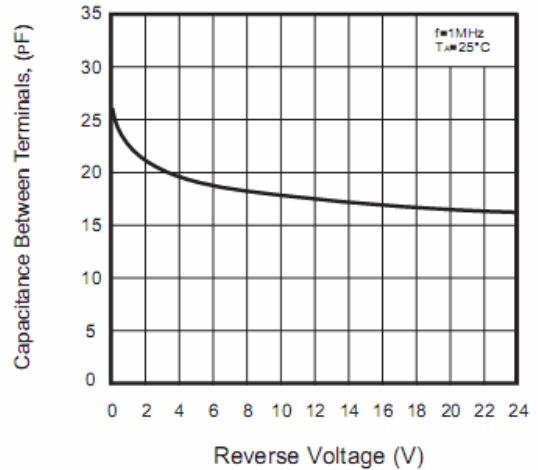
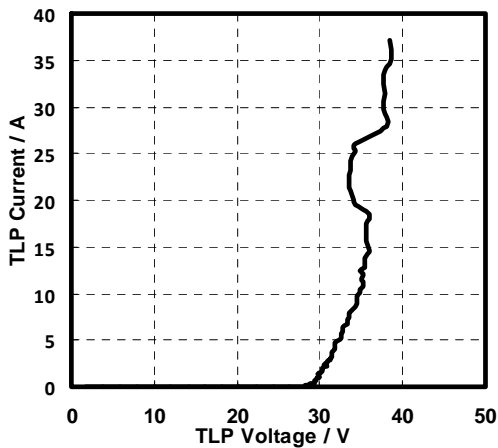
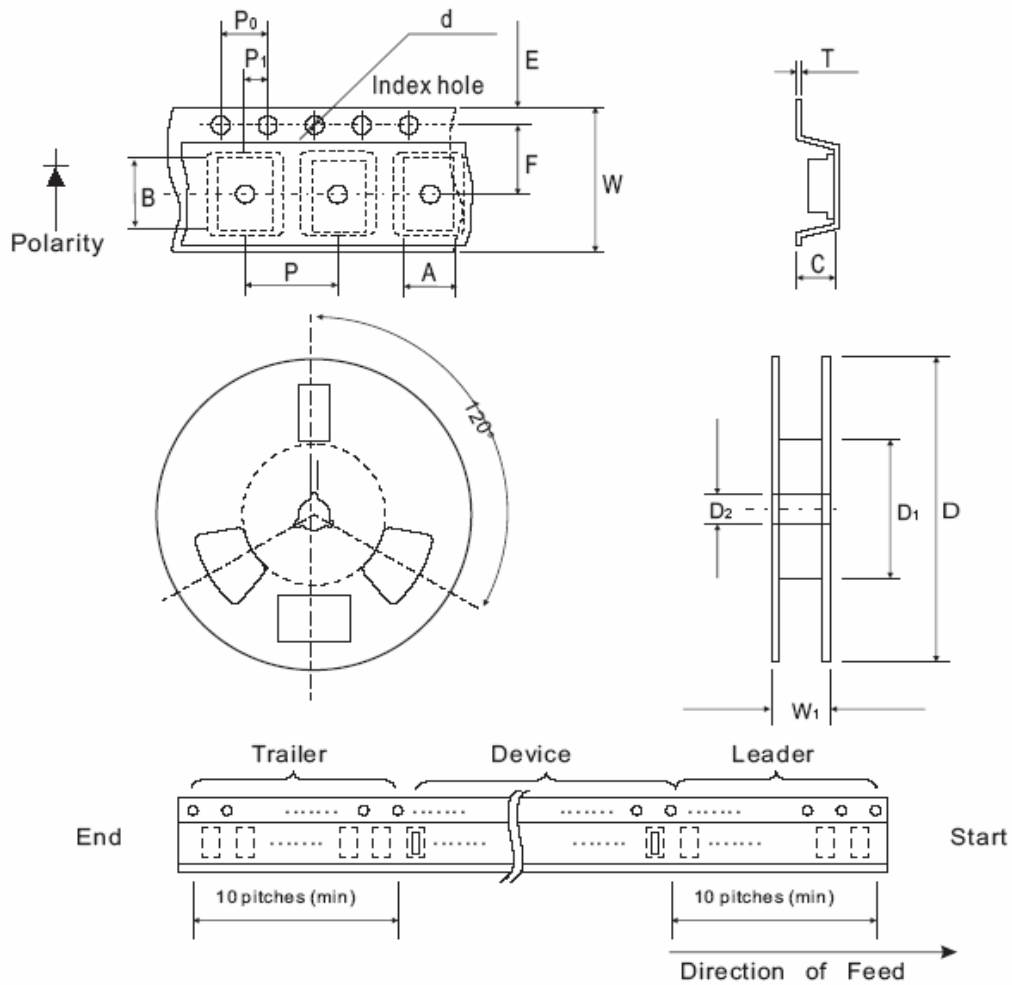

Fig.5 - TLP Measurement





Packing Specification



Tape & Reel Dimensions

Package	Unit	A	B	C	d	D
DFN1006	mm	0.67±0.10	1.12±0.10	0.60±0.10	1.50±0.10	178±1
	inch	0.026±0.004	0.044±0.004	0.024±0.004	0.060±0.004	7.008±0.04

Package	Unit	D1	D2	E	F	P
DFN1006	mm	60MIN	13.0±0.20	1.75±0.10	3.5±0.10	4.0±0.10
	inch	2.362MIN	0.512±0.008	0.069±0.004	0.138±0.004	0.157±0.004

Package	Unit	P0	P1	T	W	W1
DFN1006	mm	4.0±0.10	2.0±0.10	0.22±0.03	8.0±0.10	10.5±0.5
	inch	0.157±0.004	0.079±0.004	0.009±0.002	0.315±0.004	0.413±0.02

**Standard Package**

Package	Reel Size	Qty/Reel
DFN1006	7"	5,000 pcs

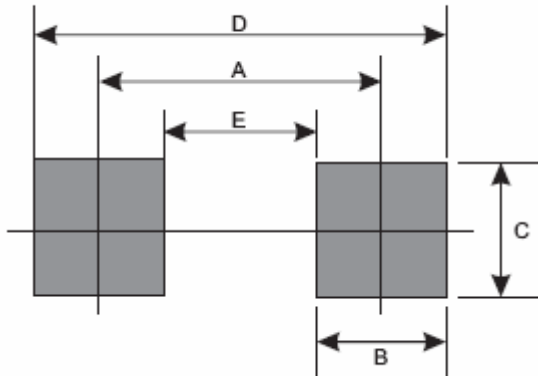
Recommended Soldering Footprint**Reflow Soldering**

Product Size	Dimension/ mm				
	A	B	C	D	E
DFN1006	0.750	0.500	0.700	1.250	0.250
	0.030"	0.020"	0.028"	0.049"	0.010"

Marking Code

Part Number	Marking Code
ESDQR24V0U	E4

**Disclaimers**

These products are not designed for use in applications where any failure or malfunction may result in personal injury, death or severe property or environmental damage such as medical, military, aircraft, space or life support equipments.

单击下面可查看定价，库存，交付和生命周期等信息

[>>LIZ\(丽智\)](#)