

JL-208-IP66 NEMA 接口 短路帽 (IP66 等级)



产品介绍



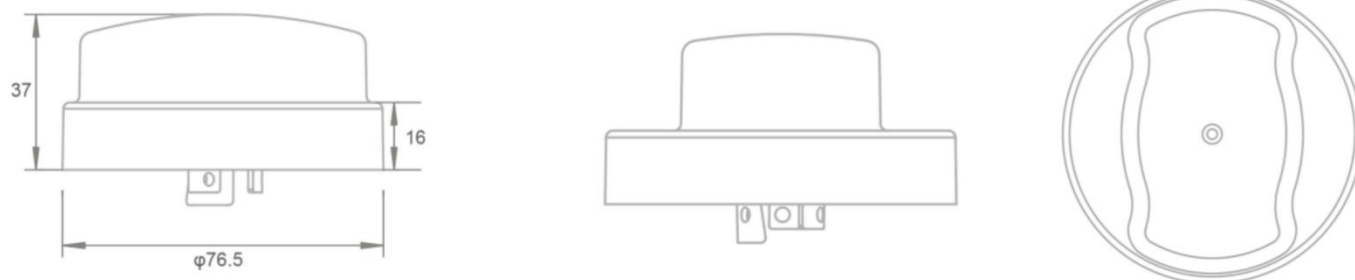

- 对暂未加装灯控器的 NEMA 插座提供电源导通和防护
- ANSI C136.10 及 C136.41 通用
- 安装后可实现 IP66 的防护等级
- 紫外线稳定的聚碳酸酯外壳
- 高抗冲击 PBT 基座
- 符合人体工学的扭把

三视线稿图



参数表

产品编号	JL-208-IP66
额定负载	7200W 钨丝灯, 7200VA 镇流器灯

额定电压	0~480VAC
额定频率	50/60Hz
工作温度	-40°C ~ +70°C
工作湿度	96%
外壳材质	PC
IP 等级	IP66
认证	    

安装说明

- 断开电源
- 根据下图连接插座
- 将短路帽推上并顺时针旋转，将其旋锁在插座中

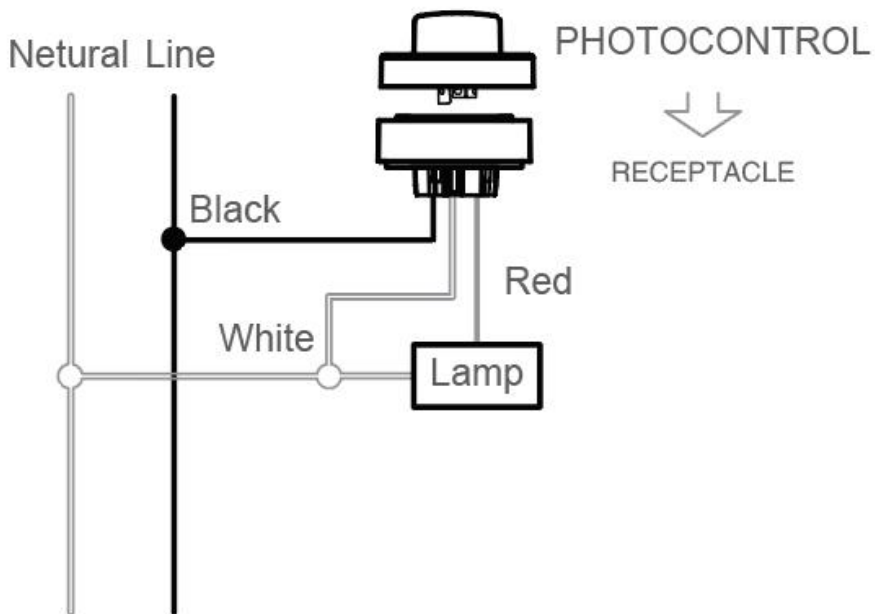

单击下面可查看定价，库存，交付和生命周期等信息

[>>LONGJOIN\(朗俊智能\)](#)