



### Features

- OVP Threshold: 6.1V
- Over Current Protection
- OVP Threshold Time Less Than 1µs
- Low RDS(ON): 135mΩ @ 5V /1A
- Output Discharge
- Thermal Fault Protection
- SOT23-6 Package
- RoHS Compliant and 100% Lead (Pb)-Free

### Applications

- Portable Devices
- GPS
- Digital Cameras
- Tablets
- Mobile Phones

### Description

The LP5300F is an Over-Voltage-Protection (OVP) and Over-Current-Protection (OCP) device. The device will switch off internal MOSFET to disconnect VIN to VOUT to protect load when any of input voltage, input current over the threshold. The over temperature protection (OTP) function monitors chip temperature to protect the device.

Other features include under-voltage lockout (UVLO).

The LP5300F is available in SOT-23-6 package. Standard products are Pb-free and Halogen-free.

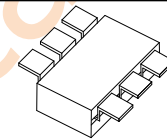

SOT23-6  
0.95mm pin pitch

### Typical Application Circuit

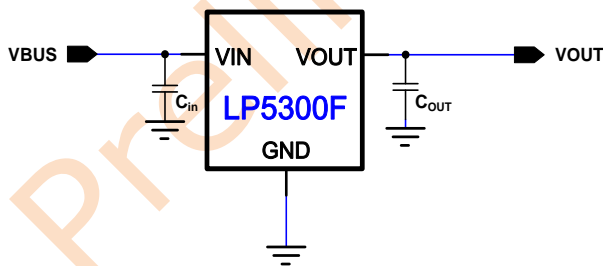

### Ordering Information

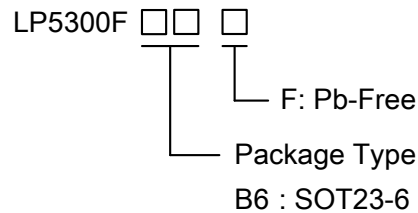

### Marking Information

Device	Marking	Package	Shipping
LP5300FB6F	LPS 8FYWX	SOT23-6	3K/REEL
Marking indication: Y is year code. W is week code. X is series number.			



## Pin Configuration

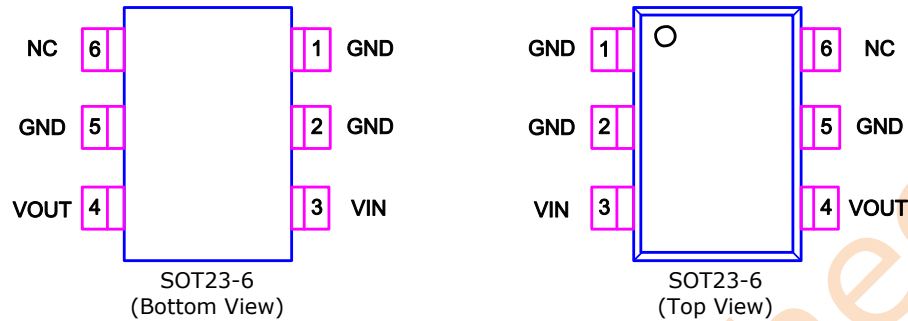

## Pin Description

Pin No.	Name	Description
1,2,5	GND	Ground pad.
3	VIN	Power source input. Connect a ceramic capacitor between VIN and GND.
4	VOUT	Output through the power MOSFET. Bypass VOUT to GND with a ceramic capacitor.
6	NC	No connector. These pin must be floating. Connect to GND will be disable OCP function.

## Functional Block Diagram

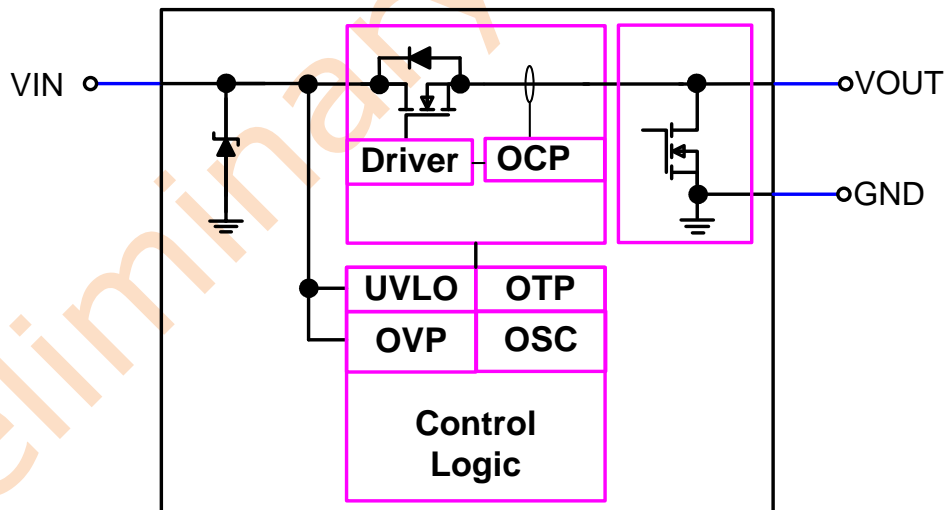



## Absolute Maximum Ratings (Note 1)

- VIN to GND ----- -0.3V to 26V
- VOUT to GND ----- -0.3V to 7V
- Maximum Junction Temperature (T<sub>J</sub>) ----- 125°C
- Operating Ambient Temperature Range (T<sub>A</sub>) ----- -40°C to 85°C
- Maximum Soldering Temperature (At leads, 10 sec) ----- 260°C

\*Note 1: Stresses beyond those listed under “Absolute Maximum Ratings” may cause permanent damage to the device. These are stress ratings only, and functional operation of the device at these or any other conditions beyond those indicated in the operational sections of the specifications is not implied. Exposure to absolute maximum rating conditions for extended periods may affect device reliability.

## Thermal Information

- Maximum Power Dissipation (P<sub>D</sub>, T<sub>A</sub> ≤ 25°C) ----- 0.4W
- Thermal Resistance (θ<sub>JA</sub>) (Note 2) ----- 250°C/W

Preliminary Datasheet



## Electrical Characteristics

The parameters are measured under conditions  $V_{IN} = 5V$ ,  $C_{IN} = C_{OUT} = 1\mu F$ ,  $T_A = 25^\circ C$ , unless otherwise specified.

Parameter	Symbol	Test Conditions	Min	Typ.	Max	Units
<b>General Function</b>						
Input Voltage	$V_{IN}$	$T_J = +25^\circ C$	3.7	5	20	V
Input UVLO Threshold	$V_{UVLO}$	$V_{IN}$ Rising		3.5		V
UVLO Threshold Hysteresis	$\Delta V_{UVLO}$	Falling Hysteresis		200		mV
Soft Start Time	$T_{SS}$			8		ms
Input Quiescent Current	$I_Q$	No loading		200		$\mu A$
Thermal Shutdown Threshold	$T_{SD}$	No loading		150		$^\circ C$
Thermal Shutdown Threshold Hysteresis	$\Delta T_{SD}$			20		$^\circ C$
<b>Power MOS</b>						
Switch On Resistance	$R_{DS(ON)}$	$I_{OUT} = 1A$		135		m $\Omega$
Output Discharge Resistance	$R_{DIS}$			2		k $\Omega$
<b>Protection Functions</b>						
Input Over Voltage Protect threshold	$V_{IOVP}$	$V_{IN}$ from 5V to 8V		6.1		V
Input OVP threshold Hysteresis	$\Delta V_{IOVP}$	$V_{IN}$ from 8V to 5V		100		mV
Input OVP propagation delay	$T_{OVP}$	$V_{IN} = 5V \rightarrow 8V$			1	$\mu s$
OVP recovery time	$T_{ON(OVP)}$	$V_{IN} = 8V \rightarrow 5V$ to output on		8		ms
Over Current Protection	$I_{OCP}$			3		A
OCP Active Time	$T_{OCP}$			30		ms
OCP Recovery Time	$T_{ON(OCP)}$			1		s

Package Dimensions

SOT23-6 Package (Unit: mm)

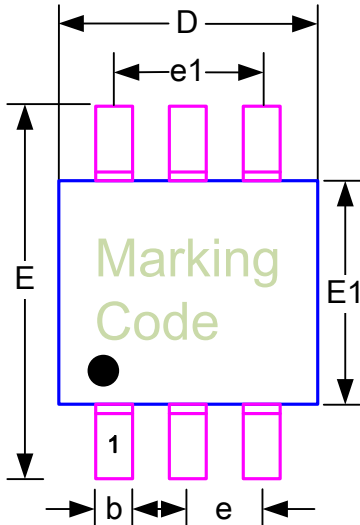

SYMBOLS UNIT	DIMENSION IN MILLIMETER		
	MIN	NOM	MAX
A	--	--	1.350
A1	0.040	--	0.150
A2	0.900	1.100	1.300
b	0.300	--	0.480
c	0.080	--	0.210
D	2.720	2.920	3.120
E	2.600	2.800	3.000
E1	1.400	1.600	1.800
e	0.950 BSC		
e1	1.800	1.900	2.000
L	0.300	--	0.610

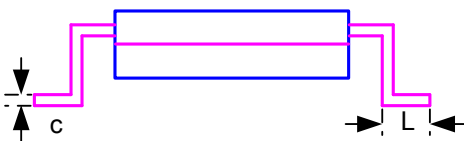
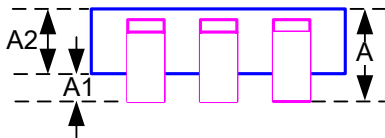

单击下面可查看定价，库存，交付和生命周期等信息

[>>LOW POWER\(微源半导体\)](#)