



1.2MHz,30V/1.4A High Performance, Boost Converter

General Description

The LP3316 is a 1.2MHz PWM boost switching regulator designed for constant-voltage boost applications. The LP3316 can drive a string of LED up to 30V. The LP3316 implements a constant frequency 1.2MHz PWM control scheme. The high frequency PWM operation also saves board space by reducing external component size. To improve efficiency, the feedback voltage is set to 1250 mV, which reduces the power dissipation at the voltage setting resistor.

Highly integration and internal compensation network minimizes as 6 external component counts. Optimized operation frequency can meet the requirement of small LC filters value and low operation current with high efficiency.

Order Information

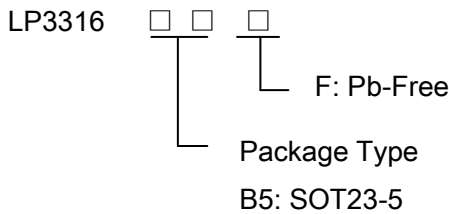

Applications

- ✧ Panel Bias Voltage supply
- ✧ OLED Backlight driver
- ✧ Notebook Computers
- ✧ Portable Applications
- ✧ MID/PTV

Features

- ◆ High Efficiency: 95%
- ◆ 1.2MHz Fixed-Frequency PWM Operation
- ◆ Maximum Output Voltage up to 30V
- ◆ Guaranteed 13V/200mA Output with 5V input
- ◆ Operating Range : 2.5V to 5.5V
- ◆ Shutdown Supply Current:<1uA
- ◆ Programmable Soft-star
- ◆ Available in SOT23-5 Package
- ◆ Minimize the External Component
- ◆ RoHS Compliant and 100% Lead (Pb)-Free

Typical Application Circuit

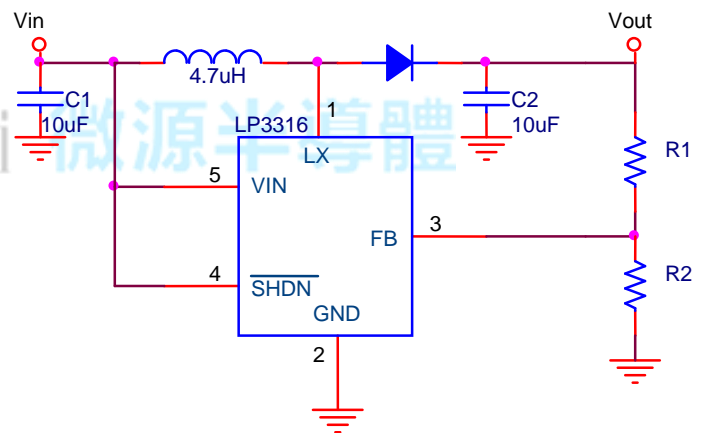

Marking information

Device	Marking	Package	Shipping
LP3316		SOT23-5	3K/REEL
Y: Year code. W: Weeks code. X: Series number code.			

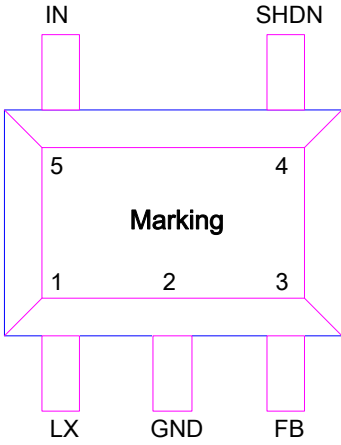

Functional Pin Description

Package Type	Pin Configurations
SOT23-5	

Pin Description

Pin	Name	Description
1	LX	Switch Pin. Connect this Pin to inductor and catch diode. Minimize the track area to reduce EMI.
2	GND	Ground Pin
3	FB	Feedback Reference Voltage Pin. Series connect a resistor between Vout and ground as a voltage sense. The feedback voltage is 1250mV.
4	/SHDN	Chip Enable (Active High). Voltage sensing input to trigger the function of over voltage protection. Note that this pin is high impedance. There should be a pull low 100kΩ resistor connected to GND when the control signal is floating.
5	Vin	Supply Input Voltage Pin. Bypass 1uF capacitor to GND to reduce the input noise.



Function Block Diagram

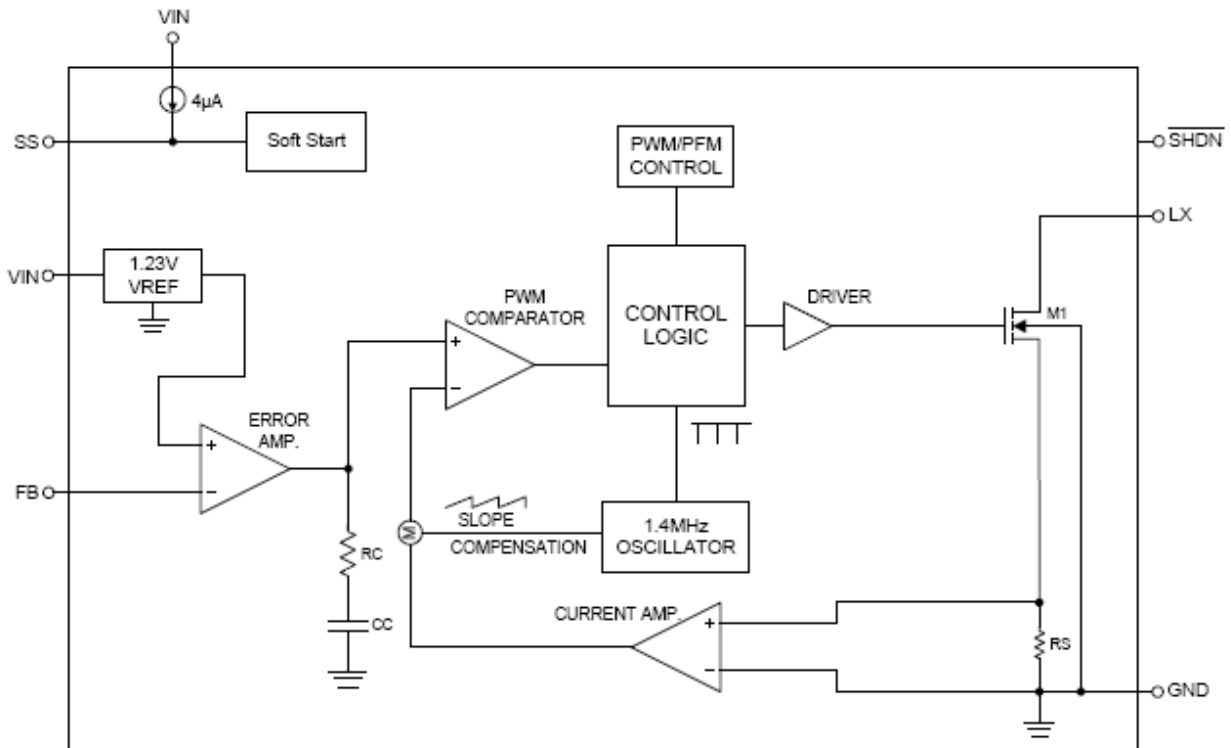

Absolute Maximum Ratings

- ✧ Supply Input Voltage ----- -0.3V to 7.0V
- ✧ LX Input Voltage ----- -0.3V to 36V
- ✧ The Other Pins ----- -0.3V to 5.5V
- ✧ Power Dissipation, PD @ TA = 25°C TSOT-23-5/6 ----- 0.45W
- ✧ Lead Temperature (Soldering, 10 sec.) ----- 260°C
- ✧ Operation Temperature Range ----- -40°C to 80°C
- ✧ Storage Temperature Range ----- -65°C to 150°C



Electrical Characteristics

Parameter	Symbol	Test Condition	Min	Typ.	Max	Units
System Supply Input						
Operation voltage Range	VDD		2.5		6	V
Under Voltage Lock Out	VDD		1.8	2	2.3	V
Supply Current	IDD	FB=1.3V,no Switch		430	550	uA
Shut Down Current	IDD	VEN < 0.4V		0.1	1	uA
Line Regulation		VIN : 3.0~4.3V		2		%
Oscillator						
Operation Frequency	FOSC			1.2		MHz
Maximum Duty Cycle			90			%
Feedback Voltage	LP3316		1.21		1.27	V
MOSFET						
On Resistance of MOSFET	RDS(ON)			0.5	0.7	Ω
SW Current Limit	ILM			1.4		A
Protection						
Shut Down Voltage	VEN				0.3	V
Enable on Voltage	VEN		1.0			V



Typical Operating Characteristics

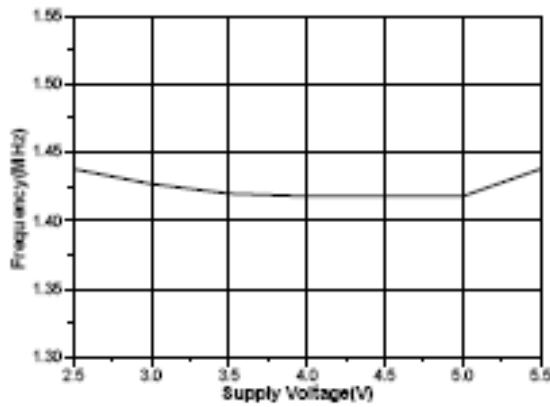

Frequency vs. Supply Voltage

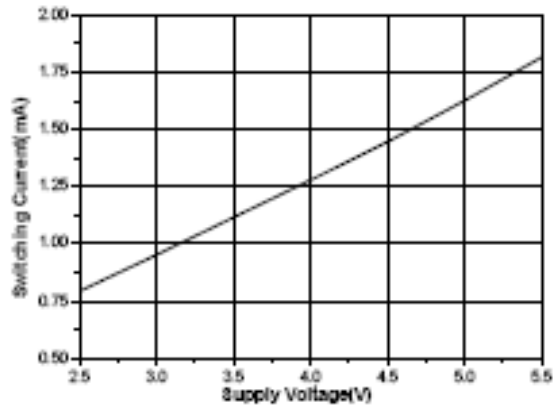

Switching Current vs. Supply voltage

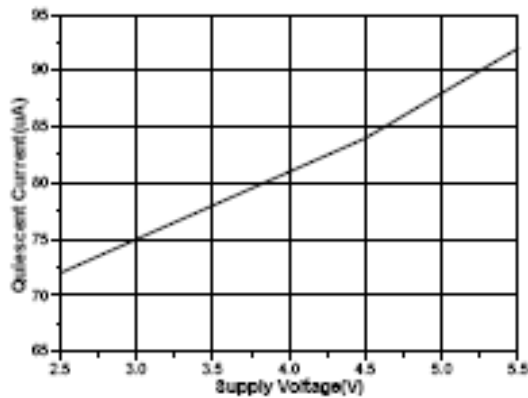

Non-Switching Current vs. Supply Voltage

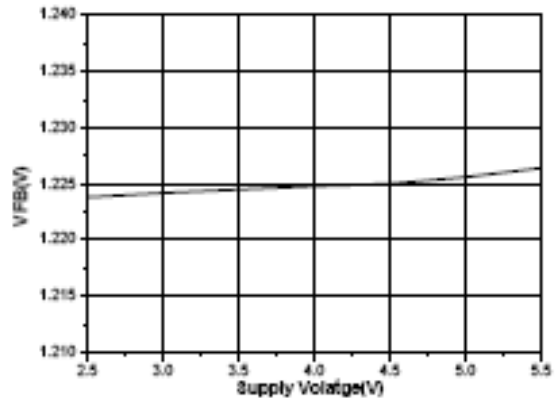

Feedback Voltage vs. Supply Voltage

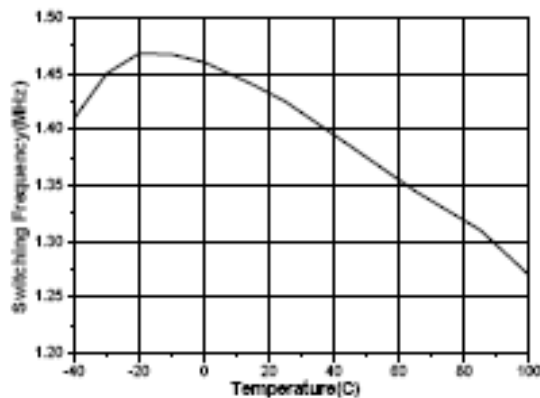

Switching Frequency vs. Temperature

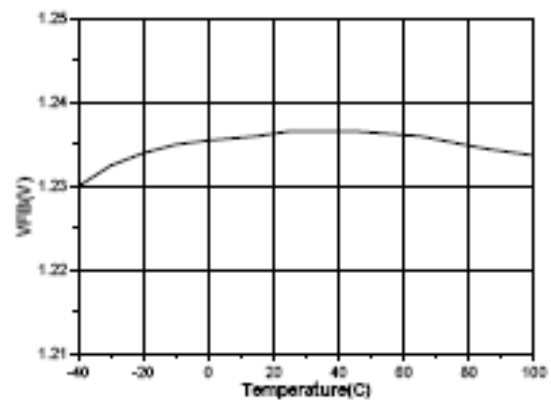

Feedback Voltage vs. Temperature

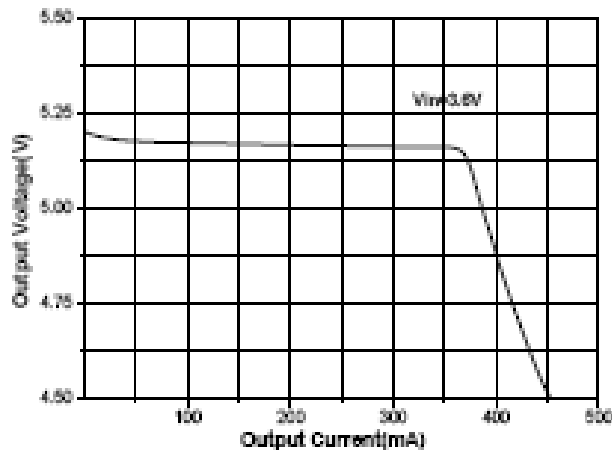

Load Regulation (Vo=5V)

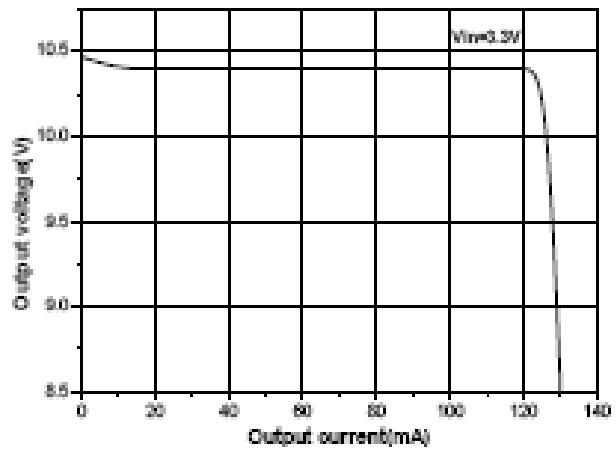

Load Regulation (Vo=10V)

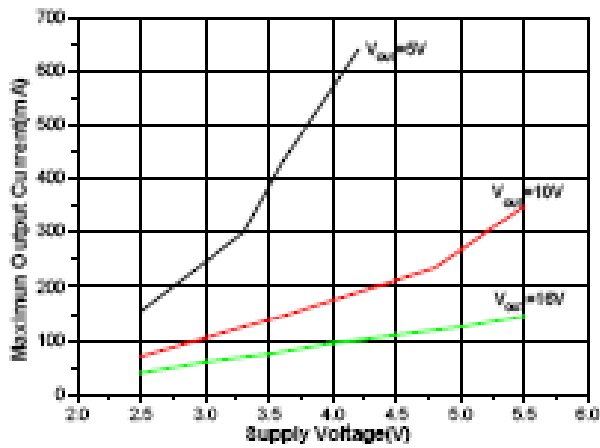

Maximum Output Current vs. Supply Voltage

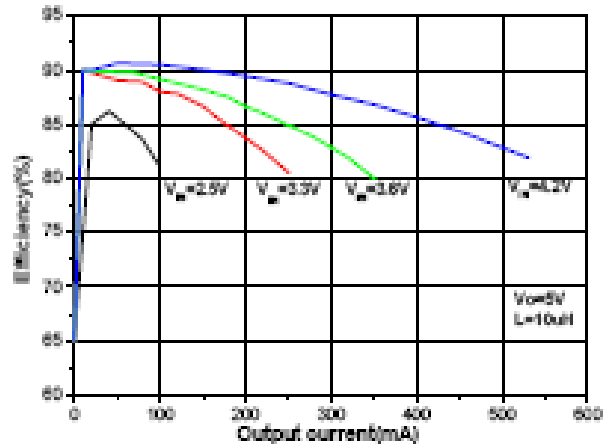

Efficiency vs. Output Current (Vo=5V)

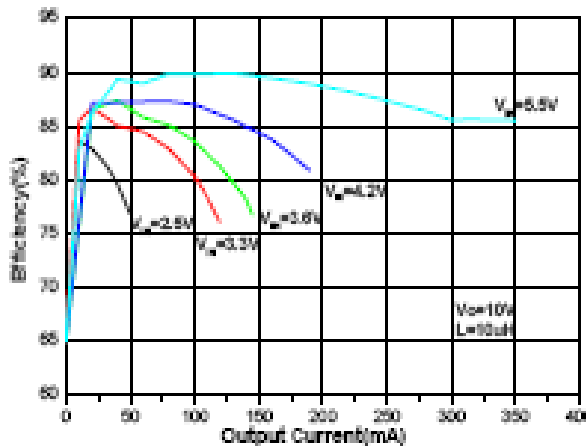

Efficiency vs. Output Current (Vo=10V)

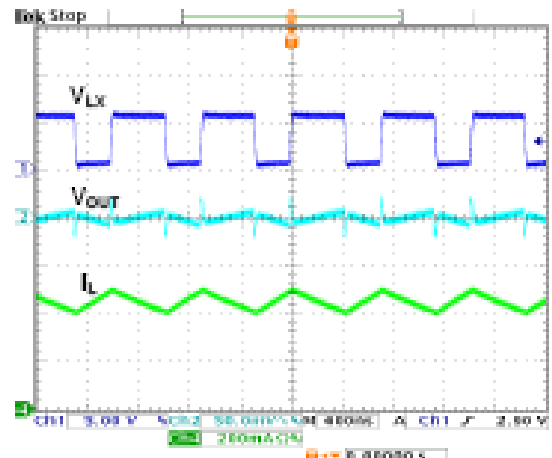

Operation Waveform

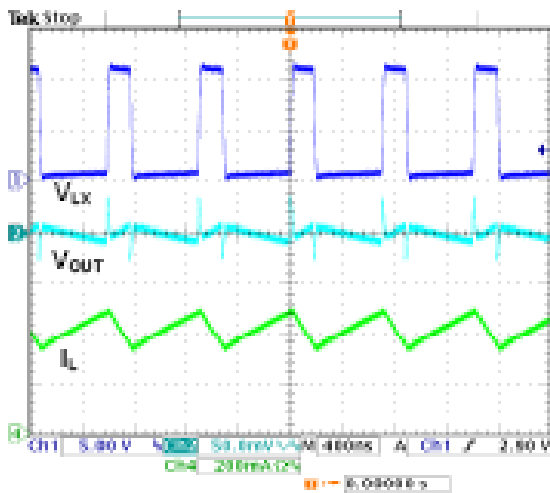

$V_{IN}=3.3V, V_O=10V, I_O=100mA, L1=10\mu H$

Operation Waveform

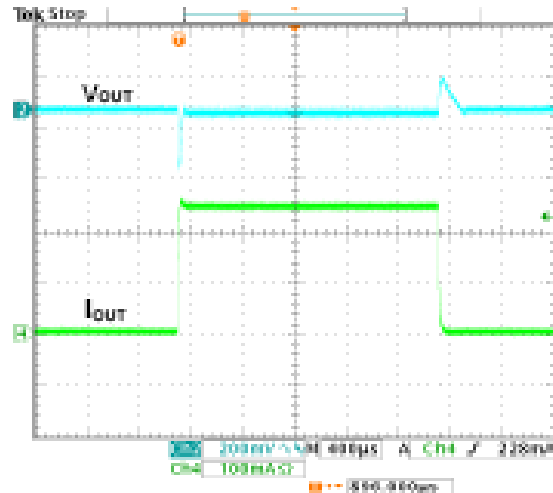

$V_{IN}=3.6V, V_O=5V, I_O=5 \text{ to } 250mA, CFF=220pF$

Load Step Response

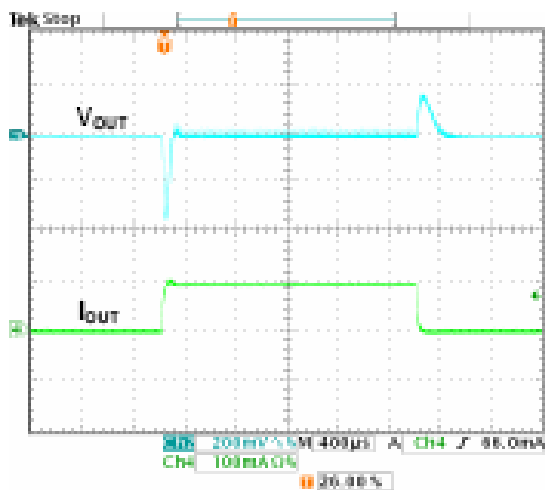

$V_{IN}=3.3V, V_O=10V, I_O=5 \text{ to } 250mA, CFF=220pF$

Load Step Response

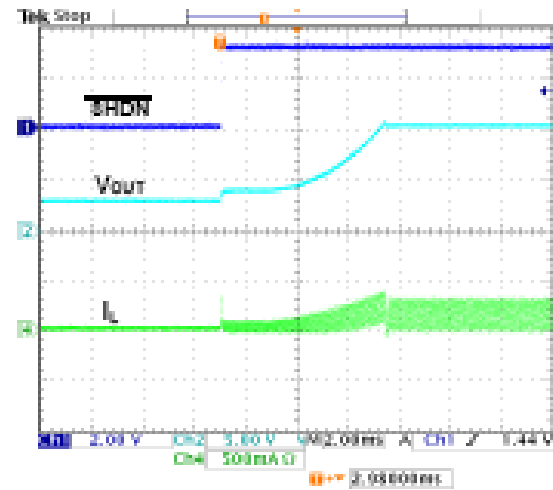

$V_{IN}=3.3V, V_{OUT}=10V, I_O=50mA, C58=33nF$

Start-Up from Shutdown

Applications Information

Inductor Selection

The recommended value of inductor for 30V applications are 4.7 to 22µH. Small size and better efficiency are the major concerns for portable device, such as LP3316 used for mobile phone. The inductor should have low core loss at 1.2MHz and low DCR for better efficiency. Inductor saturation current rating should be considered.



Packaging Information

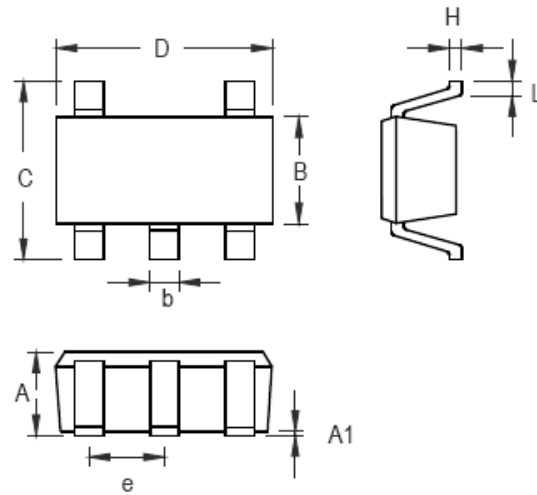

Symbol	Dimensions In Millimeters		Dimensions In Inches	
	Min	Max	Min	Max
A	0.889	1.295	0.035	0.051
A1	0.000	0.152	0.000	0.006
B	1.397	1.803	0.055	0.071
b	0.356	0.559	0.014	0.022
C	2.591	2.997	0.102	0.118
D	2.692	3.099	0.106	0.122
e	0.838	1.041	0.033	0.041
H	0.080	0.254	0.003	0.010
L	0.300	0.610	0.012	0.024

SOT-23-5 Surface Mount Package

单击下面可查看定价，库存，交付和生命周期等信息

[>>LOW POWER\(微源半导体\)](#)