



## 300mA, Ultra-low noise, Small Package Ultra-Fast CMOS LDO Regulator

### General Description

The LP3990 is designed for portable RF and wireless applications with demanding performance and space requirements. The LP3990 performance is optimized for battery-powered systems to deliver ultra low noise and low quiescent current. The LP3990 also works with low-ESR ceramic capacitors, reducing the amount of board space necessary for power applications, critical in hand-held wireless devices. The LP3990 consumes less than 0.01µA in shutdown mode and has fast turn-on time less than 50µs. The other features include ultra low dropout voltage, high output accuracy, current limiting protection, and high ripple rejection ratio. It is available in the 1mm × 1mm X2SON packages.

### Features

- ◆ Ultra-thin Package
- ◆ 2V- 5.5V Input Voltage Range
- ◆ Low Dropout : 130mV @ 200mA
- ◆ 1.2V, 1.5V, 1.8V, 2.5V, 2.8V,3.0V,3.3V, 3.6V and 5V Fixed
- ◆ 300mA Output Current, 450mA Peak Current
- ◆ High PSSR:-75dB at 1KHz
- ◆ < 0.01uA Standby Current When Shutdown
- ◆ Available in 1mm×1mm X2SON Package
- ◆ TTL-Logic-Controlled Shutdown Input
- ◆ Ultra-Fast Response in Line/Load transient
- ◆ Current Limiting and Thermal Shutdown Protection
- ◆ Quick start-up (typically 50uS)

### Order Information

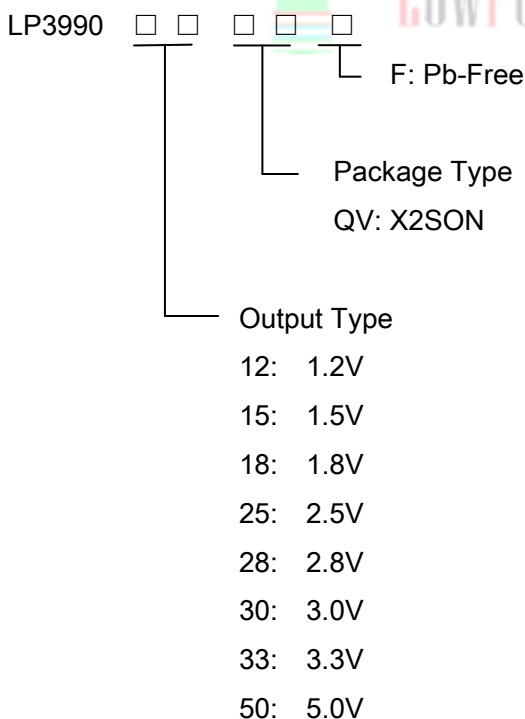

### Applications

- ◇ Portable Media Players/MP3 players
- ◇ Cellular and Smart mobile phone
- ◇ LCD
- ◇ DSC Sensor
- ◇ Wireless Card

### Typical Application Circuit

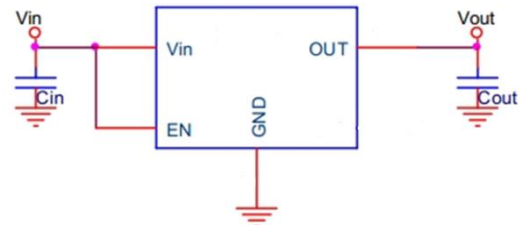

### Marking Information

Device	Marking	Package	Shipping
LP3990-18QVF	CXX	X2SON	10K/REEL
LP3990-30QVF	GXX	X2SON	10K/REEL
X: Series numbers.			

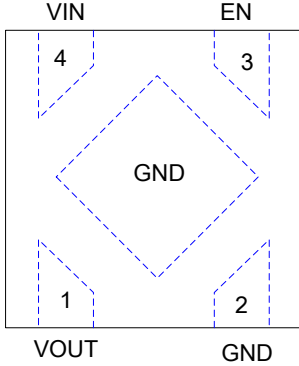

## Functional Pin Description

Package Type	Pin Configurations
1mm×1mm X2SON	

## Pin Description

Pin	Name	Description
1	VOUT	Output Voltage.
2	GND	Ground.
3	EN	Chip Enable (Active High). Note that this pin is high impedance.
4	VIN	Power Input Voltage.

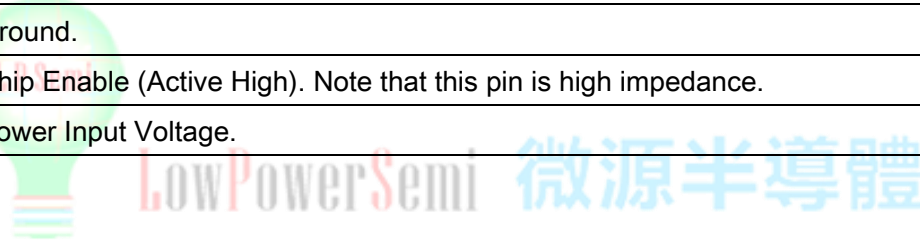



### Function Diagram

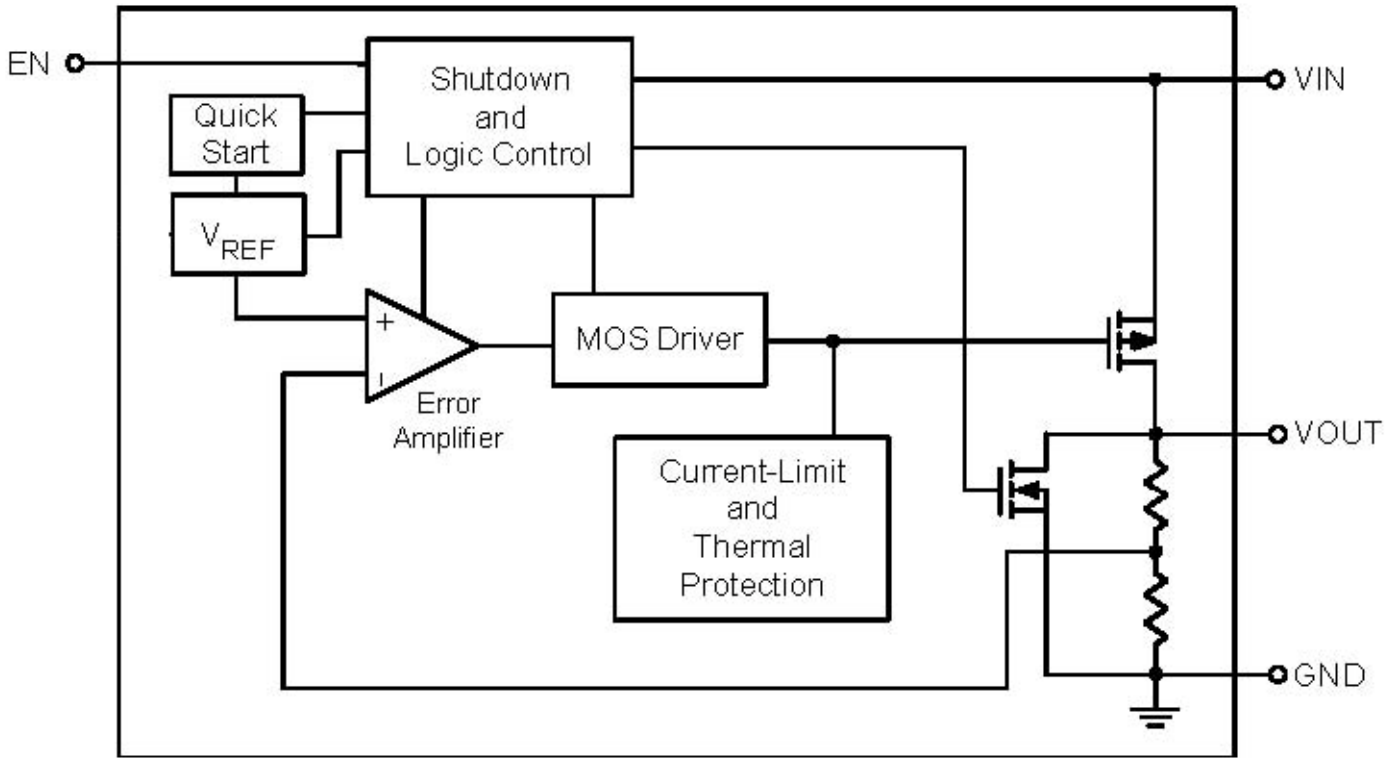

### Absolute Maximum Ratings

- ◇ Supply Input Voltage ----- 6V
- ◇ EN Pin Voltage ----- -0.3V to Vin+0.3V
- Power Dissipation, PD @ TA = 25°C**
- ◇ X2SON ----- 390mW
- Package Thermal Resistance**
- ◇ X2SON,  $\theta_{JA}$  ----- 256°C/W
- ◇ Lead Temperature (Soldering, 10 sec.) ----- 260°C
- ◇ Storage Temperature Range ----- -60°C to 165°C

#### ESD Susceptibility

- ◇ HBM (Human Body Mode) ----- 2kV
- ◇ MM(Machine-Mode) ----- 200V

#### Recommended Operating Conditions

- ◇ Supply Input Voltage ----- 2.5V to 5.5V
- ◇ EN Input Voltage ----- 0V to 5.5V
- ◇ Operation Junction Temperature Range ----- -40°C to 125°C
- ◇ Operation Ambient Temperature Range ----- -40°C to 85°C



## Electrical Characteristics

(VIN = VOUT + 1V, CIN = COUT = 1μF, TA = 25° C, unless otherwise specified)

Parameter		Symbol	Test Conditions	Min	Typ.	Max	Units
Output Voltage Accuracy		ΔVOUT	IOUT = 1mA	-2	--	+2	%
Output Loading Current		ILOAD	VEN=VIN, VIN>2.5V		300		mA
Current Limit		ILIM	RLOAD = 1Ω	350	450		mA
Quiescent Current		IQ	VEN ≥ 1.2V, IOUT = 0mA		50		μA
Dropout Voltage		VDROP	IOUT = 200mA, VOUT > 2.8V		130	200	mV
			IOUT = 300mA, VOUT > 2.8V		220	300	
Line Regulation		ΔVLINE	VIN = (VOUT + 1V) to 5.5V, IOUT = 1mA			0.2	%
Load Regulation		ΔLOAD	1mA < IOUT < 200mA			2	%
Standby Current		ISTBY	VEN = GND, Shutdown		0.01	1	μA
EN Input Bias Current		IIBSD	VEN = GND or VIN		2	3.5	μA
EN Threshold	Logic-Low Voltage	VIL	VIN = 3V to 5.5V, Shutdown			0.4	V
	Logic-High Voltage	VIH	VIN = 3V to 5.5V, Start-Up	1.4			
Output Noise Voltage			10Hz to 100kHz, IOUT = 200mA, COUT = 1μF		100		uVRMS
Power Supply Rejection Rate	f = 1kHz	PSRR	COUT = 1μF, IOUT = 10mA		-75		dB
	f = 10kHz				-68		
Thermal Shutdown Temperature		TSD			150		°C



## Typical Operating Characteristics

### Output Voltage Vs. Temperature

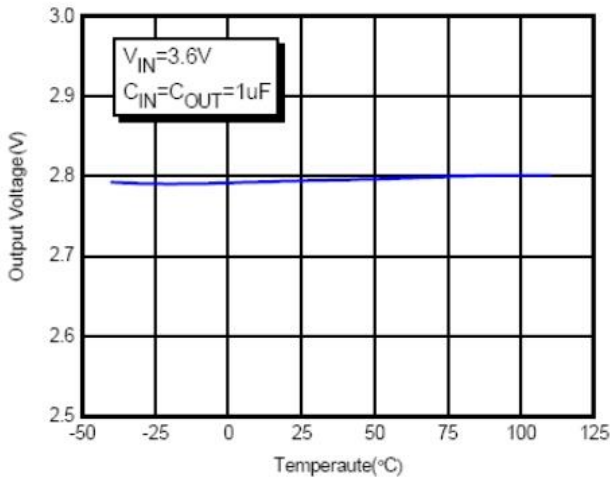

### Quiescent Current Vs. Temperature

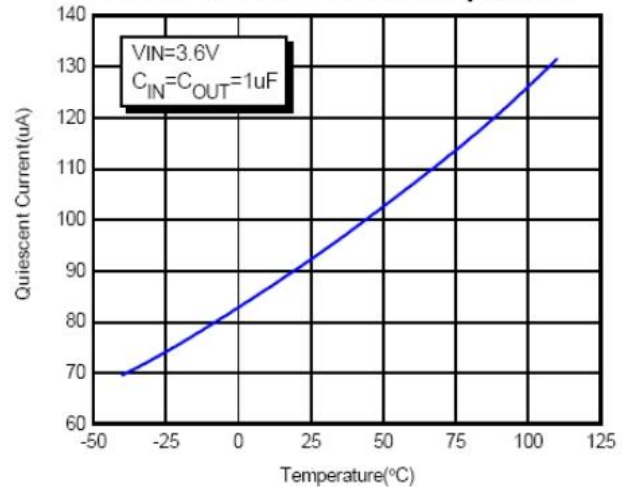

### Dropout Voltage Vs. Load Current

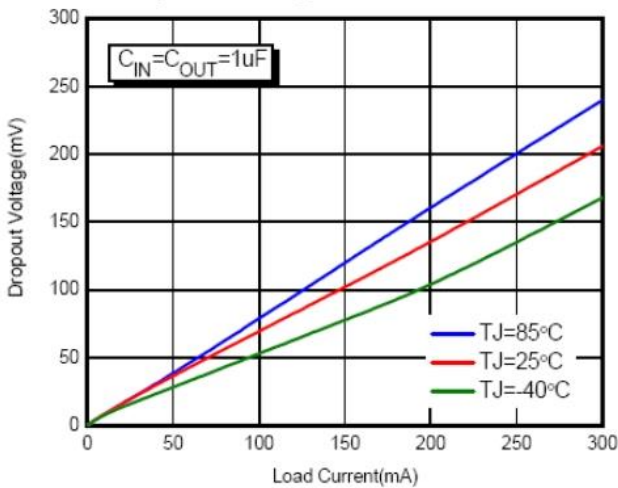

### PSRR

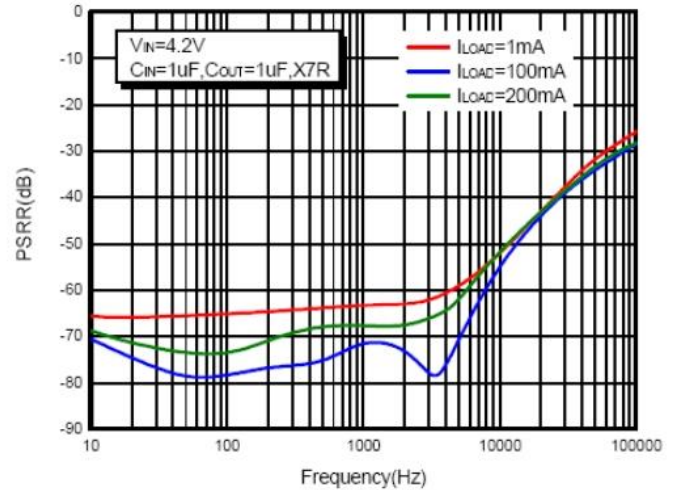

### VOU vs. VIN

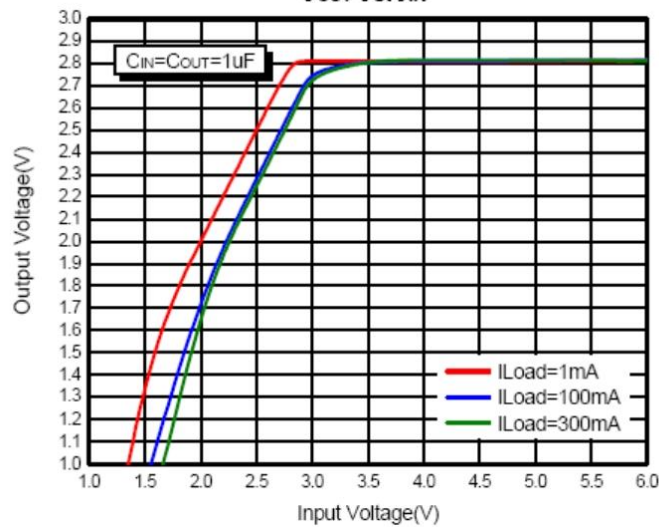



## Applications Information

Like any low-dropout regulator, the external capacitors used with the LP3990 must be carefully selected for regulator stability and performance. Using a capacitor whose value is  $> 1\mu\text{F}$  on the LP3990 input and the amount of capacitance can be increased without limit. The input capacitor must be located a distance of not more than 0.5 inch from the input pin of the IC and returned to a clean analog ground. Any good quality ceramic or tantalum can be used for this capacitor. The capacitor with larger value and lower ESR (equivalent series resistance) provides better PSRR and line-transient response. The output capacitor must meet both requirements for minimum amount of capacitance and ESR in all LDOs application. The LP3990 is designed specifically to work with low ESR ceramic output capacitor in space-saving and performance consideration. Using a ceramic capacitor whose value is at least  $1\mu\text{F}$  with ESR is  $> 25\text{m}\Omega$  on the LP3990 output ensures stability. The LP3990 still works well with output capacitor of other types due to the wide stable ESR range. Output capacitor of larger capacitance can reduce noise and improve load transient response, stability, and PSRR. The output capacitor should be located not more than 0.5 inch from the VOUT pin of the LP3990 and returned to a clean analog ground.

### Start-up Function Enable Function

The LP3990 features an LDO regulator enable/disable function. To assure the LDO regulator will switch on, the EN turn on control level must be greater than 1.4 volts. The LDO regulator will go into the shutdown mode when the voltage on the EN pin falls below 0.4 volts. For protecting the system, the LP3990 have a quick-discharge function. If the enable function is not needed in a specific application, it may be tied to VIN to keep the LDO regulator in a continuously on state.

### Thermal Considerations

Thermal protection limits power dissipation in LP3990. When the operation junction temperature exceeds  $150^\circ\text{C}$ , the OTP circuit starts the thermal shutdown function turn the pass element off. The pass element turns on again after the junction temperature cools by  $25^\circ\text{C}$ . For continue operation, do not exceed absolute maximum operation junction temperature  $125^\circ\text{C}$ .

The power dissipation definition in device is:

$$PD = (V_{IN} - V_{OUT}) \times I_{OUT} + V_{IN} \times I_Q$$

The maximum power dissipation depends on the thermal resistance of IC package, PCB layout, the rate of surroundings airflow and temperature difference between junction to ambient.

The maximum power dissipation can be calculated by following formula:

$$PD(\text{MAX}) = (T_J(\text{MAX}) - T_A) / \theta_{JA}$$



### Packaging Information

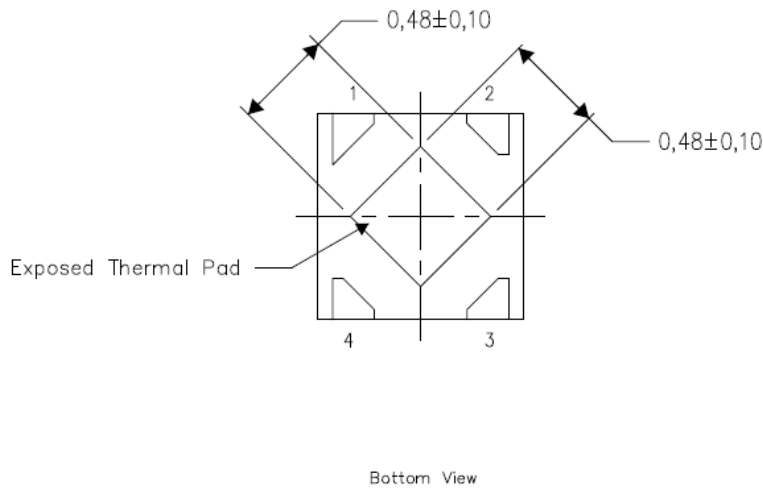
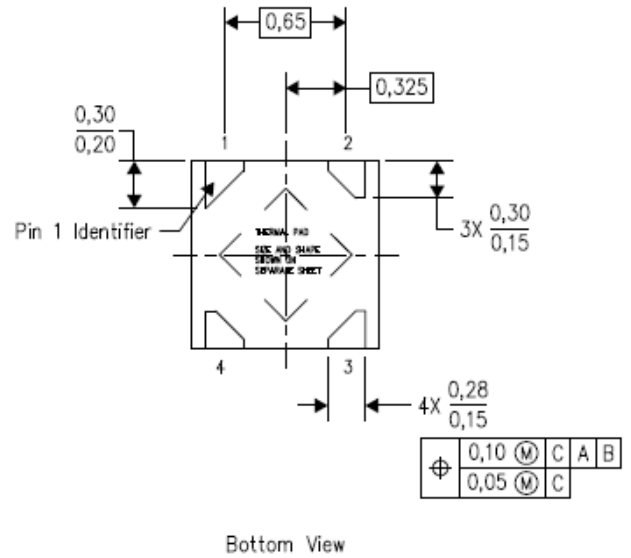
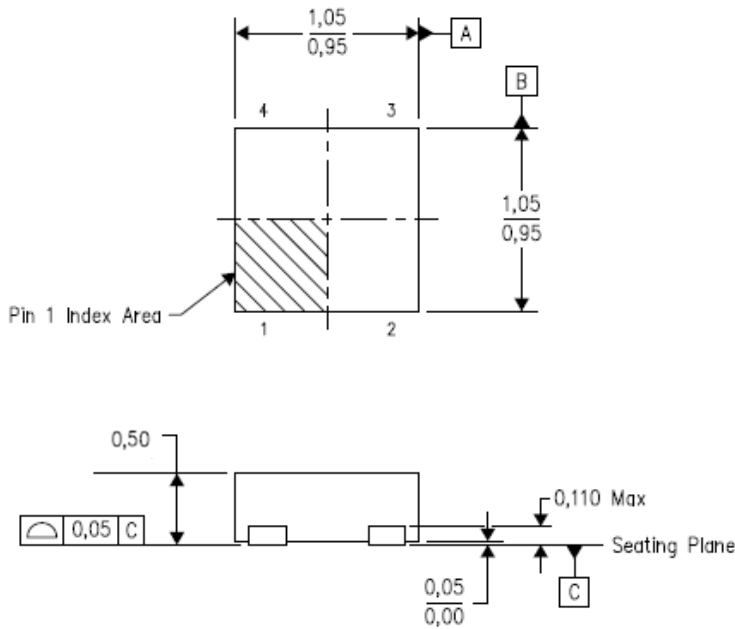

Exposed Thermal Pad Dimensions

微源半導體

单击下面可查看定价，库存，交付和生命周期等信息

[>>LOW POWER\(微源半导体\)](#)