

# Dual General Purpose Transistor

## Features

- We declare that the material of product compliance with RoHS requirements.
- S- Prefix for Automotive and Other Applications Requiring Unique Site and Control Change Requirements; AEC-Q101 Qualified and PPAP Capable.

## MAXIMUM RATINGS

Rating	Symbol	Value		Unit
		2907	2907A	
Collector–Emitter Voltage	$V_{CEO}$	-40	-60	Vdc
Collector–Base Voltage	$V_{CBO}$	-60		Vdc
Emitter–Base Voltage	$V_{EBO}$	-5.0		Vdc
Collector Current — Continuous	$I_C$	-600		mAdc

## THERMAL CHARACTERISTICS

Characteristic	Symbol	Max	Unit
Total Device Dissipation FR–5 Board, (1) $T_A = 25^\circ\text{C}$	$P_D$	225	mW
Derate above $25^\circ\text{C}$		1.8	mW/ $^\circ\text{C}$
Thermal Resistance, Junction to Ambient	$R_{\theta JA}$	556	$^\circ\text{C}/\text{W}$
Total Device Dissipation Alumina Substrate, (2) $T_A = 25^\circ\text{C}$	$P_D$	300	mW
Derate above $25^\circ\text{C}$		2.4	mW/ $^\circ\text{C}$
Thermal Resistance, Junction to Ambient	$R_{\theta JA}$	417	$^\circ\text{C}/\text{W}$
Junction and Storage Temperature	$T_J, T_{stg}$	-55 to +150	$^\circ\text{C}$

## DEVICE MARKING

(S-)LMBT2907DW1T1G = M2B, (S-)LMBT2907ADW1T1G = 2F

## ELECTRICAL CHARACTERISTICS ( $T_A = 25^\circ\text{C}$ unless otherwise noted.)

Characteristic	Symbol	Min	Max	Unit
----------------	--------	-----	-----	------

## OFF CHARACTERISTICS

Collector–Emitter Breakdown Voltage(3) ( $I_C = -10\text{ mAdc}, I_E = 0$ )	$V_{(BR)CEO}$			Vdc
	LMBT2907	-40	—	
	LMBT2907A	-60	—	
Collector–Emitter Breakdown Voltage( $I_C = -10\ \mu\text{Adc}, I_E = 0$ )	$V_{(BR)CBO}$	-60	—	Vdc
Emitter–Base Breakdown Voltage( $I_E = -10\ \mu\text{Adc}, I_C = 0$ )	$V_{(BR)EBO}$	-5.0	—	Vdc
Collector Cutoff Current( $V_{CB} = -30\text{Vdc}, I_{BE(OFF)} = -0.5\text{Vdc}$ )	$I_{CEX}$	—	-50	nAdc
Collector Cutoff Current ( $V_{CB} = -50\text{Vdc}, I_E = 0$ )	$I_{CBO}$			$\mu\text{Adc}$
	LMBT2907	—	-0.020	
	LMBT2907A	—	-0.010	
( $V_{CB} = -50\text{Vdc}, I_E = 0, T_A = 125^\circ\text{C}$ )				
	LMBT2907	—	-20	
	LMBT2907A	—	-10	
Base Current( $V_{CE} = -30\text{Vdc}, V_{EB(OFF)} = -0.5\text{Vdc}$ )	$I_B$	—	-50	nAdc

1. FR–5 = 1.0 x 0.75 x 0.062 in.

2. Alumina = 0.4 x 0.3 x 0.024 in. 99.5% alumina.

3. Pulse Test: Pulse Width  $\leq 300\ \mu\text{s}$ , Duty Cycle  $\leq 2.0\%$ .

LMBT2907DW1T1G  
LMBT2907ADW1T1G  
S-LMBT2907DW1T1G  
S-LMBT2907ADW1T1G

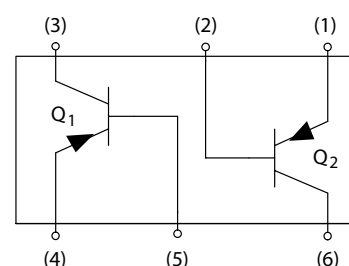
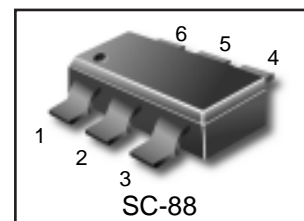

## ORDERING INFORMATION

Device	Packing	Shipping
LMBT2907ADW1T1G S-LMBT2907ADW1T1G	SC88	3000 Units/Reel
LMBT2907ADW1T3G S-LMBT2907ADW1T1G	SC88	10000 Units/Reel

**LMBT2907DW1T1G, LMBT2907ADW1T1G  
S-LMBT2907DW1T1G, S-LMBT2907ADW1T1G**
**ELECTRICAL CHARACTERISTICS** ( $T_A = 25^\circ\text{C}$  unless otherwise noted) (Continued)

Characteristic	Symbol	Min	Max	Unit
<b>ON CHARACTERISTICS</b>				
DC Current Gain ( $I_C = -0.1\text{mA dc}$ , $V_{CE} = -10\text{V dc}$ )	$h_{FE}$	35	—	—
	LMBT2907	75	—	
	LMBT2907A	—	—	
( $I_C = -1.0\text{mA dc}$ , $V_{CE} = -10\text{V dc}$ )	LMBT2907	50	—	
	LMBT2907A	100	—	
( $I_C = -10\text{mA dc}$ , $V_{CE} = -10\text{V dc}$ )	LMBT2907	75	—	
	LMBT2907A	100	—	
( $I_C = -150\text{mA dc}$ , $V_{CE} = -10\text{V dc}$ )(3)	LMBT2907	—	—	
	LMBT2907A	100	300	
( $I_C = -500\text{mA dc}$ , $V_{CE} = -10\text{V dc}$ )(3)	LMBT2907	30	—	
	LMBT2907A	50	—	
Collector-Emitter Saturation Voltage(3) ( $I_C = -150\text{mA dc}$ , $I_B = -15\text{mA dc}$ ) ( $I_C = -500\text{mA dc}$ , $I_B = -50\text{mA dc}$ )	$V_{CE(sat)}$	—	-0.4 -1.6	Vdc
Base-Emitter Saturation Voltage(3) ( $I_C = -150\text{mA dc}$ , $I_B = -15\text{mA dc}$ ) ( $I_C = -500\text{mA dc}$ , $I_B = -50\text{mA dc}$ )	$V_{BE(sat)}$	—	-1.3 -2.6	Vdc

**SMALL-SIGNAL CHARACTERISTICS**

Current-Gain — Bandwidth Product(3),(4) ( $I_C = -50\text{mA dc}$ , $V_{CE} = -20\text{V dc}$ , $f = 100\text{MHz}$ )	$f_T$	200	—	MHz
Output Capacitance ( $V_{CB} = -10\text{V dc}$ , $I_E = 0$ , $f = 1.0\text{MHz}$ )	$C_{obo}$	—	8.0	pF
Input Capacitance ( $V_{EB} = -2.0\text{V dc}$ , $I_C = 0$ , $f = 1.0\text{MHz}$ )	$C_{ibo}$	—	30	pF

**SWITCHING CHARACTERISTICS**

Turn-On Time Delay Time Rise Time	( $V_{CC} = -30\text{V dc}$ , $I_C = -150\text{mA dc}$ , $I_{B1} = -15\text{mA dc}$ )	$t_{on}$ $t^d$ $t_r$	— — —	45 10 40	ns
Fall Time Storage Time Turn-Off Time	( $V_{CC} = -6.0\text{V dc}$ , $I_C = -150\text{mA dc}$ , $I_{B1} = I_{B2} = 15\text{mA dc}$ )	$t_f$ $t_s$ $t_{off}$	— — —	60 225 280	ns

3. Pulse Test: Pulse Width < 300  $\mu\text{s}$ , Duty Cycle < 2.0%.

4.  $f_T$  is defined as the frequency at which  $|h_{fe}|$  extrapolates to unity.

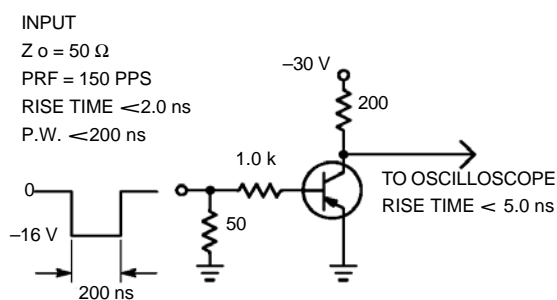

Figure 1. Delay and Rise Time Test Circuit

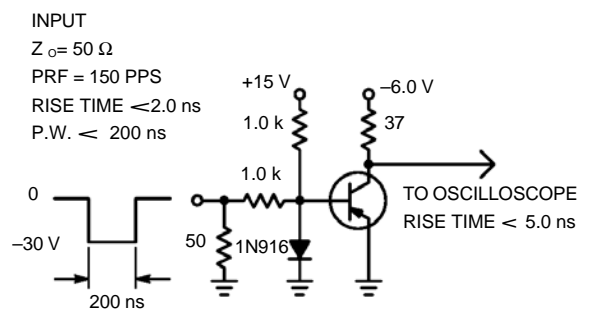
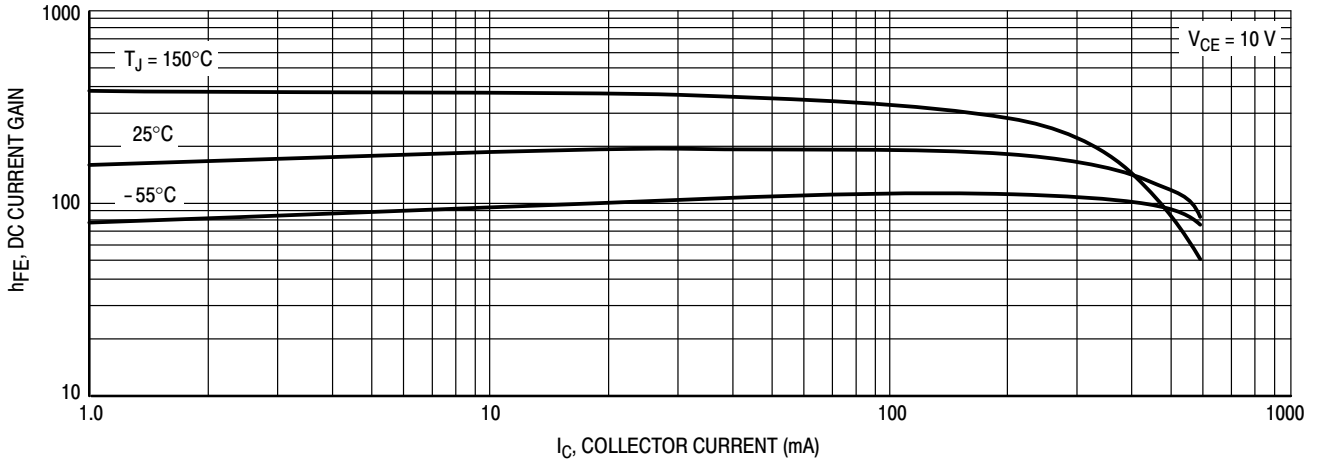

Figure 2. Storage and Fall Time Test Circuit

**LMBT2907DW1T1G, LMBT2907ADW1T1G  
S-LMBT2907DW1T1G, S-LMBT2907ADW1T1G**

**TYPICAL CHARACTERISTICS**



**Figure 3. DC Current Gain**

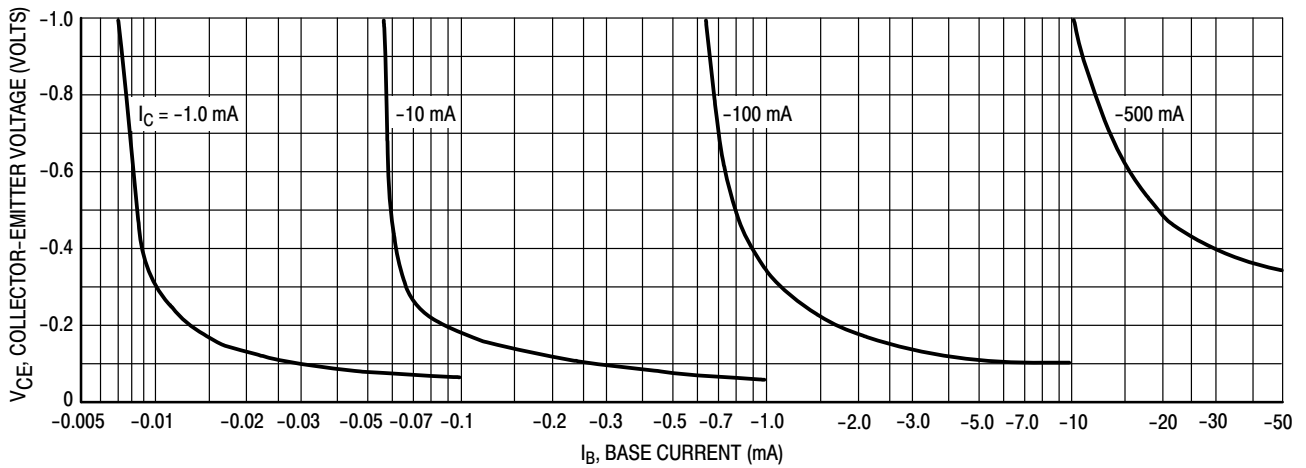

**Figure 4. Collector Saturation Region**

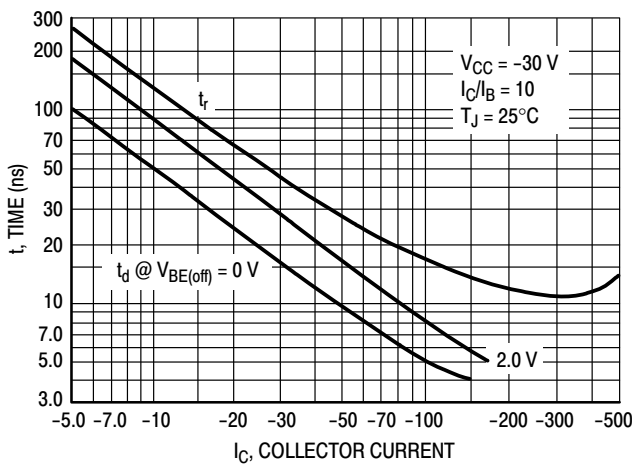

**Figure 5. Turn-On Time**

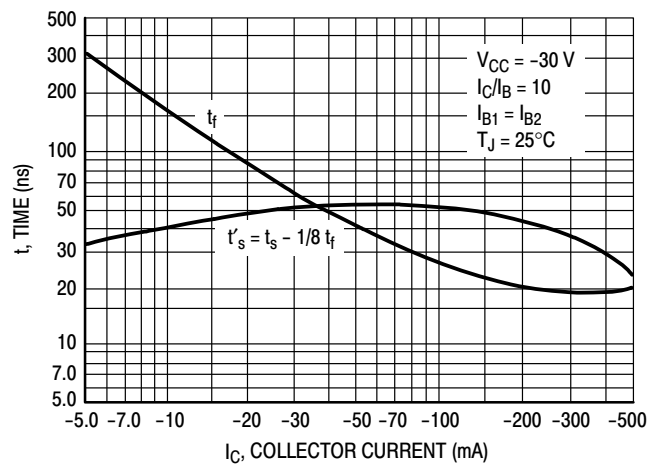

**Figure 6. Turn-Off Time**

**LMBT2907DW1T1G, LMBT2907ADW1T1G  
S-LMBT2907DW1T1G, S-LMBT2907ADW1T1G**

**TYPICAL SMALL-SIGNAL CHARACTERISTICS**

**NOISE FIGURE**

$V_{CE} = 10 \text{ Vdc}, T_A = 25^\circ\text{C}$

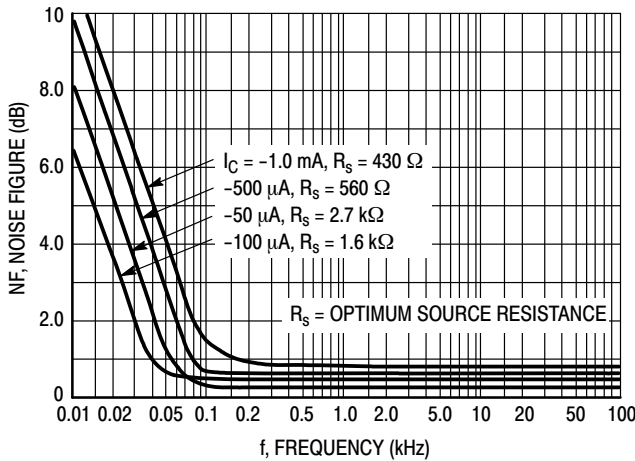

**Figure 7. Frequency Effects**

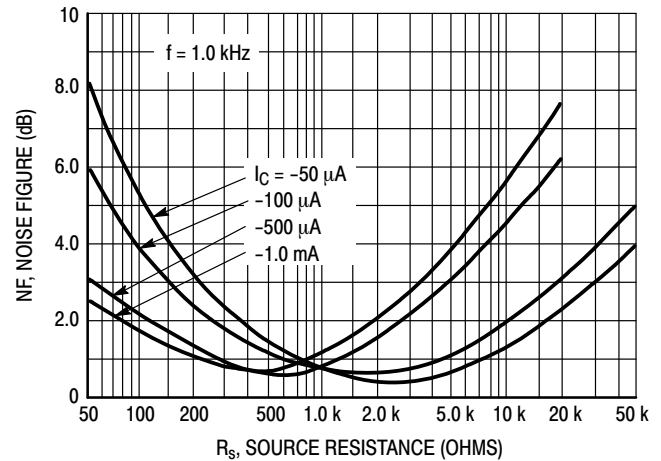

**Figure 8. Source Resistance Effects**

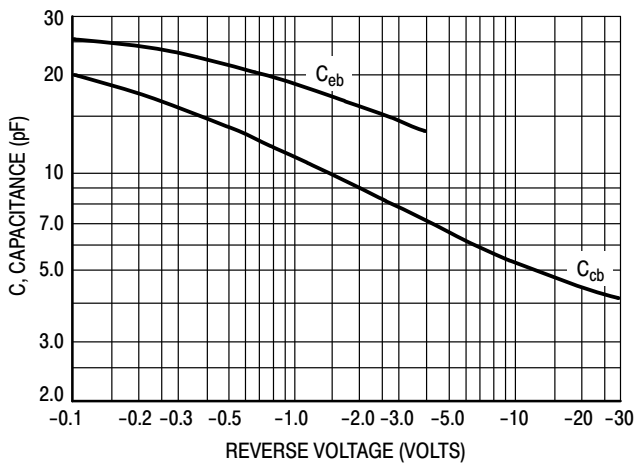

**Figure 9. Capacitances**

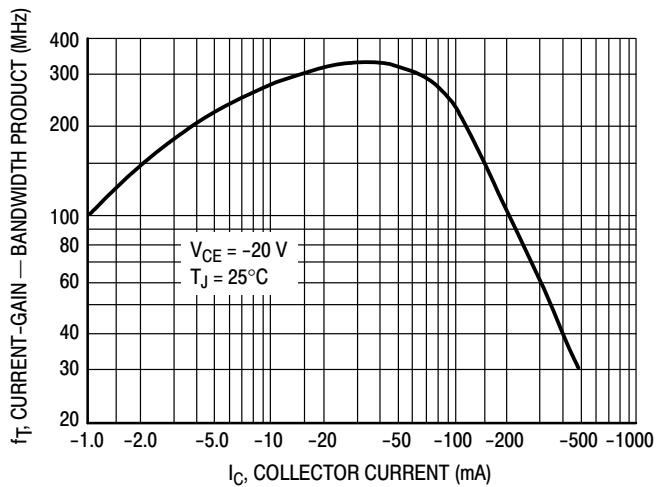

**Figure 10. Current-Gain - Bandwidth Product**

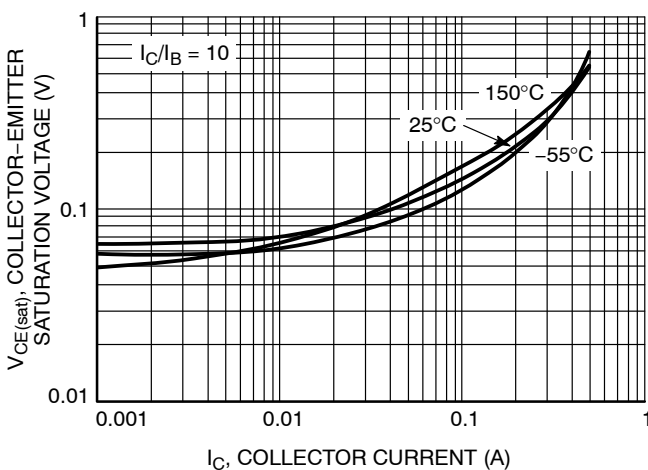

**Figure 11. Collector Emitter Saturation Voltage vs. Collector Current**

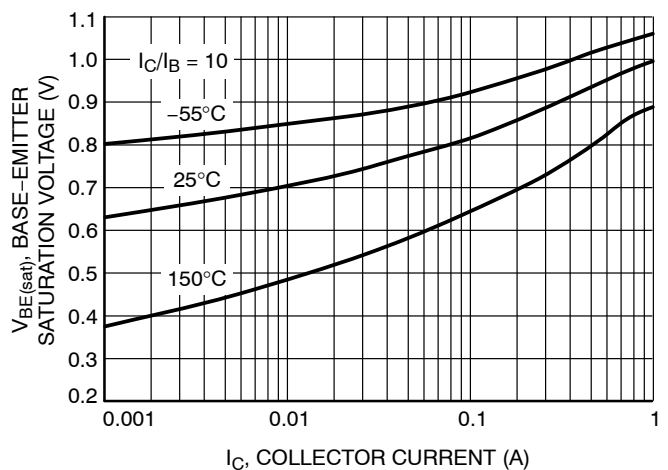
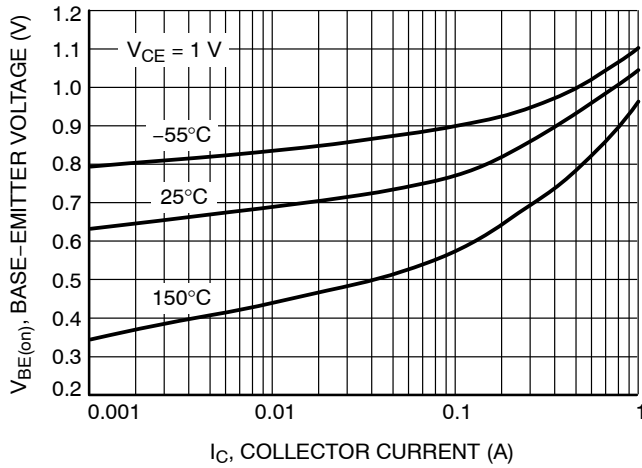

**Figure 12. Base Emitter Saturation Voltage vs. Collector Current**

**LMBT2907DW1T1G, LMBT2907ADW1T1G  
S-LMBT2907DW1T1G, S-LMBT2907ADW1T1G**

**TYPICAL SMALL-SIGNAL Characteristics  
NOISE FIGURE**

$V_{CE} = 10 \text{ Vdc}$ ,  $T_A = 25^\circ\text{C}$



**Figure 13. Base Emitter Voltage vs. Collector Current**

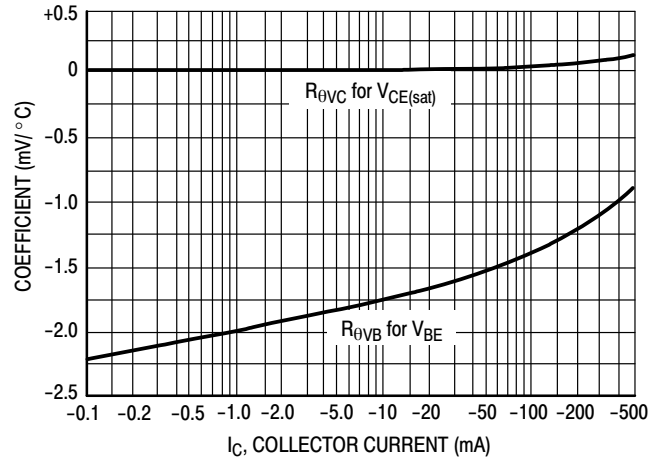

**Figure 14. Temperature Coefficients**

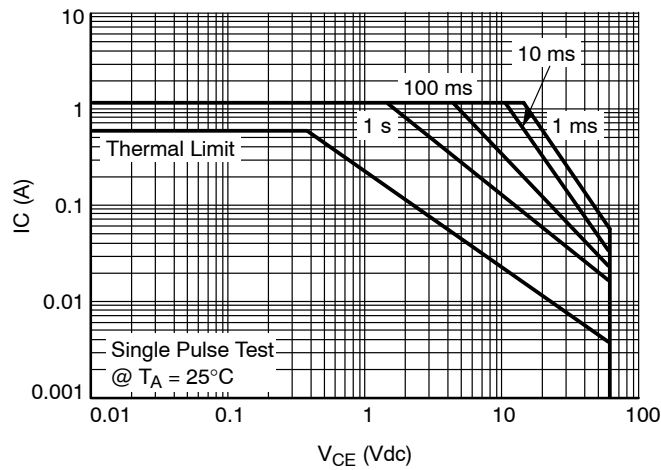

**Figure 15. Safe Operating Area**

LMBT2907DW1T1G, LMBT2907ADW1T1G  
S-LMBT2907DW1T1G, S-LMBT2907ADW1T1G

SC-88/SOT-363

NOTES:

1. DIMENSIONING AND TOLERANCING PER ANSI Y14.5M, 1982.
2. CONTROLLING DIMENSION: INCH.

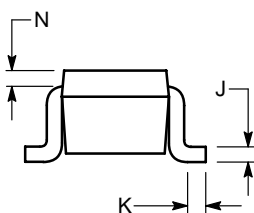
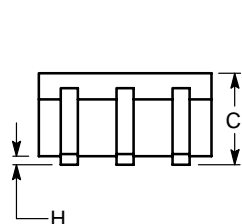
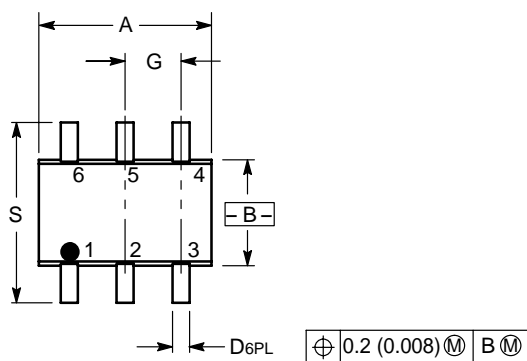

DIM	INCHES		MILLIMETERS	
	MIN	MAX	MIN	MAX
A	0.071	0.087	1.80	2.20
B	0.045	0.053	1.15	1.35
C	0.031	0.043	0.80	1.10
D	0.004	0.012	0.10	0.30
G	0.026 BSC		0.65 BSC	
H	---	0.004	---	0.10
J	0.004	0.010	0.10	0.25
K	0.004	0.012	0.10	0.30
N	0.008 REF		0.20 REF	
S	0.079	0.087	2.00	2.20

- PIN 1. EMITTER 2
- 2. BASE 2
- 3. COLLECTOR 1
- 4. EMITTER 1
- 5. BASE 1
- 6. COLLECTOR 2

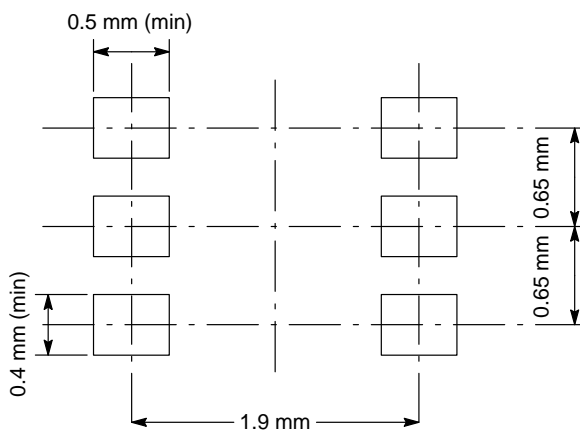

单击下面可查看定价，库存，交付和生命周期等信息

[>>LRC\(乐山无线电\)](#)