

LMBT3906N3T5G

S-LMBT3906N3T5G

General Purpose Transistors PNP Silicon

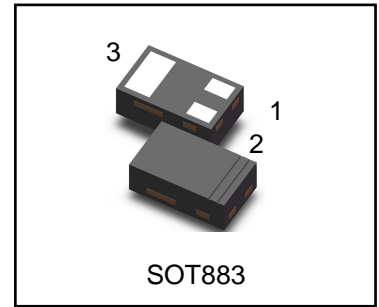

1. FEATURES

- We declare that the material of product compliance with RoHS requirements and Halogen Free.
- S- prefix for automotive and other applications requiring unique site and control change requirements; AEC-Q101 qualified and PPAP capable.

2. DEVICE MARKING AND ORDERING INFORMATION

Device	Marking	Shipping
LMBT3906N3T5G	2A	10000/Tape&Reel

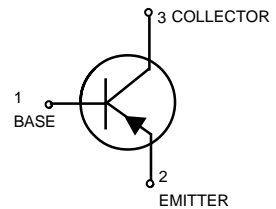

3. MAXIMUM RATINGS(Ta = 25°C)

Parameter	Symbol	Limits	Unit
Collector–Emitter Voltage	VCEO	-40	Vdc
Collector–Base Voltage	VCBO	-40	Vdc
Emitter–Base Voltage	VEBO	-5	Vdc
Collector Current — Continuous	IC	-200	mAdc

4. THERMAL CHARACTERISTICS

Parameter	Symbol	Limits	Unit
Total Device Dissipation, FR-5 Board (Note 1) @ TA = 25°C Derate above 25°C	PD	250 2	mW mW/°C
Thermal Resistance, Junction–to–Ambient	RθJA	500	°C/W
Junction and Storage temperature	TJ, Tstg	-55~+150	°C

1. FR-5 = 1.0×0.75×0.062 in.

5. ELECTRICAL CHARACTERISTICS (Ta= 25°C)
OFF CHARACTERISTICS

Characteristic	Symbol	Min.	Typ.	Max.	Unit
Collector–Emitter Breakdown Voltage (IC = -1.0 mA, IB = 0)	VBR(CEO)	-40	-	-	V
Collector–Base Breakdown Voltage (IC = -10 μA, IE = 0)	VBR(CBO)	-40	-	-	V
Emitter–Base Breakdown Voltage (IE = -10 μA, IC = 0)	VBR(EBO)	-5	-	-	V
Collector Cutoff Current (VCE = -30 V, VEB = -3.0V)	ICEX	-	-	-50	nA
Base Cutoff Current (VCE = -30 V, VEB = -3.0V)	IBL	-	-	-50	nA

ON CHARACTERISTICS (Note 2.)

DC Current Gain (IC = -0.1 mA, VCE = -1.0 V)	HFE	60	-	-	
(IC = -1.0 mA, VCE = -1.0 V)		80	-	-	
(IC = -10 mA, VCE = -1.0 V)		100	-	300	
(IC = -50 mA, VCE = -1.0 V)		60	-	-	
(IC = -100 mA, VCE = -1.0 V)		30	-	-	
Collector–Emitter Saturation Voltage (IC = -10 mA, IB = -1.0 mA)	VCE(sat)	-	-	-0.25	V
(IC = -50 mA, IB = -5.0 mA)		-	-	-0.4	
Base–Emitter Saturation Voltage (IC = -10 mA, IB = -1.0 mA)	VBE(sat)	-0.65	-	-0.85	V
(IC = -50 mA, IB = -5.0 mA)		-	-	-0.95	

SMALL–SIGNAL CHARACTERISTICS

Current–Gain — Bandwidth Product (IC = -10mA, VCE= -20V, f = 100MHz)	fT	250	-	-	MHz
Output Capacitance (VCB = -5.0 V, IE = 0, f = 1.0 MHz)	Cobo	-	-	4.5	pF
Input Capacitance (VEB = -0.5 V, IC = 0, f = 1.0 MHz)	Cibo	-	-	10	pF

SWITCHING CHARACTERISTICS

Delay Time	(VCC = -3.0 V, VBE=0.5V, IC = -10mA, IB1 = -1.0 mA)	td	-	-	35	ns
Rise Time		tr	-	-	35	
Storage Time		ts	-	-	225	
Fall Time		tf	-	-	75	

 2.Pulse Test: Pulse Width $\leq 300 \mu\text{s}$, Duty Cycle $\leq 2.0\%$.

6.ELECTRICAL CHARACTERISTICS CURVES

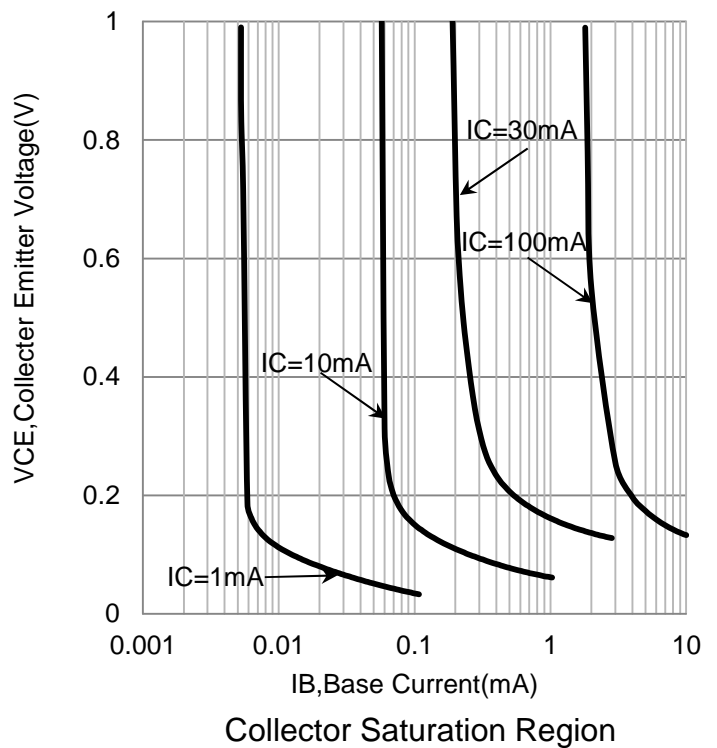
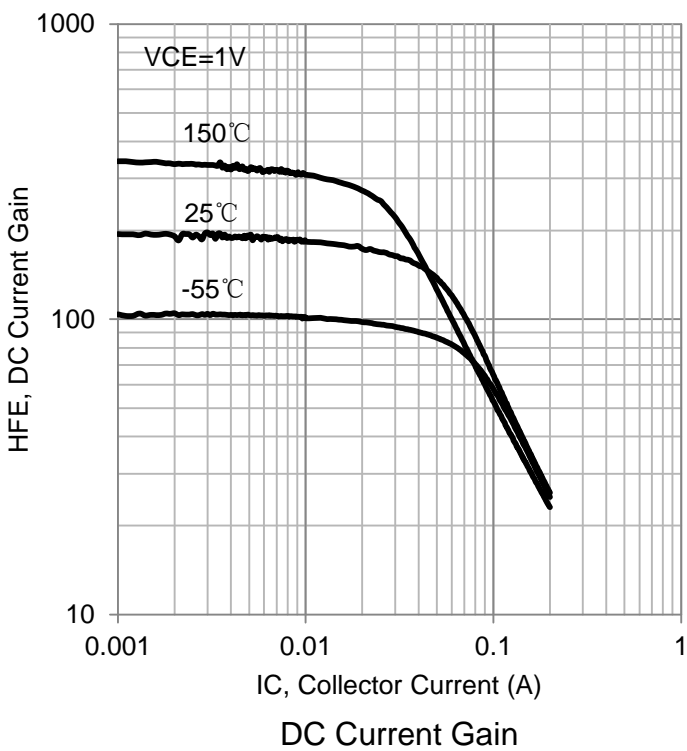
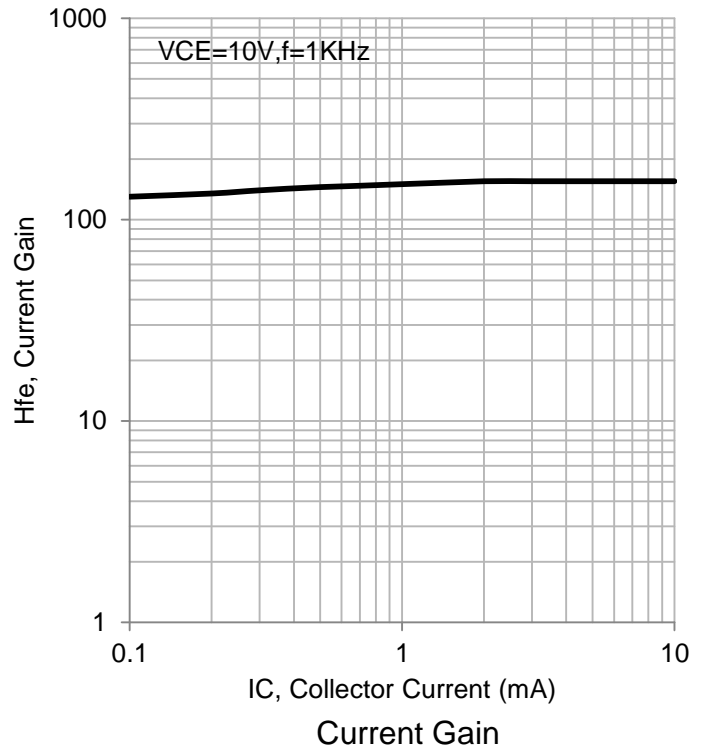
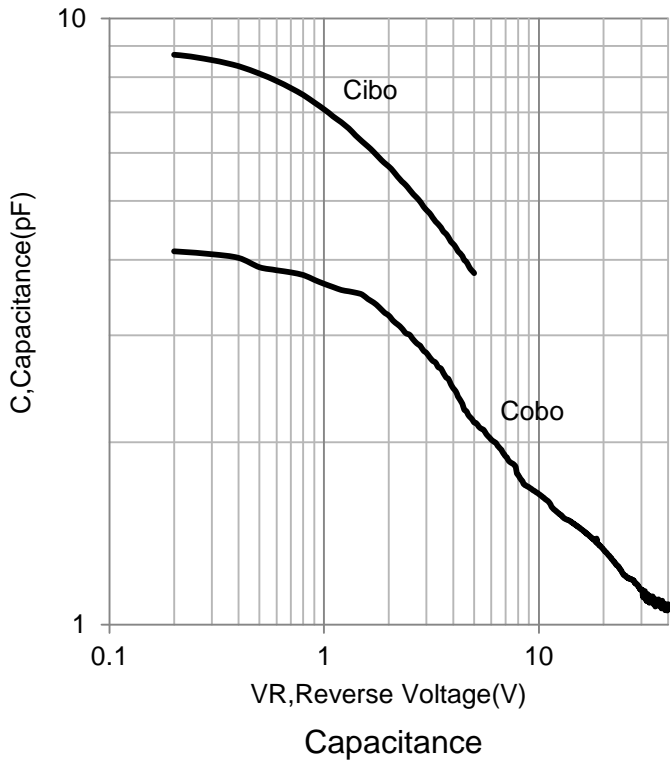

6.ELECTRICAL CHARACTERISTICS CURVES(Con.)

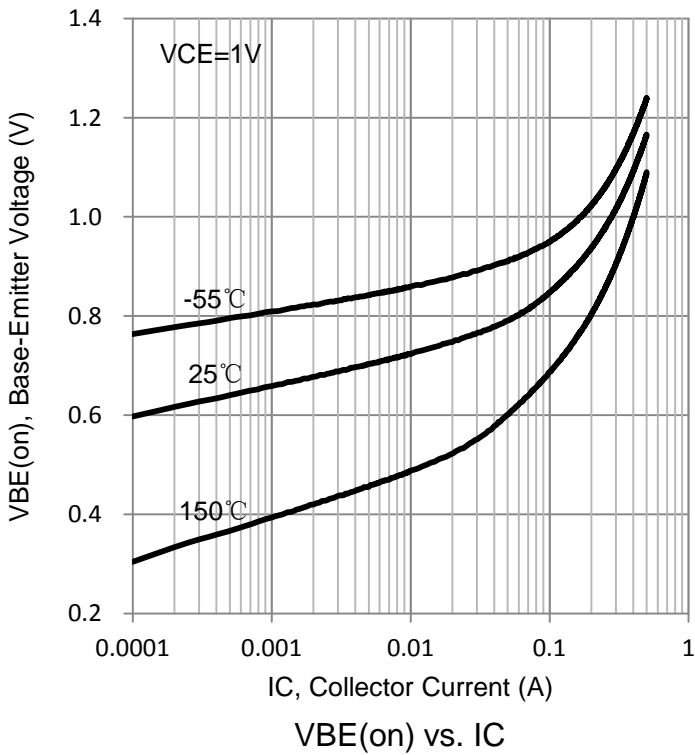
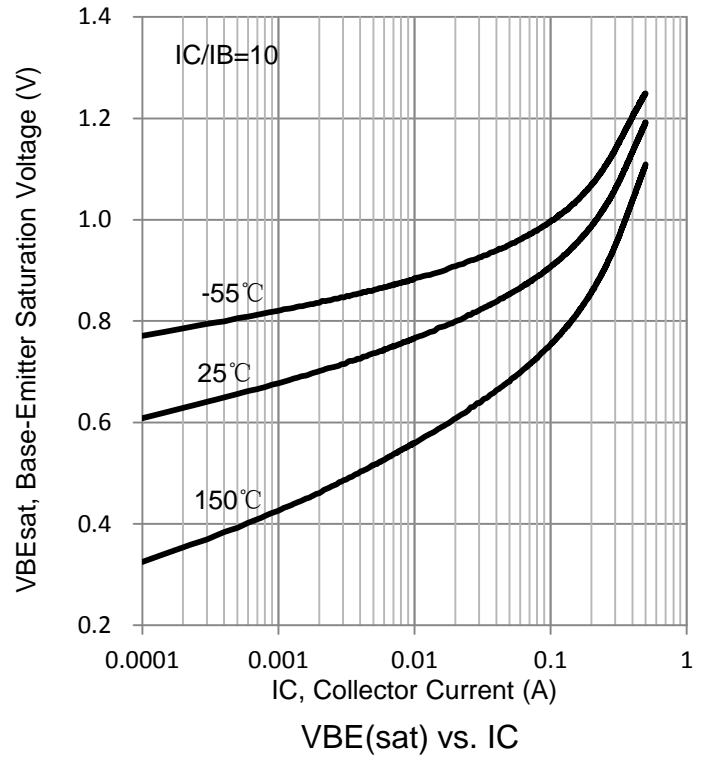
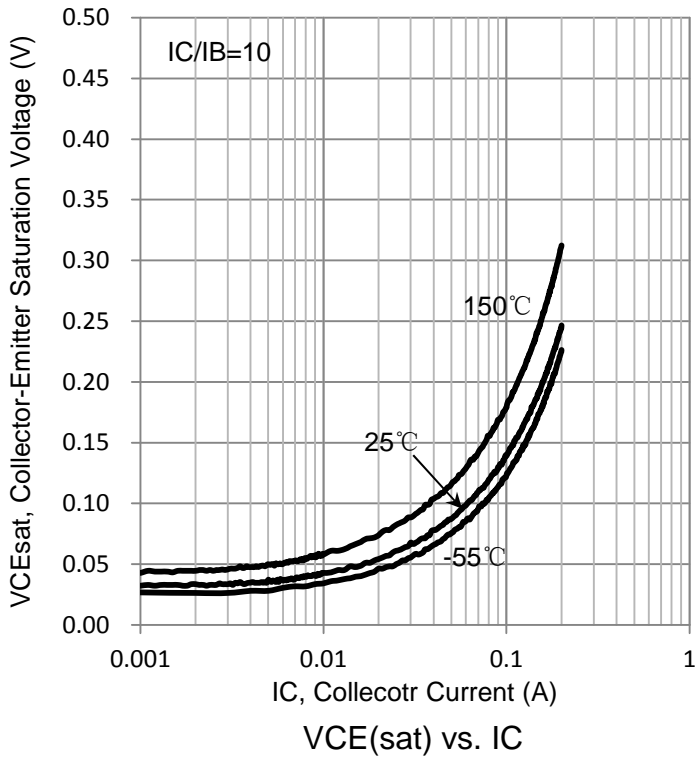

7. OUTLINE AND DIMENSIONS

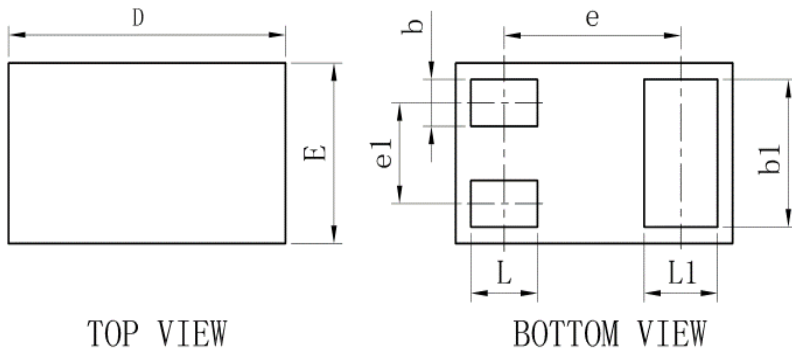

TOP VIEW

BOTTOM VIEW

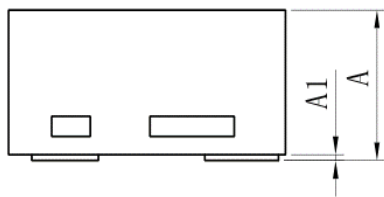

SIDE VIEW

SOT883			
DIM	MIN	TYP	MAX
D	0.95	1.00	1.05
E	0.55	0.60	0.65
e	-	0.64	-
e1	-	0.34	-
L	0.19	0.24	0.29
L1	0.22	0.27	0.32
b	0.10	0.15	0.20
b1	0.44	0.49	0.54
A	0.43	0.48	0.53
A1	0	-	0.05
All Dimensions in mm			

8. SOLDERING FOOTPRINT

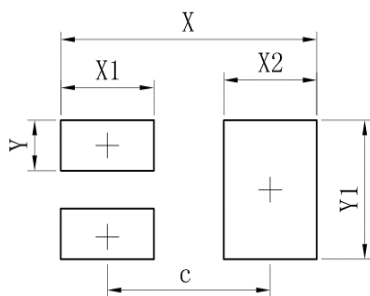

Dimensions	(mm)
c	0.70
X	1.10
X1	0.40
X2	0.40
Y	0.20
Y1	0.55

单击下面可查看定价，库存，交付和生命周期等信息

[>>LRC\(乐山无线电\)](#)