

Darlington Transistors

NPN Silicon

- We declare that the material of product compliance with RoHS requirements.
- S- Prefix for Automotive and Other Applications Requiring Unique Site and Control Change Requirements; AEC-Q101 Qualified and PPAP Capable.

Ordering Information

Device	Marking	Shipping
LMBT6427LT1G S-LMBT6427LT1G	1V	3000/Tape&Reel
LMBT6427LT3G S-LMBT6427LT3G	1V	10000/Tape&Reel

MAXIMUM RATINGS

Rating	Symbol	Value	Unit
Collector–Emitter Voltage	V_{CEO}	40	Vdc
Collector–Base Voltage	V_{CBO}	40	Vdc
Emitter–Base Voltage	V_{EBO}	12	Vdc
Collector Current — Continuous	I_C	500	mAdc

THERMAL CHARACTERISTICS

Characteristic	Symbol	Max	Unit
Total Device Dissipation FR–5 Board, (1) $T_A = 25^\circ\text{C}$	P_D	225	mW
Derate above 25°C		1.8	mW/ $^\circ\text{C}$
Thermal Resistance, Junction to Ambient	$R_{\theta JA}$	556	$^\circ\text{C}/\text{W}$
Total Device Dissipation Alumina Substrate, (2) $T_A = 25^\circ\text{C}$	P_D	300	mW
Derate above 25°C		2.4	mW/ $^\circ\text{C}$
Thermal Resistance, Junction to Ambient	$R_{\theta JA}$	417	$^\circ\text{C}/\text{W}$
Junction and Storage Temperature	T_J, T_{stg}	–55 to +150	$^\circ\text{C}$

DEVICE MARKING

(S-)LMBT6427LT1G = 1V

ELECTRICAL CHARACTERISTICS ($T_A = 25^\circ\text{C}$ unless otherwise noted.)

Characteristic	Symbol	Min	Max	Unit
----------------	--------	-----	-----	------

OFF CHARACTERISTICS

Collector–Emitter Breakdown Voltage(3) ($I_C = 10 \text{ mAdc}, V_{BE} = 0$)	$V_{(BR)CEO}$	40	—	Vdc
Collector–Base Breakdown Voltage ($I_C = 100 \mu\text{Adc}, I_E = 0$)	$V_{(BR)CBO}$	40	—	Vdc
Emitter–Base Breakdown Voltage ($I_E = 10 \mu\text{Adc}, I_C = 0$)	$V_{(BR)EBO}$	12	—	Vdc
Collector Cutoff Current ($V_{CE} = 25\text{Vdc}, I_B = 0$)	I_{CES}	—	1.0	μAdc
Collector Cutoff Current ($V_{CB} = 30\text{Vdc}, I_E = 0$)	I_{CBO}	—	50	nAdc
Emitter Cutoff Current ($V_{EB} = 10\text{Vdc}, I_C = 0$)	I_{EBO}	—	50	nAdc

1. FR–5 = 1.0 x 0.75 x 0.062 in.

2. Alumina = 0.4 x 0.3 x 0.024 in. 99.5% alumina.

LMBT6427LT1G
S-LMBT6427LT1G

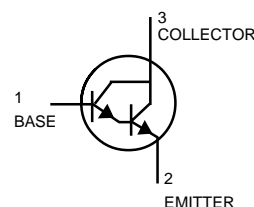
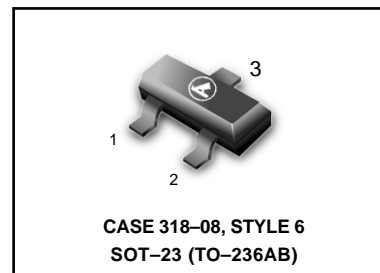

LMBT6427LT1G , S-LMBT6427LT1G

ELECTRICAL CHARACTERISTICS ($T_A = 25^\circ\text{C}$ unless otherwise noted) (Continued)

Characteristic	Symbol	Min	Max	Unit
----------------	--------	-----	-----	------

ON CHARACTERISTICS

DC Current Gain ($I_C = 10 \text{ mAdc}, V_{CE} = 5.0 \text{ Vdc}$) ($I_C = 100 \text{ mAdc}, V_{CE} = 5.0 \text{ Vdc}$) ($I_C = 500 \text{ mAdc}, V_{CE} = 5.0 \text{ Vdc}$)	h_{FE}	10,000 20,000 14,000	100,000 200,000 140,000	—
Collector–Emitter Saturation Voltage ($I_C = 50 \text{ mAdc}, I_B = 0.5 \text{ mAdc}$) ($I_C = 500 \text{ mAdc}, I_B = 0.5 \text{ mAdc}$)	$V_{CE(sat)}(3)$	— —	1.2 1.5	Vdc
Base–Emitter Saturation Voltage ($I_C = 500 \text{ mAdc}, I_B = 0.5 \text{ mAdc}$)	$V_{BE(sat)}$	—	2.0	Vdc
Base–Emitter On Voltage ($I_C = 50 \text{ mAdc}, V_{CE} = 5.0 \text{ Vdc}$)	$V_{BE(on)}$	—	1.75	Vdc

SMALL–SIGNAL CHARACTERISTICS

Output Capacitance ($V_{CB} = 10 \text{ Vdc}, I_E = 0, f = 1.0 \text{ MHz}$)	C_{obo}	—	7.0	pF
Input Capacitance ($V_{EB} = 0.5 \text{ Vdc}, I_C = 0, f = 1.0 \text{ MHz}$)	C_{ibo}	—	15	pF
Current Gain–High Frequency ($V_{CE} = 5.0 \text{ Vdc}, I_C = 10 \text{ mAdc}, f = 100 \text{ MHz}$)	$ h_{fe} $	1.3	—	Vdc
Noise Finure ($V_{CE} = 5.0 \text{ Vdc}, I_C = 1.0 \text{ mAdc}, R_S = 100 \text{ k}\Omega, f = 1.0 \text{ kHz}$)	NF	—	10	dB

3. **Pulse Tent:** Pulse Width = 300 μs , Duty Cycle = 2.0%

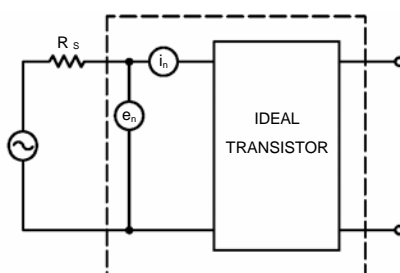

Figure 1. Transistor Noise Model

LMBT6427LT1G , S-LMBT6427LT1G

NOISE CHARACTERISTICS

($V_{CE} = 5.0 \text{ Vdc}$, $T_A = 25^\circ\text{C}$)

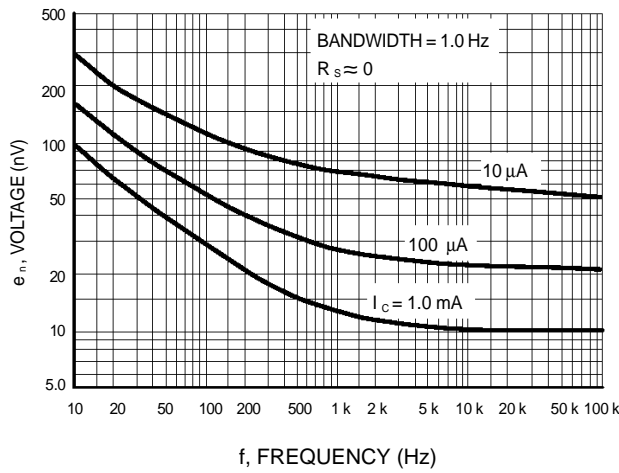

Figure 2. Noise Voltage

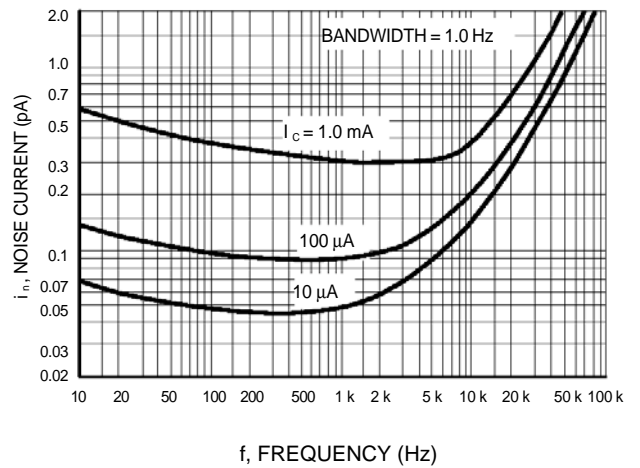

Figure 3. Noise Current

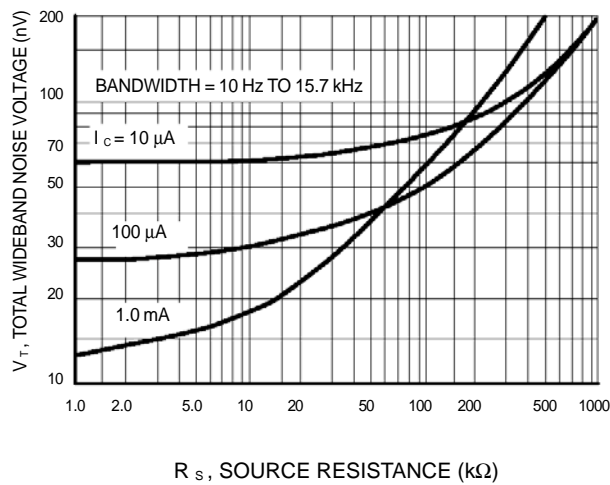

Figure 4. Total Wideband Noise Voltage

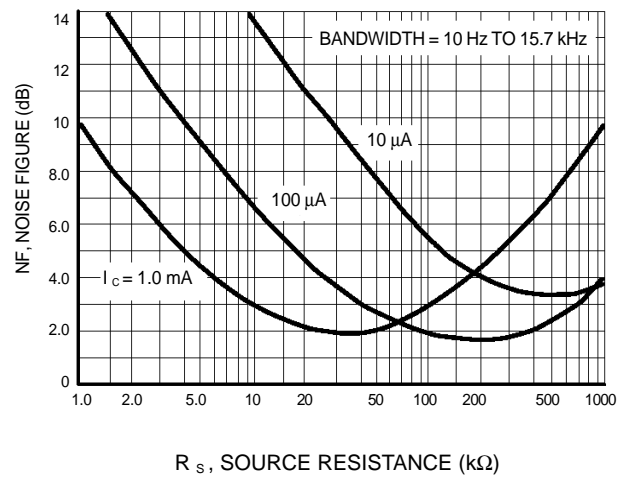

Figure 5. Wideband Noise Figure

LMBT6427LT1G , S-LMBT6427LT1G

SMALL-SIGNAL CHARACTERISTICS

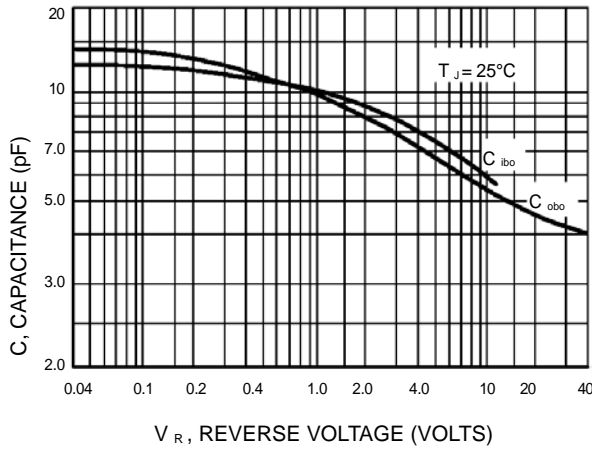

Figure 6. Capacitance

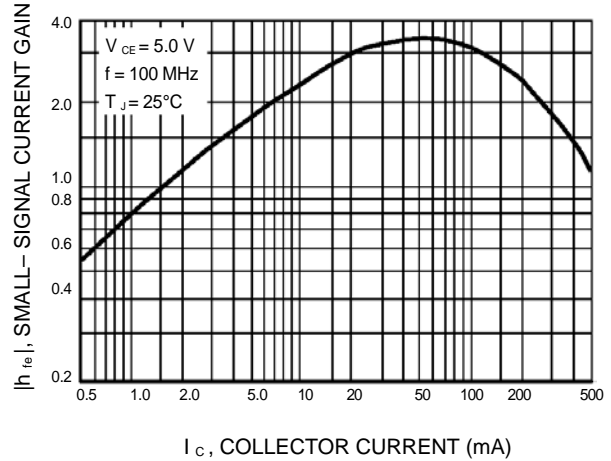

Figure 7. High Frequency Current Gain

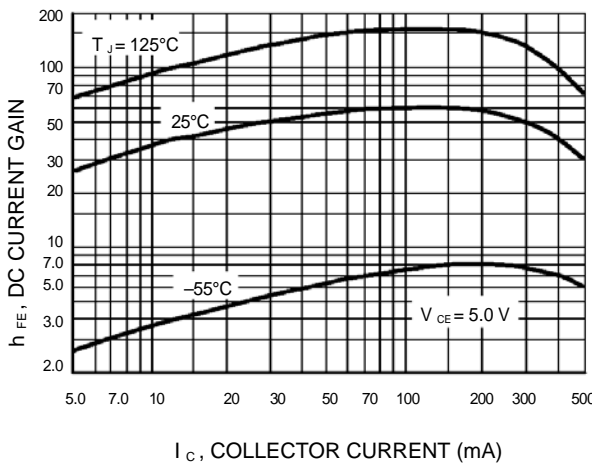

Figure 8. DC Current Gain

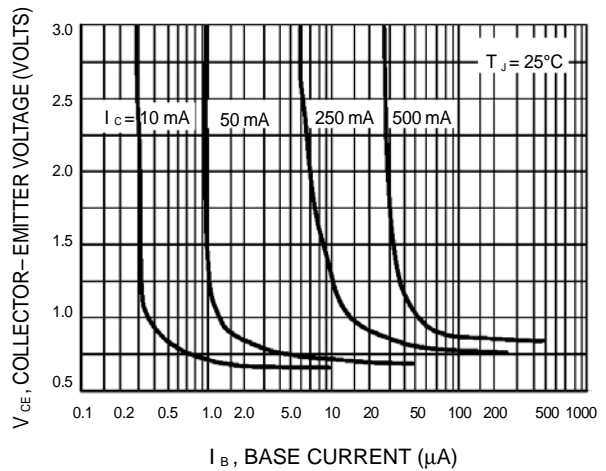

Figure 9. Collector Saturation Region

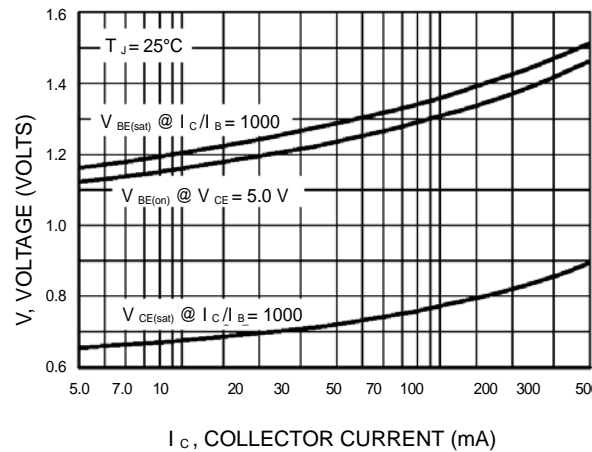

Figure 10. "On" Voltages

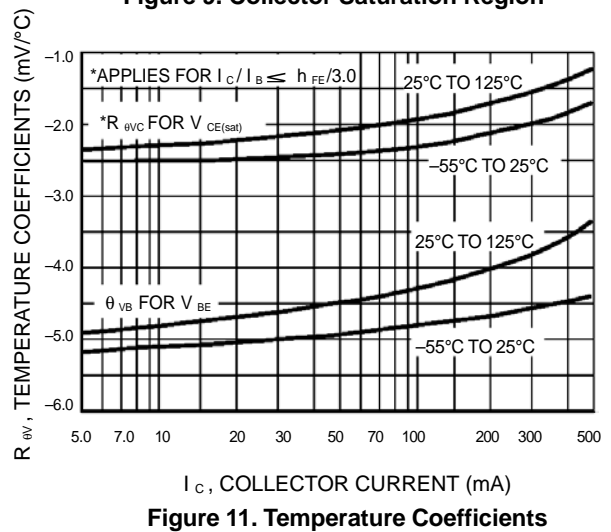

Figure 11. Temperature Coefficients

LMBT6427LT1G , S-LMBT6427LT1G

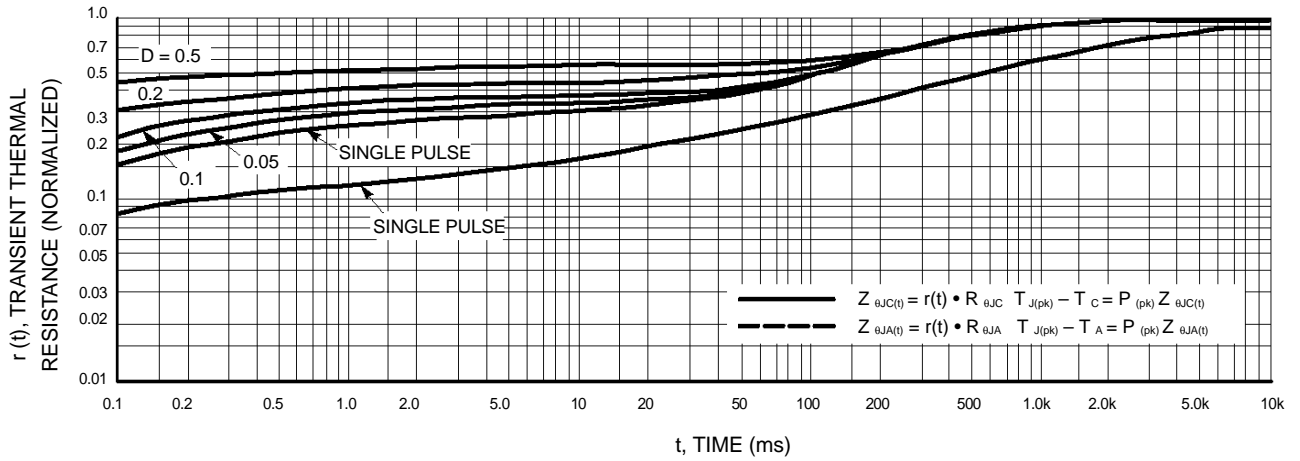
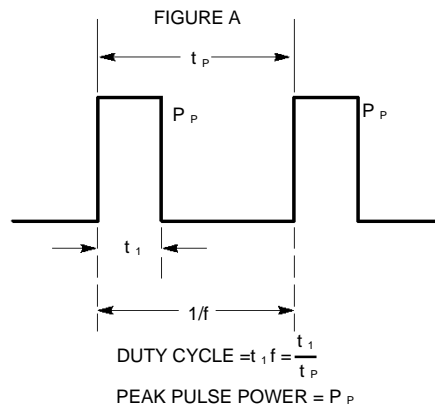

Figure 12. Thermal Response



Design Note: Use of Transient Thermal Resistance Data

LMBT6427LT1G , S-LMBT6427LT1G

SOT-23

NOTES:

1. DIMENSIONING AND TOLERANCING PER ANSI Y14.5M,1982
2. CONTROLLING DIMENSION: INCH.

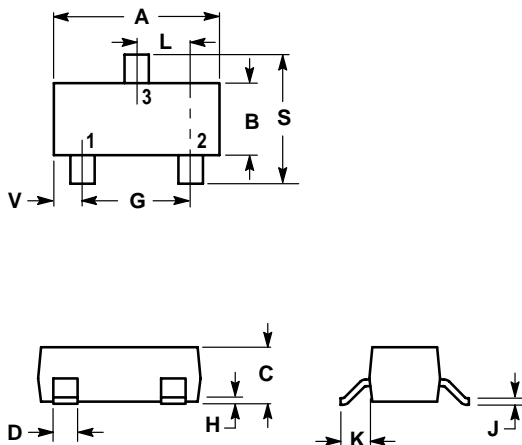

DIM	INCHES		MILLIMETERS	
	MIN	MAX	MIN	MAX
A	0.1102	0.1197	2.80	3.04
B	0.0472	0.0551	1.20	1.40
C	0.0350	0.0440	0.89	1.11
D	0.0150	0.0200	0.37	0.50
G	0.0701	0.0807	1.78	2.04
H	0.0005	0.0040	0.013	0.100
J	0.0034	0.0070	0.085	0.177
K	0.0140	0.0285	0.35	0.69
L	0.0350	0.0401	0.89	1.02
S	0.0830	0.1039	2.10	2.64
V	0.0177	0.0236	0.45	0.60

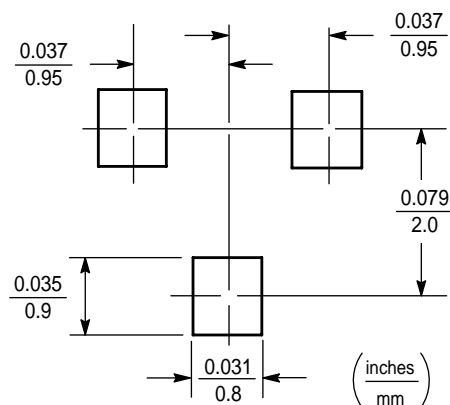

单击下面可查看定价，库存，交付和生命周期等信息

[>>LRC\(乐山无线电\)](#)