

LP4407T1G

P-Channel 30-V (D-S) MOSFET

1. FEATURES

- Low RDS(on) trench technology.
- Low thermal impedance.
- Fast switching speed.
- We declare that the material of product are Halogen Free and compliance with RoHS requirements.
- ESD protected

2. APPLICATION

- Load Switches
- DC/DC Conversion
- Motor Drives

3. ORDERING INFORMATION

Device	Marking	Shipping
LP4407T1G	LP4407	4000/Tape&Reel

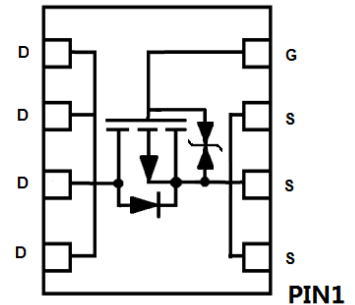
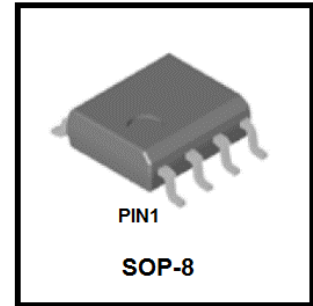

4. MAXIMUM RATINGS(Ta = 25°C unless otherwise stated)

Parameter	Symbol	Limits	Unit
Drain-to-Source Voltage	VDSS	-30	V
Gate-to-Source Voltage	VGS	±25	V
Avalanche Current	IAS	40	A
Avalanche energy L=0.1mH	EAS	80	mJ
Continuous Drain Current(Note 1)	ID	TA =25°C	-18
		TA =70°C	-13
Pulsed Drain Current (Note 2)	IDM	-50	A
Power Dissipation(Note 1)	PD	TA =25°C	3.1
		TA =70°C	2
Operating Junction Temperature	TJ	-55 ~+150	°C
Storage Temperature Range	Tstg	-55 ~+150	

- 1.Surface Mounted on 1" x 1" FR4 Board.
- 2.Pulse width limited by maximum junction temperature.

5. THERMAL CHARACTERISTICS

Parameter	Symbol	Max	Unit
Maximum Junction-to-Ambient (Note 1)	RθJA	t ≤ 10S	40
		Steady State	90

6. ELECTRICAL CHARACTERISTICS

Characteristic	Symbol	Min.	Typ.	Max.	Unit
Static					
Drain-Source Breakdown Voltage (VGS=0 , ID = -250 uA)	V(BR)DSS	-30			V
Gate-Source Threshold Voltage (VDS = VGS , ID = -250 uA)	VGS(th)	-1	-1.3	-3	V
Gate-Body Leakage (VDS = 0 V, VGS = ±25 V)	IGSS	-	-	±10	μA
Zero Gate Voltage Drain Current (VDS = -24 V, VGS = 0 V) (VDS = -24 V, VGS = 0 V, TJ = 55° C)	IDSS	-	-	-1 -25	μA
Drain-Source On-Resistance(Note 3) (VGS = -10 V, ID = -13.6 A) (VGS = -4.5 V, ID = -10.9 A)	RDS(on)	-	7.5 10.5	9 13	mΩ
Diode Forward Voltage(Note 3) (IS = -2.3 A, VGS = 0 V)	VSD	-	-0.76	-1.2	V
Dynamic(Note 4)					
Total Gate Charge	(VDS = -15 V, VGS = -4.5 V, ID = -13.6 A)	Qg	-	35	nC
Gate-Source Charge		Qgs	-	11.5	
Gate-Drain Charge		Qgd	-	9	
Input Capacitance	(VDS = -15 V, VGS = 0 V, f = 1 MHz)	Ciss	-	4383	pF
Output Capacitance		Coss	-	432	
Reverse Transfer Capacitance		Crss	-	364	
Turn-On Delay Time	(VDS=-15 V, RL=1.2 Ω, ID=- 13.6 A, VGEN=-10 V, RGEN=6 Ω)	td(on)	-	14	ns
Rise Time		tr	-	37	
Turn-Off Delay Time		td(off)	-	124	
Fall Time		tf	-	55	
Source-Drain Diodes Ratings and Characteristics(TC= 25° C)					
Continuous Current(Note 1)	IS			-25	A
Plused Current(Note 1)	ISM			-100	A
Reverse Recovery Time (IF=IS,dIf/dt=100A/us)	trr		62		ns
Reverse Recovery Charge (IF=IS,dIf/dt=100A/us)	Qrr		68		nC

3.Pulse test: PW ≤ 300μs duty cycle ≤ 2%.

4.Guaranteed by design, not subject to production testing.

7. ELECTRICAL CHARACTERISTICS CURVES

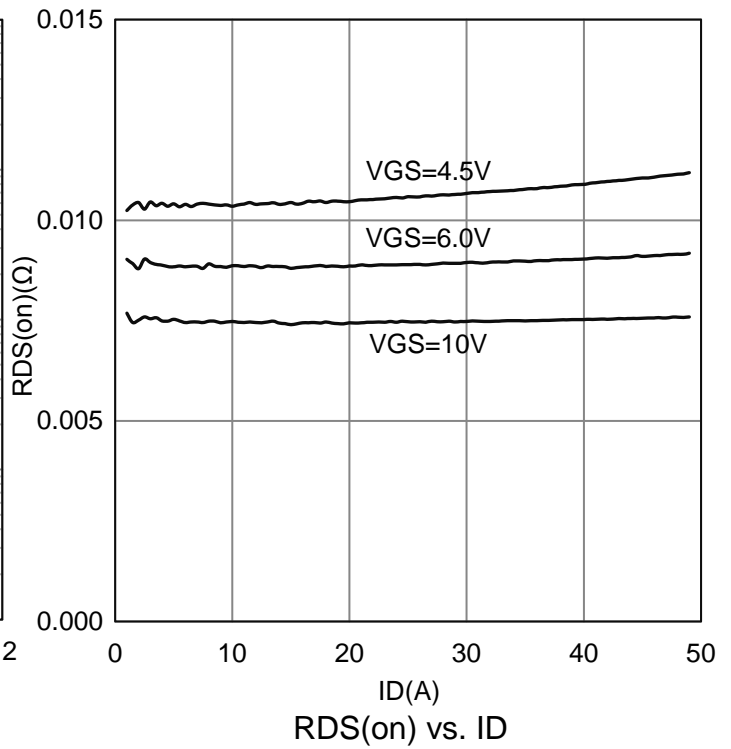
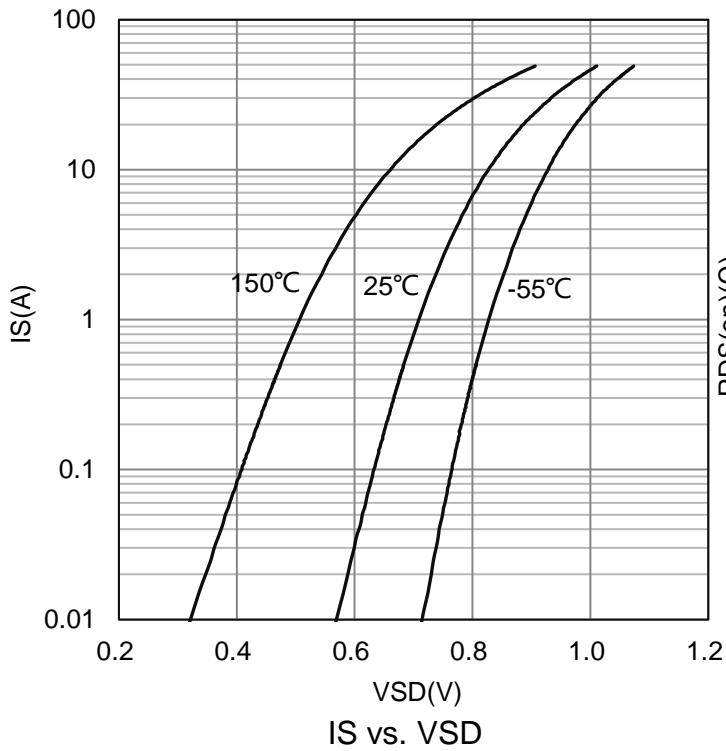
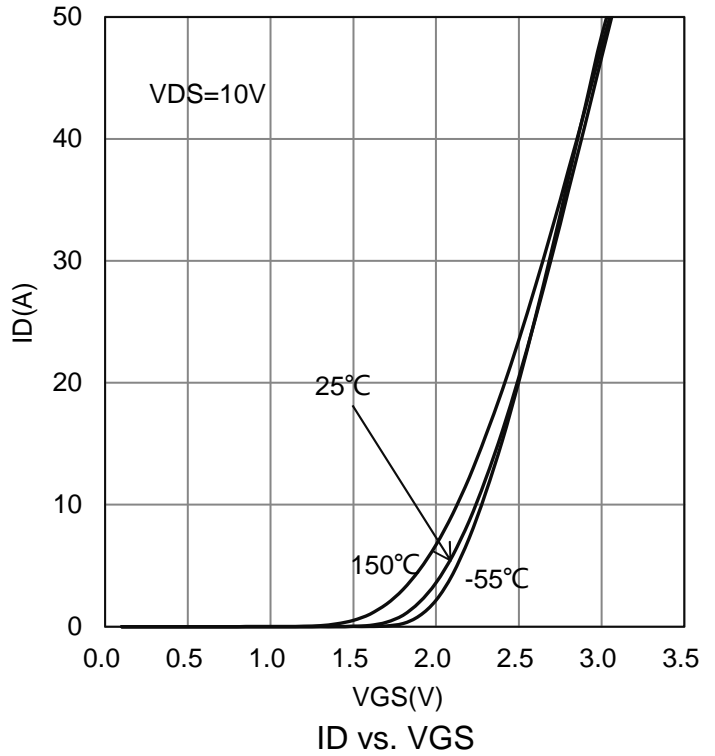
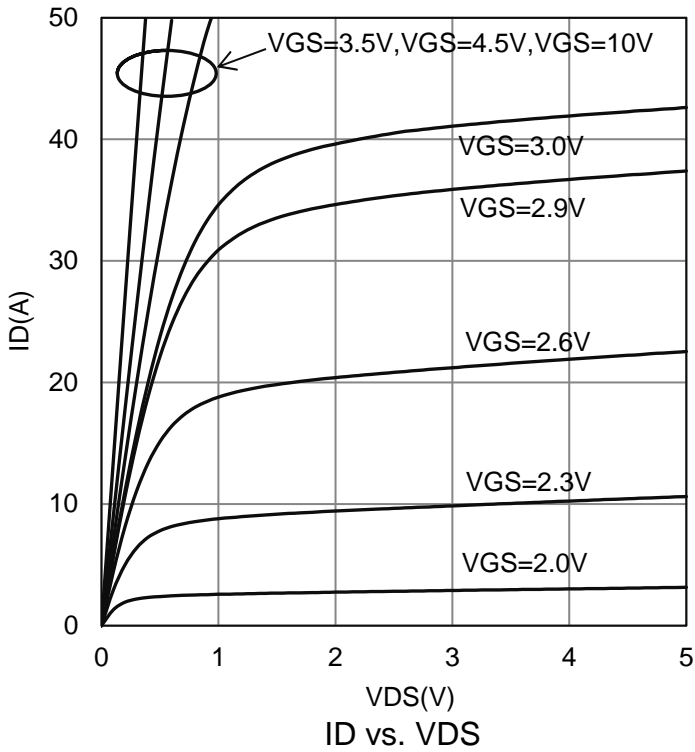

7. ELECTRICAL CHARACTERISTICS CURVES(Con.)

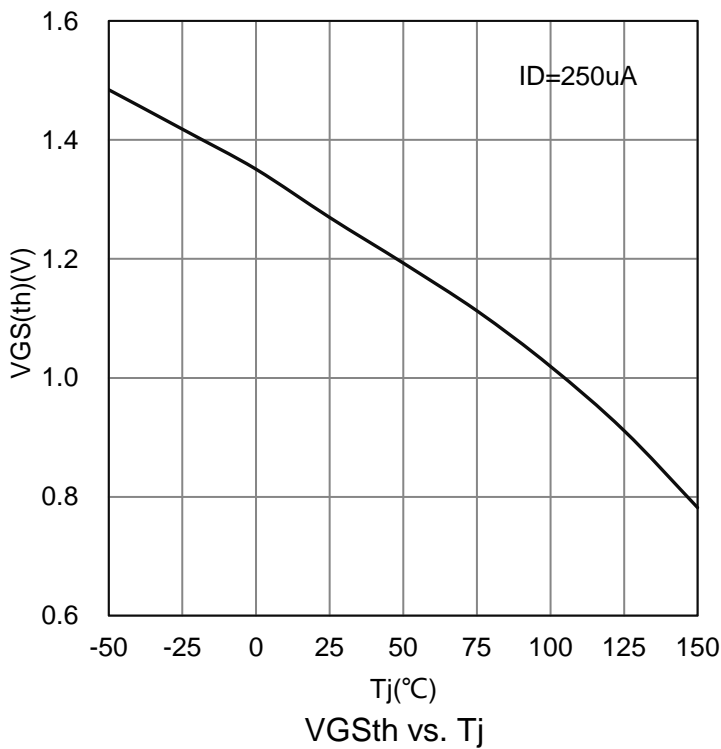
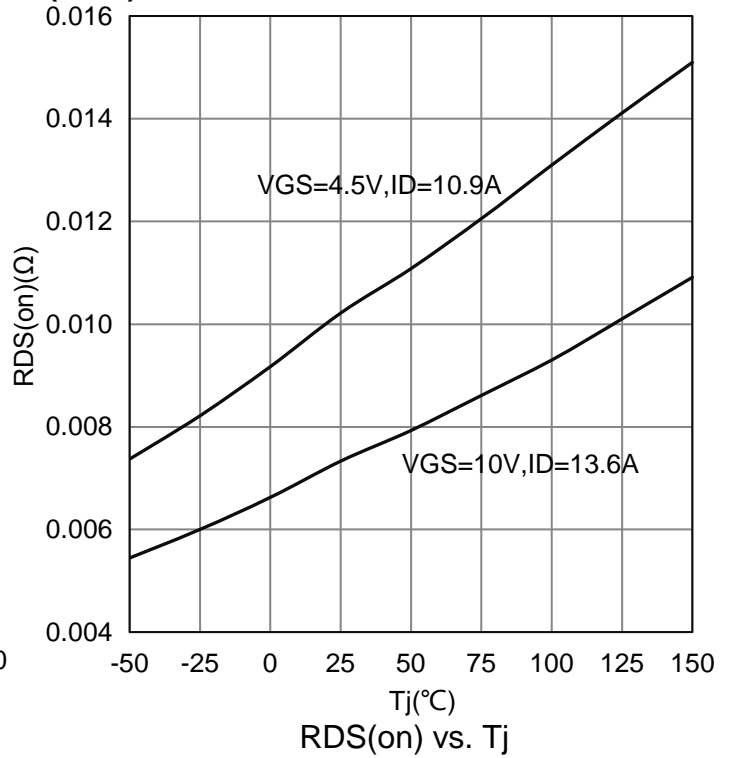
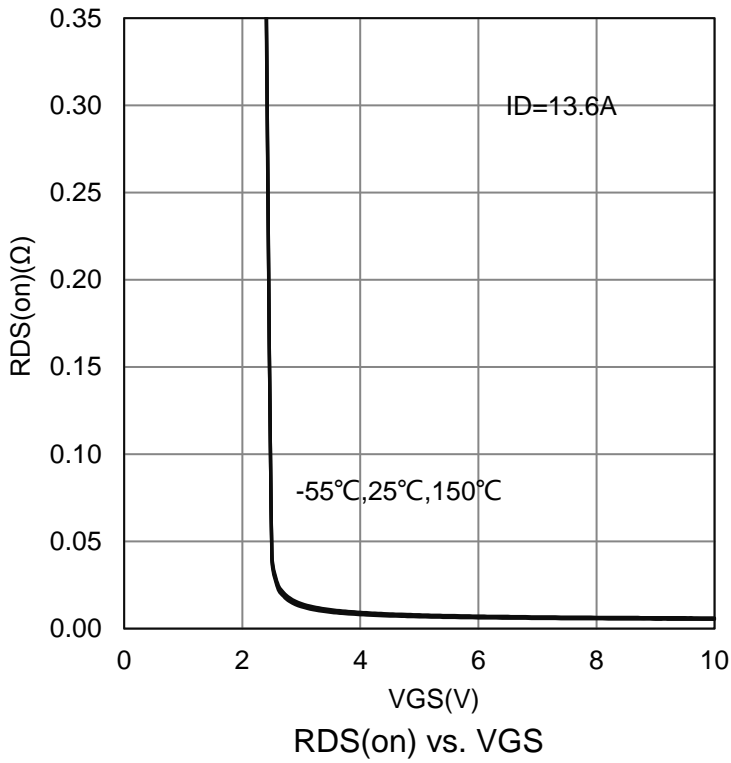

OUTLINE AND DIMENSIONS

SOP8

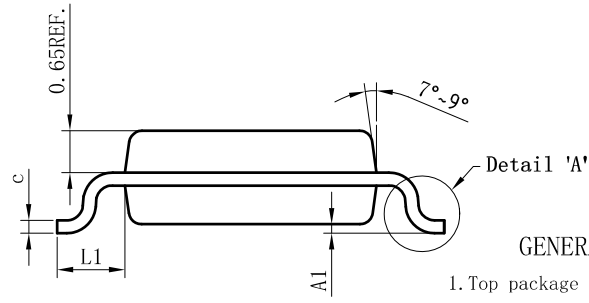
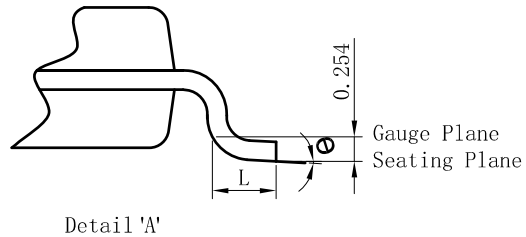
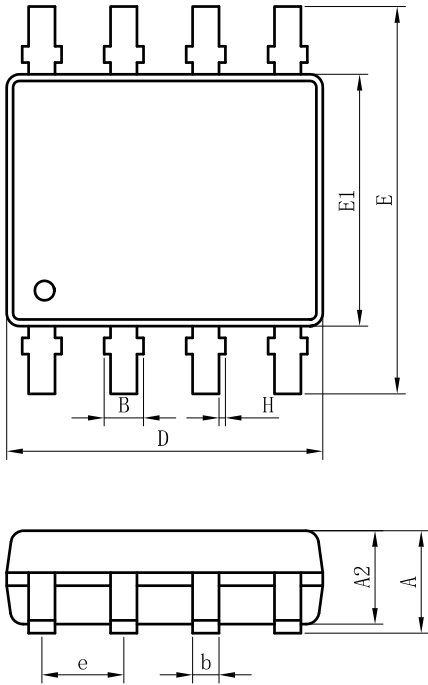

SOP8			
DIM	MIN	NOR	MAX
A	-	-	1.75
A1	0.10	0.15	0.20
A2	1.35	1.45	1.55
b	0.33	0.42	0.51
c	0.15	0.22	0.29
D	4.77	4.90	5.03
E	5.80	6.00	6.20
E1	3.80	3.90	4.00
e	1.27BSC		
L	0.46	0.66	0.86
L1	0.85	1.05	1.25
θ	0°	5°	8°
B	-	-	0.55
H	0	0.05	0.10
All Dimensions in mm			

GENERAL NOTES

1. Top package surface finish Ra0.4±0.2um
2. Bottom package surface finish Ra0.7±0.2um
3. Side package surface finish Ra0.4±0.2um
4. Package Body Sizes Exclude Mold Flash, Protrusion Or Gate Burrs. Mold Flash, Protrusion Or Gate Burrs Shall Not Exceed 0.10 mm Per Side.
5. Dimension "b" Does Not Include Dambar Protrusion.

SOLDERING FOOTPRINT

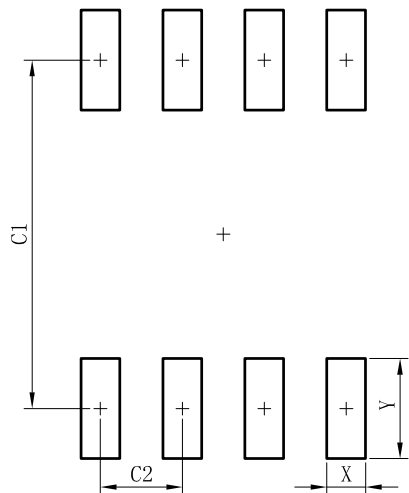

SOP8	
DIM	(mm)
X	0.60
Y	1.55
C1	5.40
C2	1.27

单击下面可查看定价，库存，交付和生命周期等信息

[>>LRC\(乐山无线电\)](#)