

# L1SS400T1G

# S-L1SS400T1G

## Switching Diode

### 1. FEATURES

- We declare that the material of product compliance with RoHS requirements and Halogen Free.
- S- prefix for automotive and other applications requiring unique site and control change requirements; AEC-Q101 qualified and PPAP capable.
- Extremely small surface mounting type.
- High Speed.
- High reliability.

### 2. APPLICATIONS

- High speed switching.

### 3. DEVICE MARKING AND ORDERING INFORMATION

Device	Marking	Shipping
L1SS400T1G	A	3000/Tape&Reel
L1SS400T5G	A	8000/Tape&Reel

### 4. MAXIMUM RATINGS (Ta = 25°C)

Parameter	Symbol	Limit	Unit
Peak reverse voltage	VRM	100	V
DC reverse voltage	VR	100	V
Peak forward surge current (8.3ms half sine-wave)	IFSM	1.5	A
Mean rectifying current	IO	200	mA
Surge current (1s)	Is	500	mA
Junction temperature	Tj	150	°C
Storage temperature	Tstg	-55~+150	°C

### 5. THERMAL CHARACTERISTICS

Parameter	Symbol	Limits	Unit
Total Device Dissipation, FR-5 Board (Note 1) @ TA = 25°C Derate above 25°C	PD	200 1.6	mW mW/°C
Thermal Resistance, Junction-to-Ambient(Note 1)	RθJA	625	°C/W

1. FR-5 = 1.0×0.75×0.062 in.

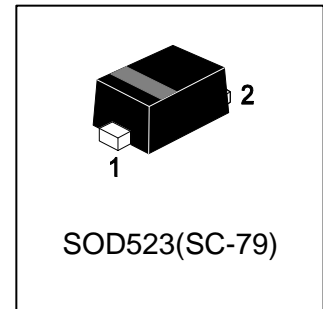

**6. ELECTRICAL CHARACTERISTICS (T<sub>j</sub> =25°C unless otherwise specified.)**

Parameter	Symbol	Min	Typ.	Max	Unit
Forward voltage (IF =10mA) (IF =100mA) (IF =200mA)	VF	- - -	- - -	0.855 1.2 1.25	V
Reverse current (VR =80V) (VR =100V)	IR	- -	- -	0.1 0.5	μA
Capacitance between terminals (VR =0.5V , f=1MHz)	CT	-	0.72	3	pF
Reverse recovery time (VR=6V,IF =10mA , RL =100Ohm)	trr	-	-	4	ns

**7.ELECTRICAL CHARACTERISTICS CURVES**

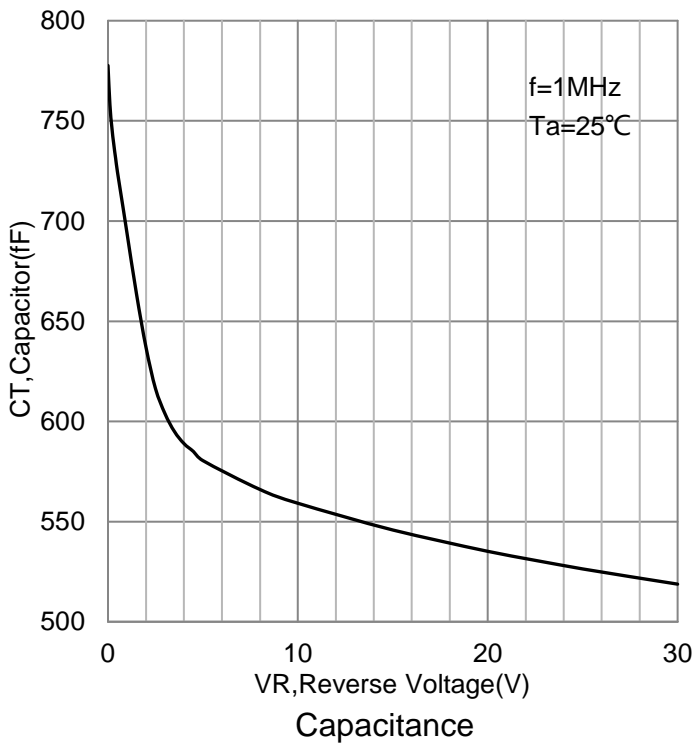
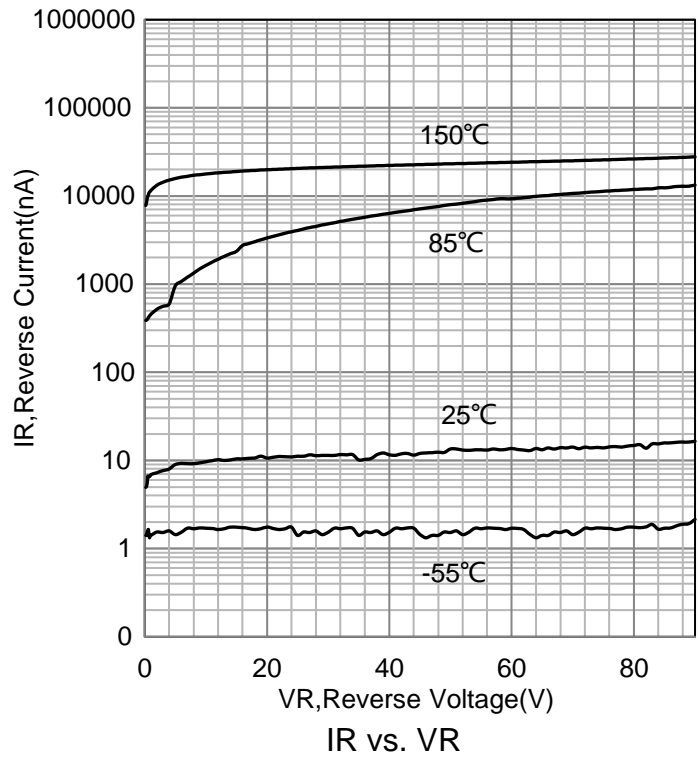
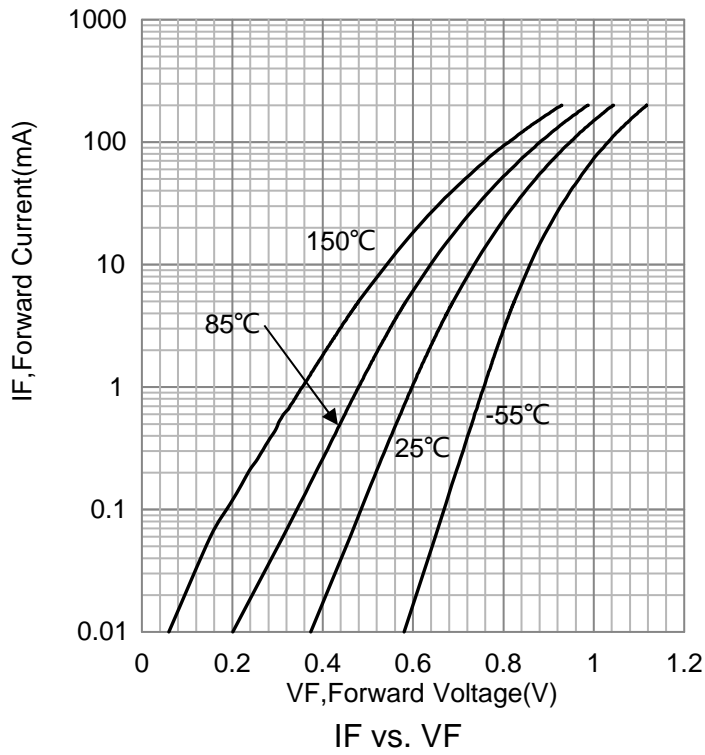

### 8. OUTLINE AND DIMENSIONS

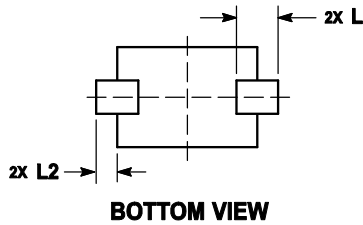
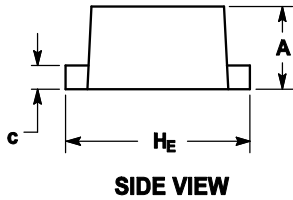
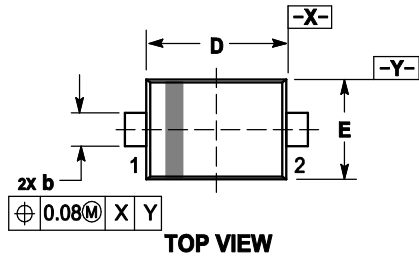

Notes:

1. DIMENSIONING AND TOLERANCING PER ANSI Y14.5M, 1982.
2. CONTROLLING DIMENSION: MILLIMETERS.
3. MAXIMUM LEAD THICKNESS INCLUDES LEAD FINISH. MINIMUM LEAD THICKNESS IS THE MINIMUM THICKNESS OF BASE MATERIAL.
4. DIMENSIONS D AND E DO NOT INCLUDE MOLD FLASH, PROTRUSIONS OR GATE BURRS.

DIM	MILLIMETERS			INCHES		
	MIN	NOM	MAX	MIN	NOM	MAX
A	0.50	0.60	0.70	0.020	0.024	0.028
b	0.25	0.30	0.35	0.010	0.012	0.014
c	0.07	0.14	0.20	0.003	0.006	0.008
D	1.10	1.20	1.30	0.043	0.047	0.051
E	0.70	0.80	0.90	0.028	0.031	0.035
H <sub>E</sub>	1.50	1.60	1.70	0.059	0.063	0.067
L	0.30 REF			0.012 REF		
L <sub>2</sub>	0.15	0.20	0.25	0.006	0.008	0.010

### 9. SOLDERING FOOTPRINT

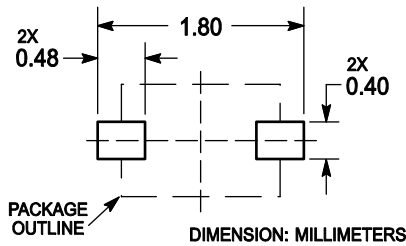

## **DISCLAIMER**

- Curve guarantee in the specification. The curve of test items with electric parameter is used as quality guarantee. The curve of test items without electric parameter is used as reference only.
- Before you use our Products for new Project, you are requested to carefully read this document and fully understand its contents. LRC shall not be in any way responsible or liable for failure, malfunction or accident arising from the use of any LRC's Products against warning, caution or note contained in this document.
- All information contained in this document is current as of the issuing date and subject to change without any prior notice. Before purchasing or using LRC's Products, please confirm the latest information with a LRC sales representative.

单击下面可查看定价，库存，交付和生命周期等信息

[>>LRC\(乐山无线电\)](#)