

General Purpose Transistors

NPN Silicon

- We declare that the material of product compliance with RoHS requirements.
- S- Prefix for Automotive and Other Applications Requiring Unique Site and Control Change Requirements; AEC-Q101 Qualified and PPAP Capable.

LBC817-16LT1G
LBC817-25LT1G
LBC817-40LT1G
S-LBC817-16LT1G
S-LBC817-25LT1G
S-LBC817-40LT1G

MAXIMUM RATINGS

| Rating | Symbol | Value | Unit |
|--------------------------------|-----------|-------|------|
| Collector–Emitter Voltage | V_{CEO} | 45 | V |
| Collector–Base Voltage | V_{CBO} | 50 | V |
| Emitter–Base Voltage | V_{EBO} | 5.0 | V |
| Collector Current — Continuous | I_C | 500 | mAdc |

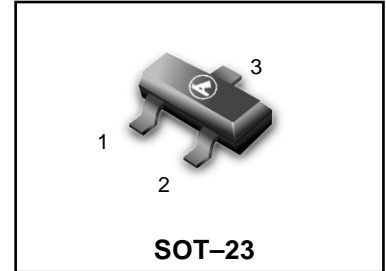

THERMAL CHARACTERISTICS

| Characteristic | Symbol | Max | Unit |
|---|-----------------|-------------|---------------------------|
| Total Device Dissipation FR– 5 Board, (1) $T_A = 25^\circ\text{C}$ | P_D | 225 | mW |
| Derate above 25°C | | 1.8 | mW/ $^\circ\text{C}$ |
| Thermal Resistance, Junction to Ambient | $R_{\theta JA}$ | 556 | $^\circ\text{C}/\text{W}$ |
| Total Device Dissipation Alumina Substrate, (2) $T_A = 25^\circ\text{C}$ | P_D | 300 | mW |
| Derate above 25°C | | 2.4 | mW/ $^\circ\text{C}$ |
| Thermal Resistance, Junction to Ambient | $R_{\theta JA}$ | 417 | $^\circ\text{C}/\text{W}$ |
| Junction and Storage Temperature | T_J, T_{stg} | -55 to +150 | $^\circ\text{C}$ |

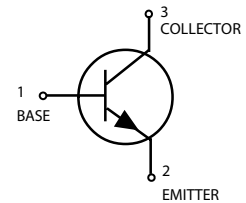

DEVICE MARKING

LBC817-16LT1G = 6A; LBC817-25LT1G = 6B; LBC817-40LT1G = 6C

ELECTRICAL CHARACTERISTICS ($T_A = 25^\circ\text{C}$ unless otherwise noted.)

| Characteristic | Symbol | Min | Typ | Max | Unit |
|----------------|--------|-----|-----|-----|------|
|----------------|--------|-----|-----|-----|------|

OFF CHARACTERISTICS

| | | | | | |
|--|---------------|-----|---|-----|---------------|
| Collector–Emitter Breakdown Voltage ($I_C = 10\text{ mA}$) | $V_{(BR)CEO}$ | 45 | — | — | V |
| Collector–Emitter Breakdown Voltage ($V_{EB} = 0, I_C = 10\ \mu\text{A}$) | $V_{(BR)CES}$ | 50 | — | — | V |
| Emitter–Base Breakdown Voltage ($I_E = 1.0\ \mu\text{A}$) | $V_{(BR)EBO}$ | 5.0 | — | — | V |
| Collector Cutoff Current ($V_{CB} = 20\text{ V}$) | I_{CBO} | — | — | 100 | nA |
| ($V_{CB} = 20\text{ V}, T_A = 150^\circ\text{C}$) | | — | — | 5.0 | μA |

1. FR-5 = 1.0 x 0.75 x 0.062 in.

2. Alumina = 0.4 x 0.3 x 0.024 in. 99.5% alumina.

LBC817-16LT1G LBC817-25LT1G LBC817-40LT1G
S-LBC817-16LT1G,S-LBC817-25LT1G,S-LBC817-40LT1G

ELECTRICAL CHARACTERISTICS ($T_A = 25^\circ\text{C}$ unless otherwise noted) (Continued)

| Characteristic | Symbol | Min | Typ | Max | Unit |
|----------------|--------|-----|-----|-----|------|
|----------------|--------|-----|-----|-----|------|

ON CHARACTERISTICS

| | | | | | |
|--|---------------|-----|---|-----|---|
| DC Current Gain ($I_C = 100\text{ mA}$, $V_{CE} = 1.0\text{ V}$) | h_{FE} | 100 | — | 250 | |
| | LBC817-16 | 160 | — | 400 | |
| | LBC817-25 | 250 | — | 600 | |
| | LBC817-40 | 40 | — | — | |
| ($I_C = 500\text{ mA}$, $V_{CE} = 1.0\text{ V}$) | | | | | |
| Collector-Emitter Saturation Voltage ($I_C = 500\text{ mA}$, $I_B = 50\text{ mA}$) | $V_{CE(sat)}$ | — | — | 0.7 | V |
| Base-Emitter On Voltage ($I_C = 500\text{ mA}$, $V_{CE} = 1.0\text{ V}$) | $V_{BE(on)}$ | — | — | 1.2 | V |

SMALL-SIGNAL CHARACTERISTICS

| | | | | | |
|--|-----------|-----|----|---|-----|
| Current-Gain — Bandwidth Product ($I_C = 10\text{ mA}$, $V_{CE} = 5.0\text{ V}_{dc}$, $f = 100\text{ MHz}$) | f_T | 100 | — | — | MHz |
| Output Capacitance ($V_{CB} = 10\text{ V}$, $f = 1.0\text{ MHz}$) | C_{obo} | — | 10 | — | pF |

ORDERING INFORMATION

| Device | Marking | Shipping |
|---------------|---------|-----------------|
| LBC817-16LT1G | 6A | 3000/Tape&Reel |
| LBC817-16LT3G | 6A | 10000/Tape&Reel |
| LBC817-25LT1G | 6B | 3000/Tape&Reel |
| LBC817-25LT3G | 6B | 10000/Tape&Reel |
| LBC817-40LT1G | 6C | 3000/Tape&Reel |
| LBC817-40LT3G | 6C | 10000/Tape&Reel |

LBC817-16LT1G LBC817-25LT1G LBC817-40LT1G
 S-LBC817-16LT1G,S-LBC817-25LT1G,S-LBC817-40LT1G

TYPICAL CHARACTERISTICS – LBC817-16LT1G

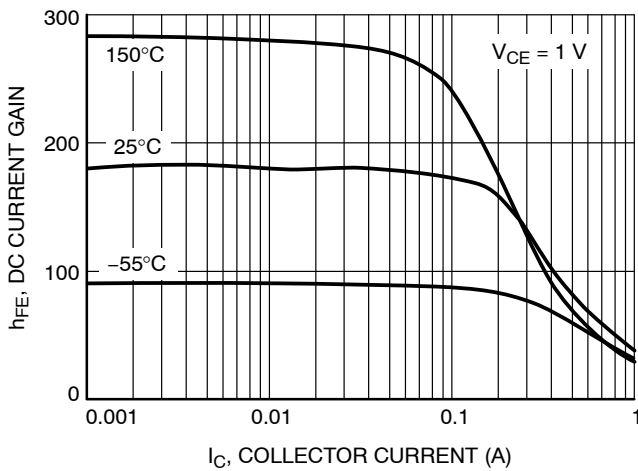

Figure 1. DC Current Gain vs. Collector Current

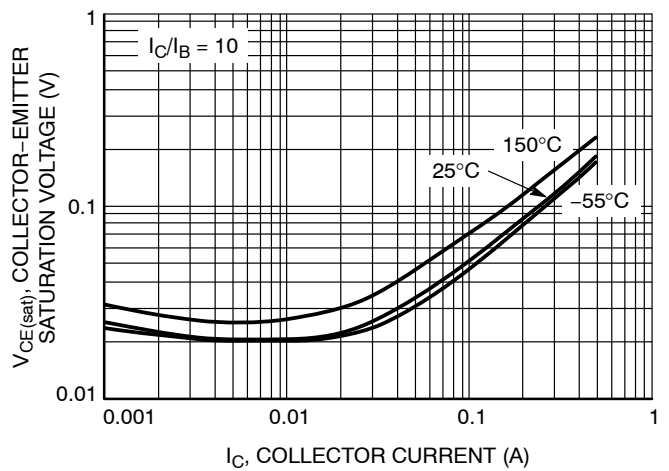

Figure 2. Collector Emitter Saturation Voltage vs. Collector Current

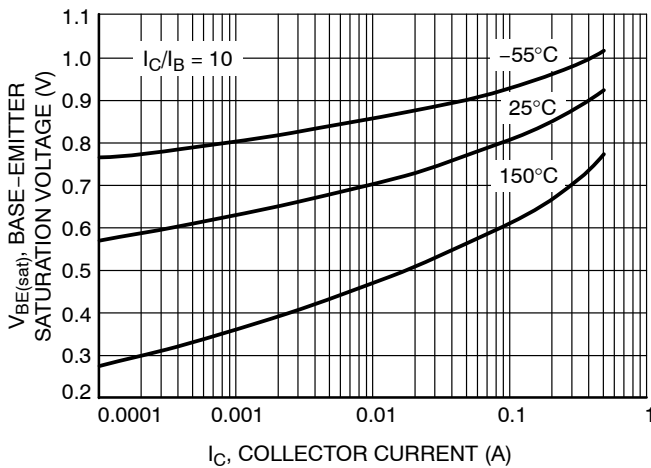

Figure 3. Base Emitter Saturation Voltage vs. Collector Current

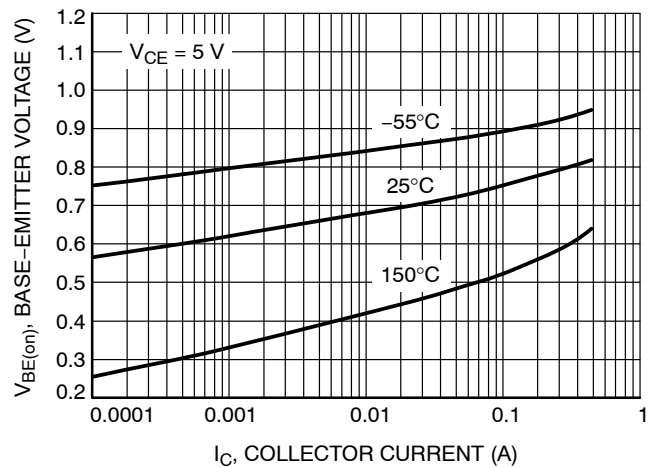

Figure 4. Base Emitter Voltage vs. Collector Current

LBC817-16LT1G LBC817-25LT1G LBC817-40LT1G
S-LBC817-16LT1G,S-LBC817-25LT1G,S-LBC817-40LT1G

TYPICAL CHARACTERISTICS - LBC817-16LT1G

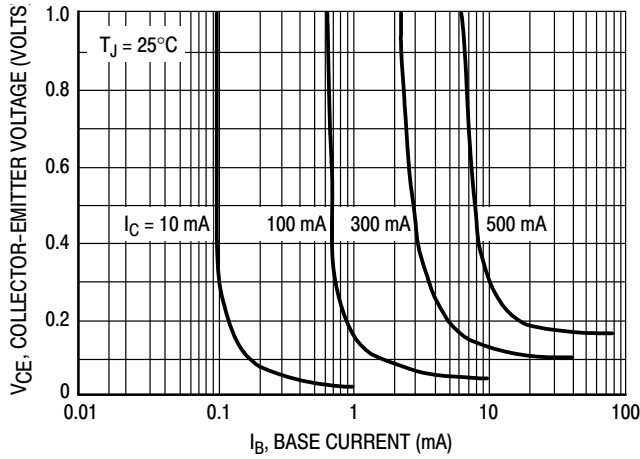

Figure 5. Saturation Region

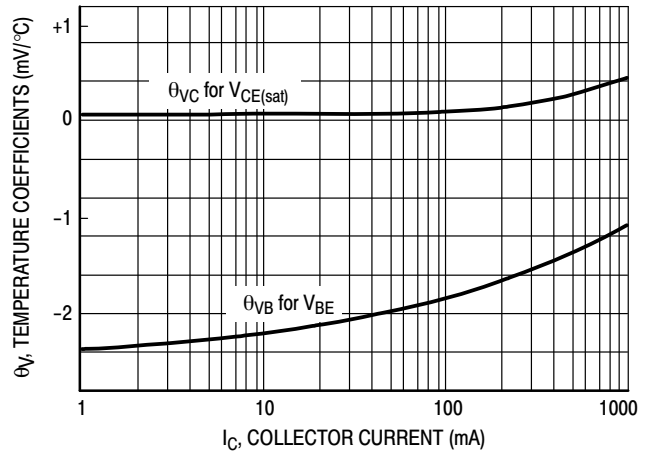

Figure 6. Temperature Coefficients

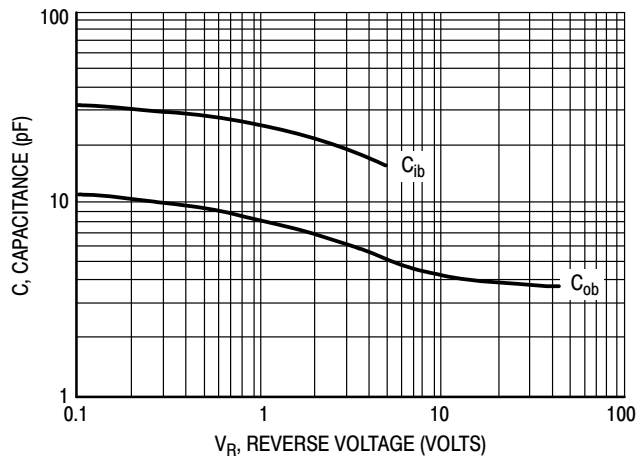

Figure 7. Capacitances

LBC817-16LT1G LBC817-25LT1G LBC817-40LT1G
 S-LBC817-16LT1G,S-LBC817-25LT1G,S-LBC817-40LT1G

TYPICAL CHARACTERISTICS – LBC817-25LT1G

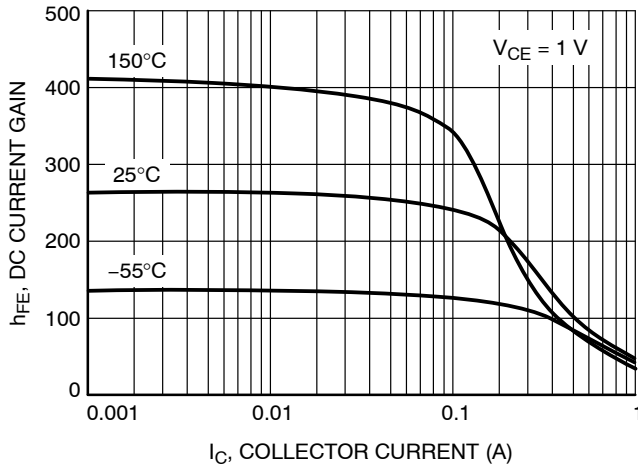

Figure 8. DC Current Gain vs. Collector Current

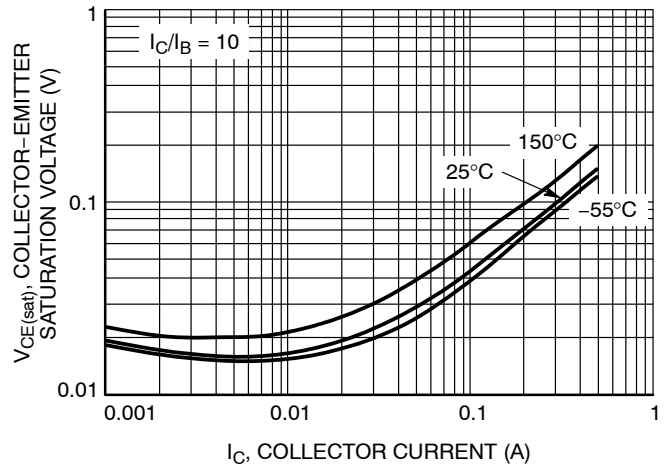

Figure 9. Collector Emitter Saturation Voltage vs. Collector Current

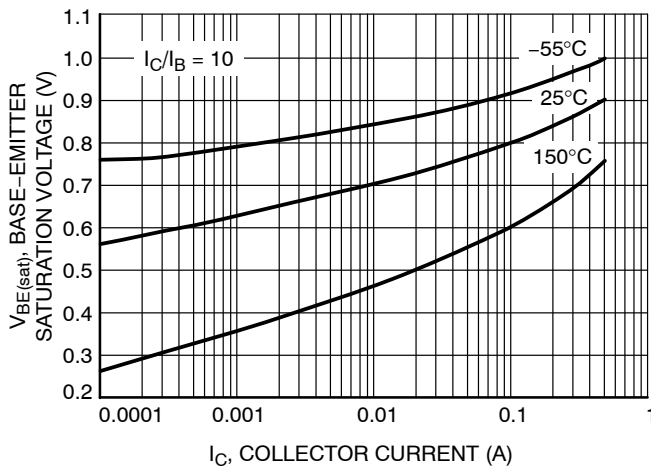

Figure 10. Base Emitter Saturation Voltage vs. Collector Current

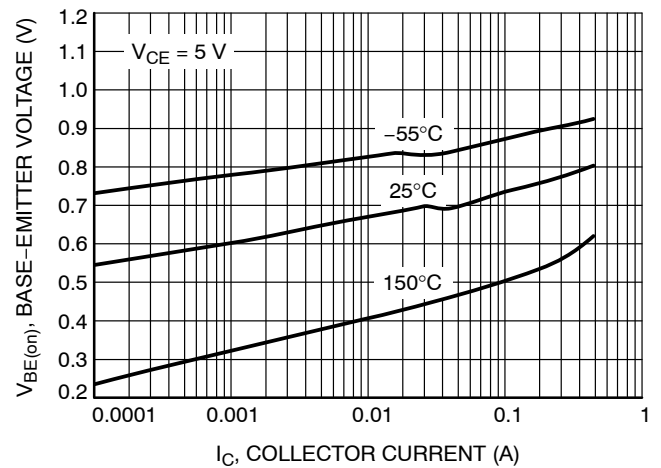

Figure 11. Base Emitter Voltage vs. Collector Current

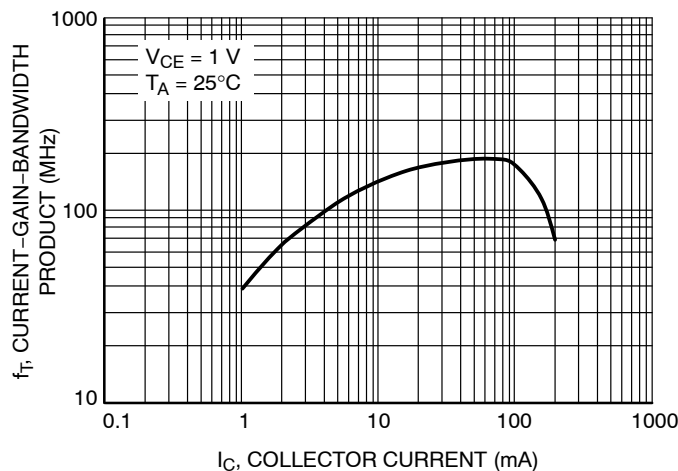

Figure 12. Current Gain Bandwidth Product vs. Collector Current

LBC817-16LT1G LBC817-25LT1G LBC817-40LT1G
 S-LBC817-16LT1G,S-LBC817-25LT1G,S-LBC817-40LT1G

TYPICAL CHARACTERISTICS - LBC817-25LT1G

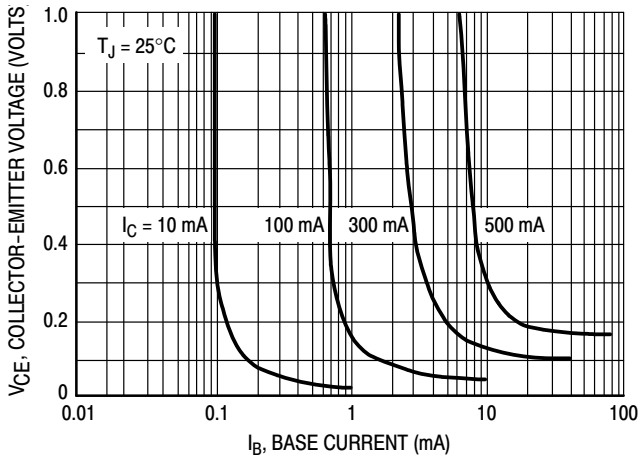

Figure 13. Saturation Region

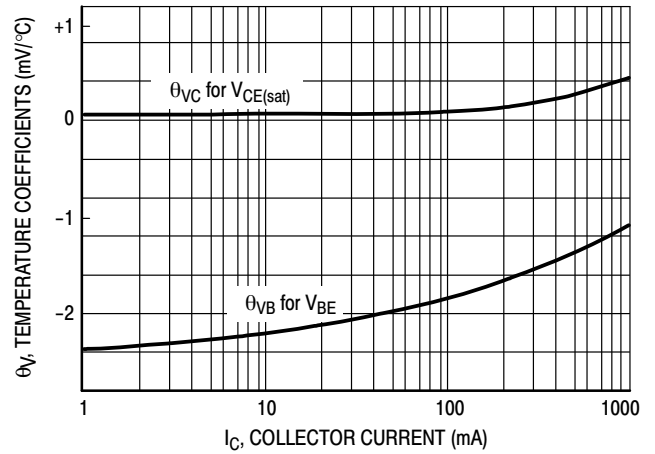

Figure 14. Temperature Coefficients

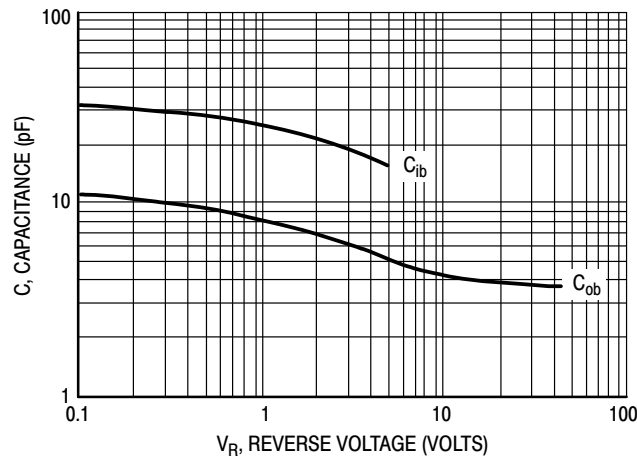

Figure 15. Capacitances

LBC817-16LT1G LBC817-25LT1G LBC817-40LT1G
S-LBC817-16LT1G,S-LBC817-25LT1G,S-LBC817-40LT1G

TYPICAL CHARACTERISTICS - LBC817-40LT1G

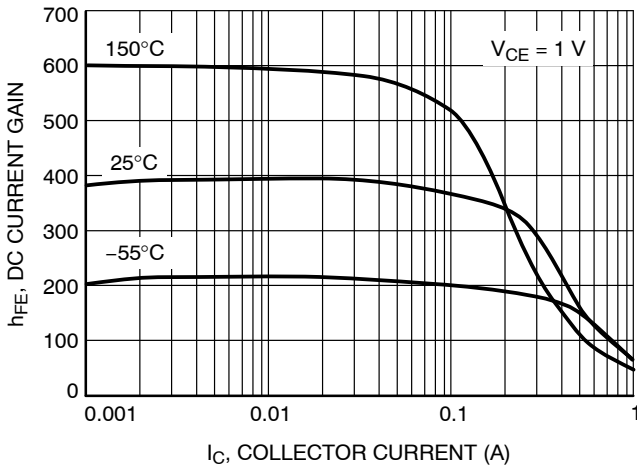

Figure 16. DC Current Gain vs. Collector Current

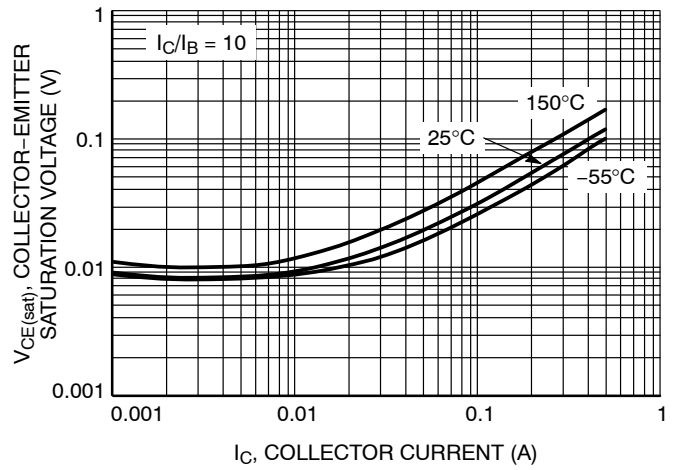

Figure 17. Collector Emitter Saturation Voltage vs. Collector Current

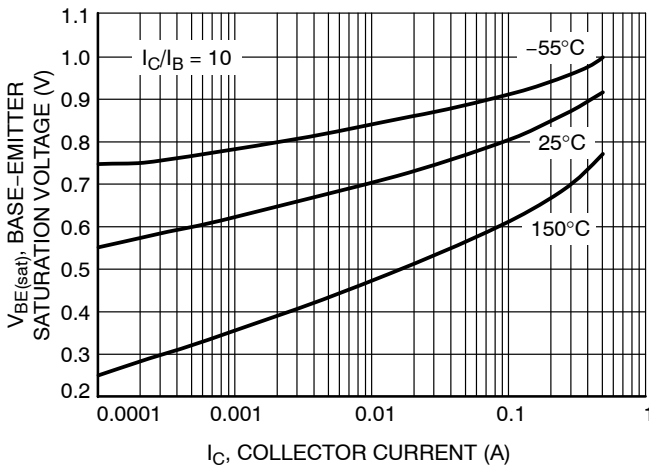

Figure 18. Base Emitter Saturation Voltage vs. Collector Current

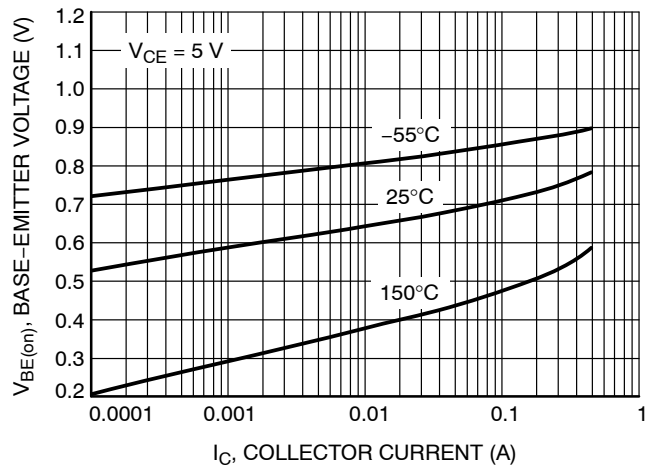

Figure 19. Base Emitter Voltage vs. Collector Current

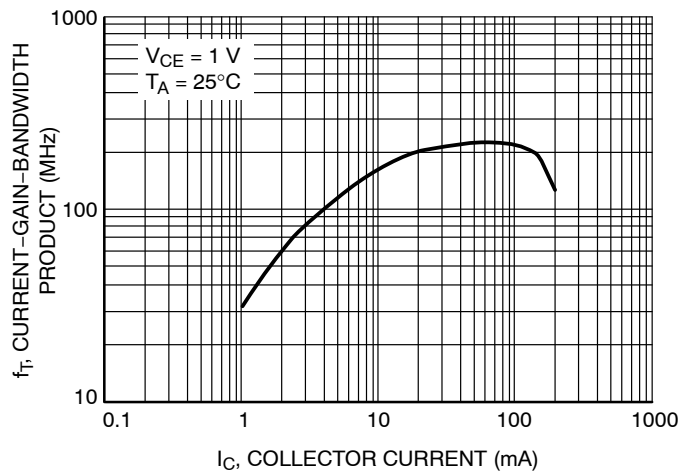

Figure 20. Current Gain Bandwidth Product vs. Collector Current

LBC817-16LT1G LBC817-25LT1G LBC817-40LT1G
 S-LBC817-16LT1G,S-LBC817-25LT1G,S-LBC817-40LT1G

TYPICAL CHARACTERISTICS - LBC817-40LT1G

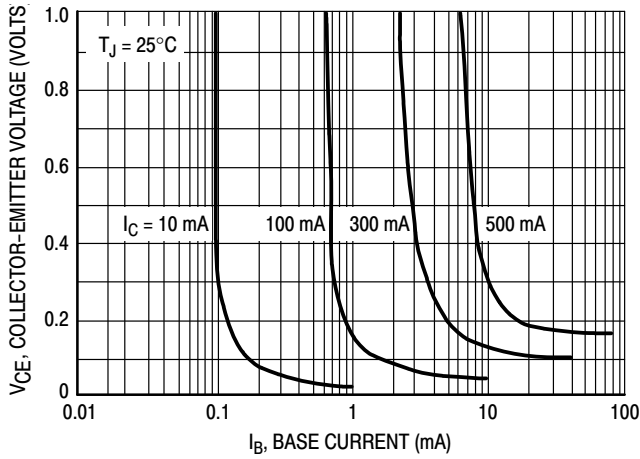

Figure 21. Saturation Region

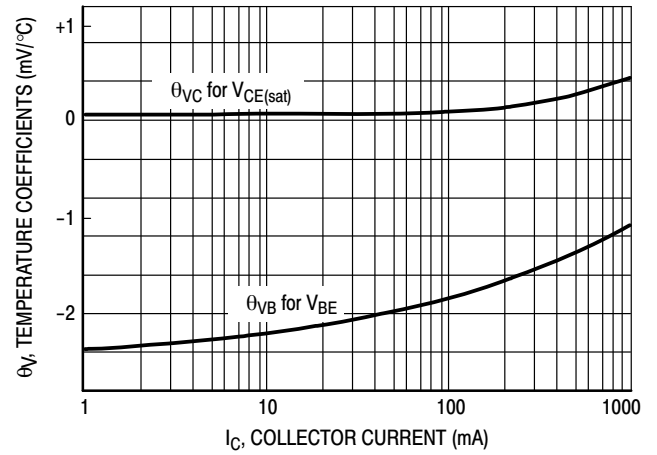

Figure 22. Temperature Coefficients

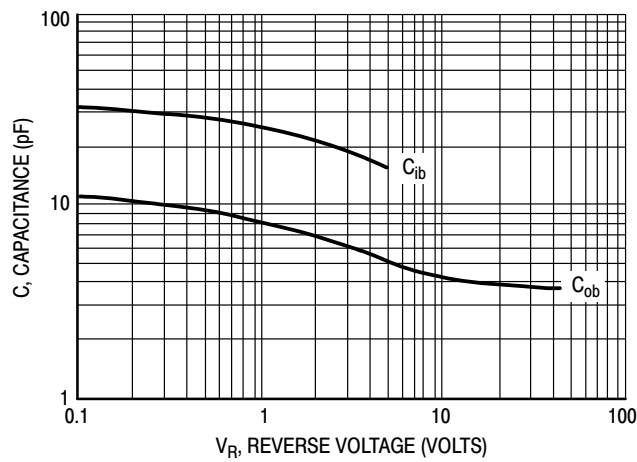

Figure 23. Capacitances

LBC817-16LT1G LBC817-25LT1G LBC817-40LT1G
S-LBC817-16LT1G,S-LBC817-25LT1G,S-LBC817-40LT1G

TYPICAL CHARACTERISTICS – LBC817-16LT1G LBC817-25LT1G LBC817-40LT1G

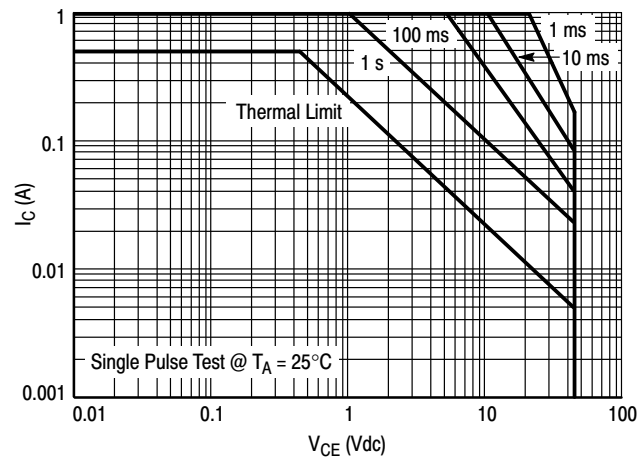
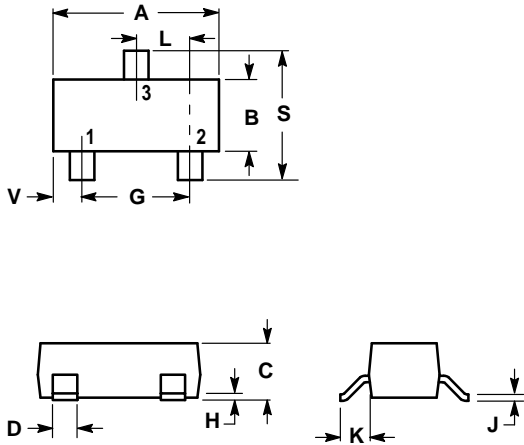

Figure 24. Safe Operating Area

LBC817-16LT1G LBC817-25LT1G LBC817-40LT1G
S-LBC817-16LT1G,S-LBC817-25LT1G,S-LBC817-40LT1G

SOT-23



NOTES:

1. DIMENSIONING AND TOLERANCING PER ANSI Y14.5M, 1982.
2. CONTROLLING DIMENSION: INCH.

| DIM | INCHES | | MILLIMETERS | |
|-----|--------|--------|-------------|-------|
| | MIN | MAX | MIN | MAX |
| A | 0.1102 | 0.1197 | 2.80 | 3.04 |
| B | 0.0472 | 0.0551 | 1.20 | 1.40 |
| C | 0.0350 | 0.0440 | 0.89 | 1.11 |
| D | 0.0150 | 0.0200 | 0.37 | 0.50 |
| G | 0.0701 | 0.0807 | 1.78 | 2.04 |
| H | 0.0005 | 0.0040 | 0.013 | 0.100 |
| J | 0.0034 | 0.0070 | 0.085 | 0.177 |
| K | 0.0140 | 0.0285 | 0.35 | 0.69 |
| L | 0.0350 | 0.0401 | 0.89 | 1.02 |
| S | 0.0830 | 0.1039 | 2.10 | 2.64 |
| V | 0.0177 | 0.0236 | 0.45 | 0.60 |

- PIN 1. BASE
2. EMITTER
3. COLLECTOR

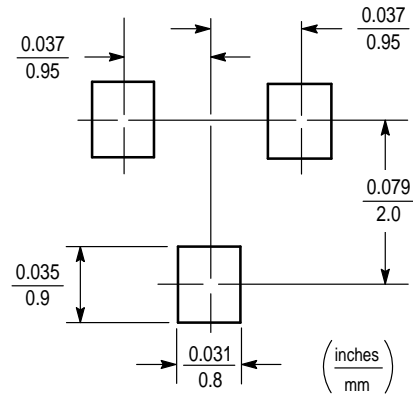

单击下面可查看定价，库存，交付和生命周期等信息

[>>LRC\(乐山无线电\)](#)