

LBSS5350SY3T1G

S-LBSS5350SY3T1G

PNP TRANSISTOR

1. FEATURES

- Low collector-to-emitter saturation voltage.
- Fast switching speed.
- Large current capacity and wide ASO.
- We declare that the material of product compliance with RoHS requirements and Halogen Free.
- S- prefix for automotive and other applications requiring unique site and control change requirements; AEC-Q101 qualified and PPAP capable.

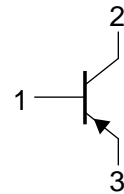
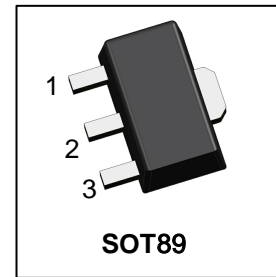

2. DEVICE MARKING AND ORDERING INFORMATION

Device	Marking	Shipping
LBSS5350SY3T1G	D3	1000/Tape&Reel

3. MAXIMUM RATINGS(Ta = 25°C)

Parameter	Symbol	Limits	Unit
Collector–Emitter Voltage	VCEO	-50	V
Collector–Base Voltage	VCBO	-60	V
Emitter–Base Voltage	VEBO	-6	V
Collector Current	IC	-3	A
Collector Current(Pulse)	ICP	-6	A

4. THERMAL CHARACTERISTICS

Parameter	Symbol	Limits	Unit
Total Device Dissipation, FR-4 Board (Note 1) @ TA = 25°C Derate above 25°C	PD	550 4.4	mW mW/°C
Thermal Resistance, Junction–to–Ambient	RθJA	225	°C/W
Junction and Storage temperature	TJ, Tstg	-55~+150	°C

1.PCB Size:30.0mm×25.0mm×1.6mm,FR-4 Board;

5. ELECTRICAL CHARACTERISTICS (Ta= 25°C)

Characteristic	Symbol	Min.	Typ.	Max.	Unit
Collector Cutoff Current (VCB = -40 V, IE = 0)	ICBO	-	-	-1	μA
Emitter Cut-off Current (VEB = -4V, IC = 0)	IEBO	-	-	-1	μA
DC Current Gain (VCE = -2V, IC = -100mA) (VCE = -2V, IC = -3A)	HFE	200 35	- -	400 -	
Collector–Emitter Saturation Voltage (IC = -2A, IB = -100mA)	VCE(sat)	-	-0.35	-0.7	V
Base-Emitter saturation voltage (IC = -2A, IB = -100mA)	VBE(sat)	-	-0.94	-1.2	V
Transition Frequency (VCE = -10V, IC = -50mA)	fT	-	150	-	MHz
Collector Output Capacitance (VCB = -10V, f=1MHz)	Cob	-	39	-	pF

6.ELECTRICAL CHARACTERISTICS CURVES

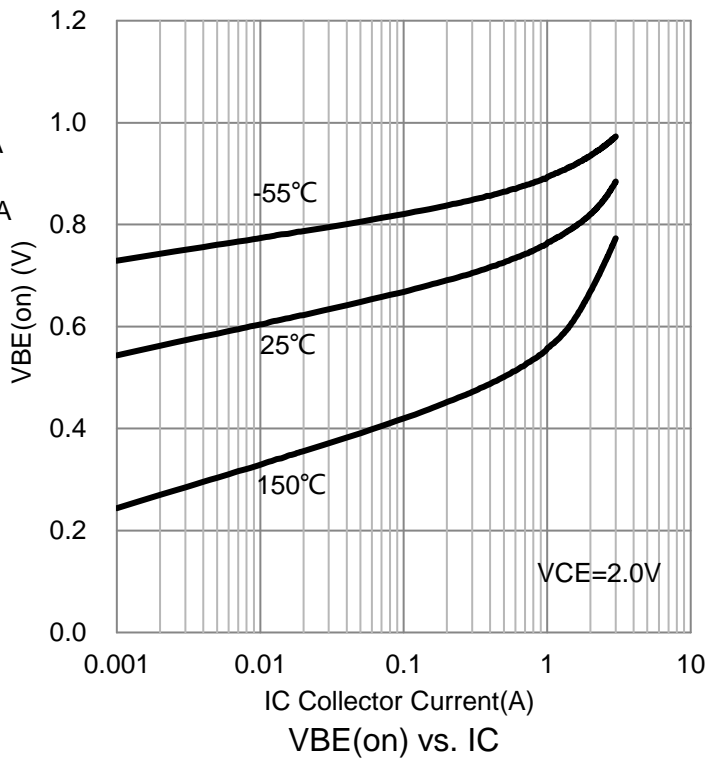
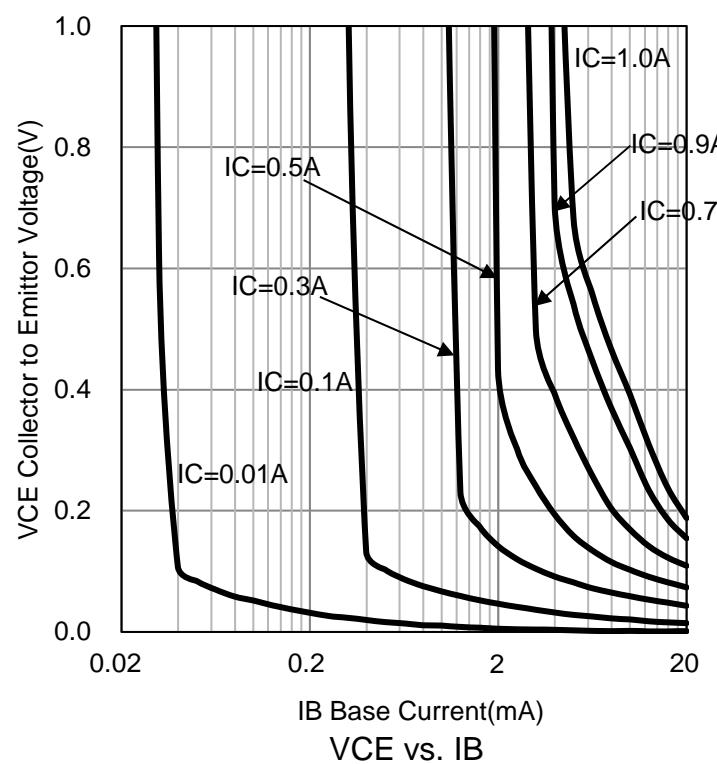
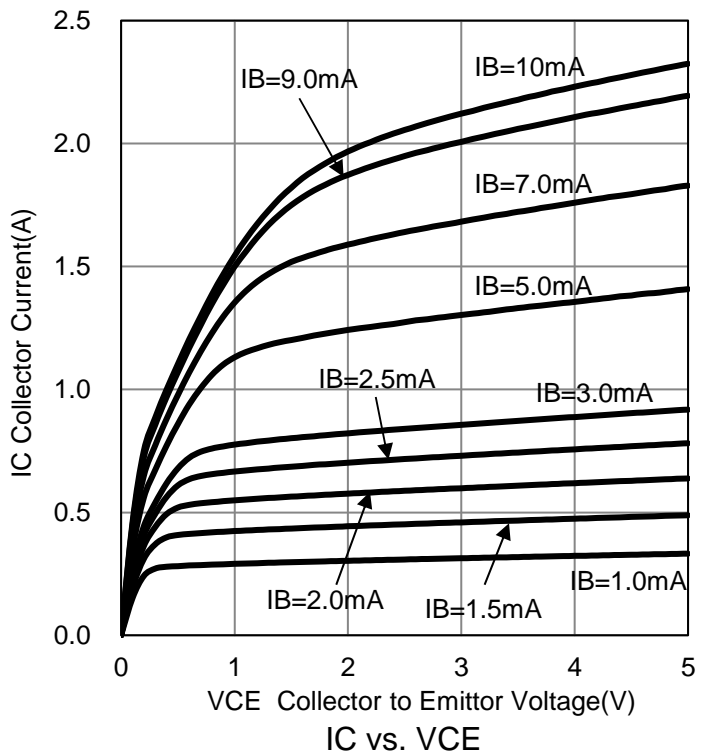
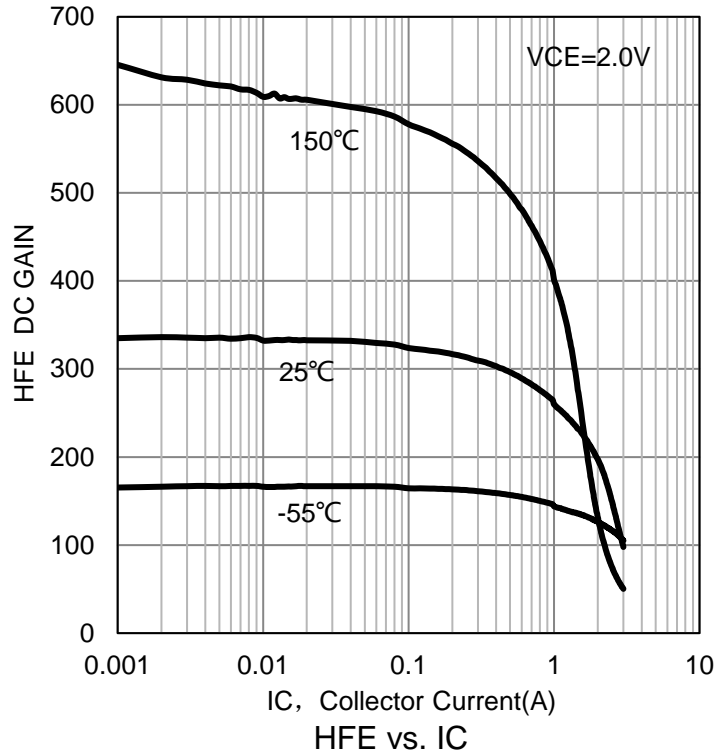

6.ELECTRICAL CHARACTERISTICS CURVES(Con.)

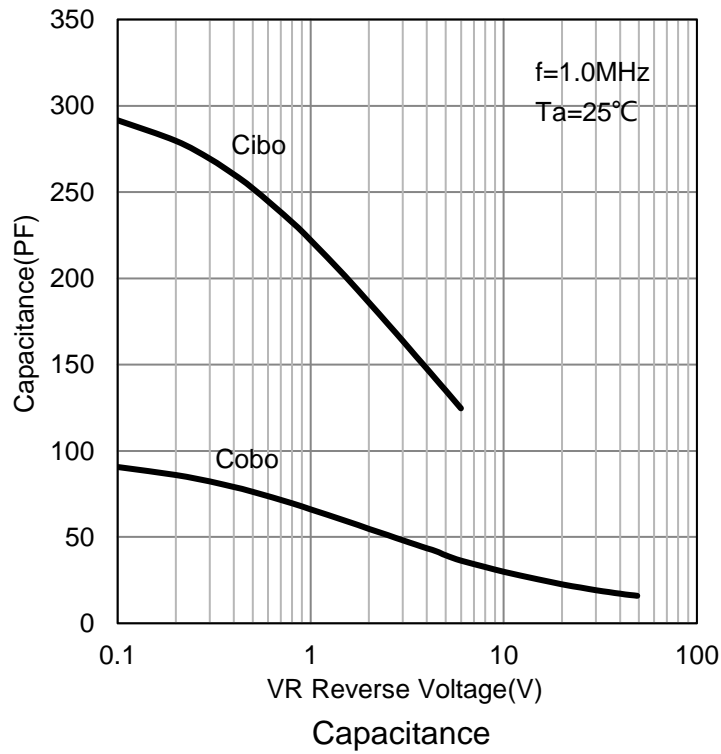
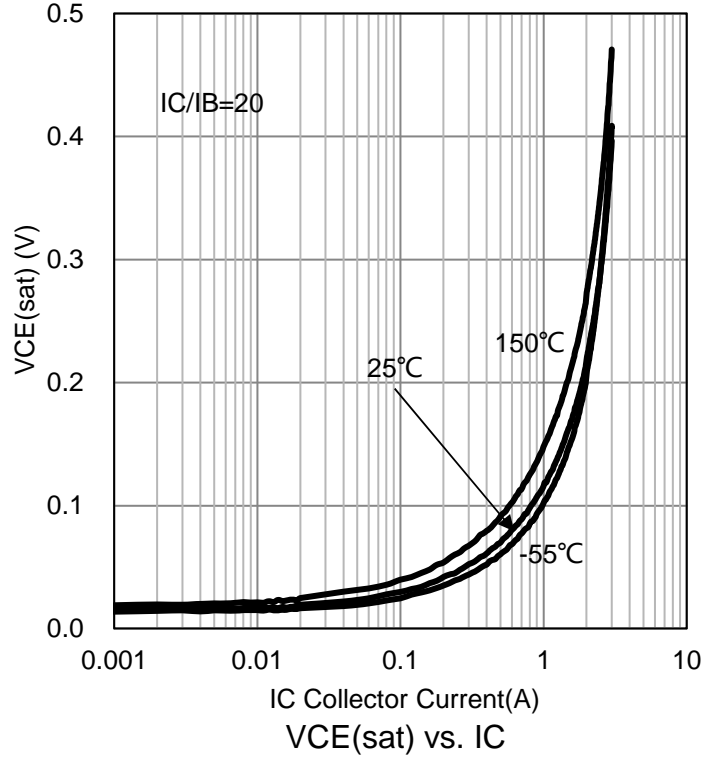
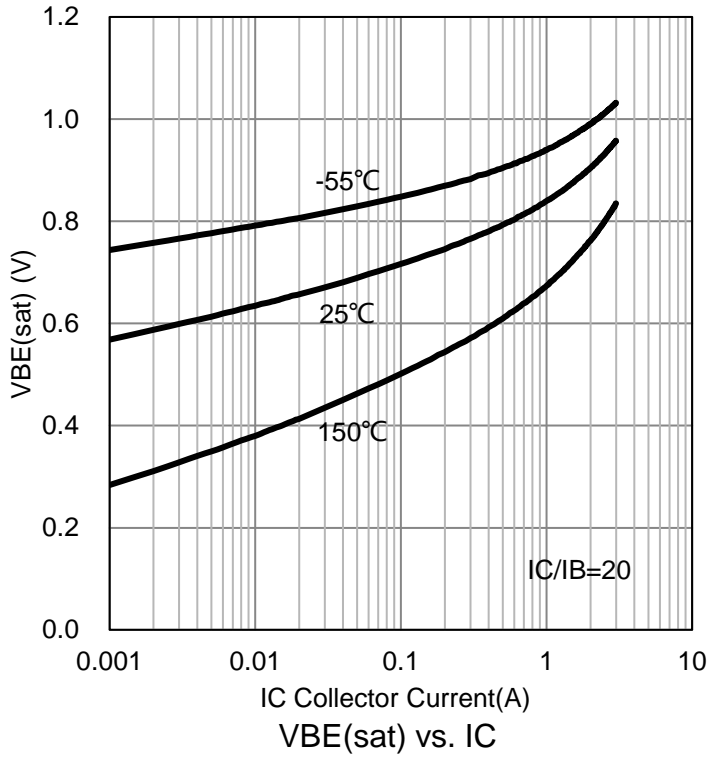

7. OUTLINE AND DIMENSIONS

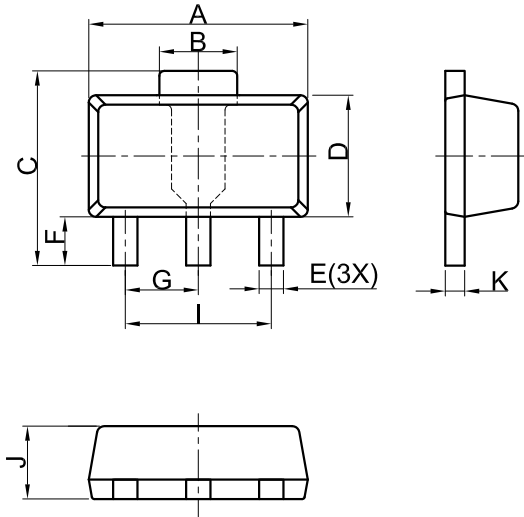

SOT89			
DIM	MIN	NOR	MAX
A	4.30	4.50	4.70
B	1.40	1.60	1.80
C	3.90	4.00	4.25
D	2.30	2.50	2.70
E	0.40	0.50	0.58
F	0.90	1.00	1.20
G	1.50 BSC		
I	3.00 BSC		
J	1.40	1.50	1.60
K	0.34	0.40	0.50
All Dimensions in mm			

GENERAL NOTES

1. Top package surface finish Ra0.4±0.2um
2. Bottom package surface finish Ra0.7±0.2um
3. Side package surface finish Ra0.4±0.2um
4. Protrusion or Gate Burrs shall not exceed 0.10mm per side.

8. SOLDERING FOOTPRINT

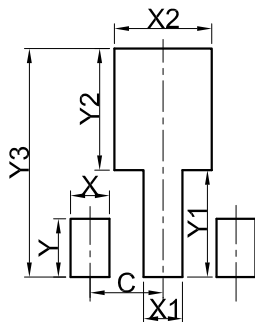

SOT89	
DIM	(mm)
X	0.80
Y	1.20
X1	0.80
Y1	2.20
X2	2.00
Y2	2.50
C	1.50
Y3	4.70

单击下面可查看定价，库存，交付和生命周期等信息

[>>LRC\(乐山无线电\)](#)