

# LBSS5350SZ4TZHG

## S-LBSS5350SZ4TZHG

### PNP TRANSISTOR

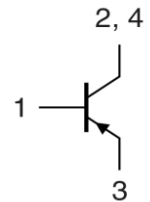
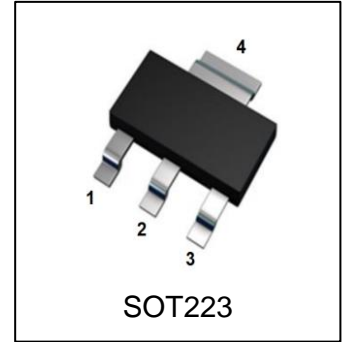

#### 1. FEATURES

- Low collector-to-emitter saturation voltage.
- Fast switching speed.
- Large current capacity and wide ASO.
- We declare that the material of product compliance with RoHS requirements and Halogen Free.
- S- prefix for automotive and other applications requiring unique site and control change requirements; AEC-Q101 qualified and PPAP capable.

#### 2. DEVICE MARKING AND ORDERING INFORMATION

Device	Marking	Shipping
LBSS5350SZ4TZHG	A6	1000/Tape&Reel

#### 3. MAXIMUM RATINGS(Ta = 25°C)

Parameter	Symbol	Limits	Unit
Collector–Emitter Voltage	VCEO	-50	V
Collector–Base Voltage	VCBO	-60	V
Emitter–Base Voltage	VEBO	-6	V
Collector Current	IC	-3	A
Collector Current(Pulse)	ICP	-6	A
Junction and Storage temperature	TJ,Tstg	-55~+150	°C

#### 4. THERMAL CHARACTERISTICS

Parameter	Symbol	Limits	Unit
Total Device Dissipation, FR-4 Board (Note 1) @ TA = 25°C	PD	833	mW
Thermal Resistance, Junction–to–Ambient(Note 1)	RθJA	150	°C/W

1. FR-4 = 30.0mm×25.0mm×1.6mm.

**5. ELECTRICAL CHARACTERISTICS (Ta= 25°C)**

Characteristic	Symbol	Min.	Typ.	Max.	Unit
Collector–Emitter Breakdown Voltage (IC = -1mA, IB = 0)	VBR(CEO)	-50	-	-	V
Collector–Base Breakdown Voltage (IC = -100 μA, IE = 0)	VBR(CBO)	-60	-	-	V
Emitter–Base Breakdown Voltage (IE = -100 μA, IC = 0)	VBR(EBO)	-6	-	-	V
Collector Cutoff Current (VCB = -40 V, IE = 0)	ICBO	-	-	-1	μA
Emitter Cut-off Current (VEB = -4V, IC = 0)	IEBO	-	-	-1	μA
Collector-Emitter cutoff Current (VCE = -50V, IB = 0)	ICEO	-	-	-10	μA
DC Current Gain (VCE = -2V, IC = -100mA) (VCE = -2V, IC = -3A)	HFE	200 35	- -	400 -	
Collector–Emitter Saturation Voltage (IC = -2A, IB = -100mA)	VCE(sat)	-	-0.35	-0.7	V
Base-Emitter saturation voltage (IC = -2A, IB = -100mA)	VBE(sat)	-	-0.94	-1.2	V
Transition Frequency (VCE = -10V, IC = -50mA)	fT	-	150	-	MHz
Collector Output Capacitance (VCB = -10V, f = 1MHz)	Cob	-	39	-	pF

6.ELECTRICAL CHARACTERISTICS CURVES

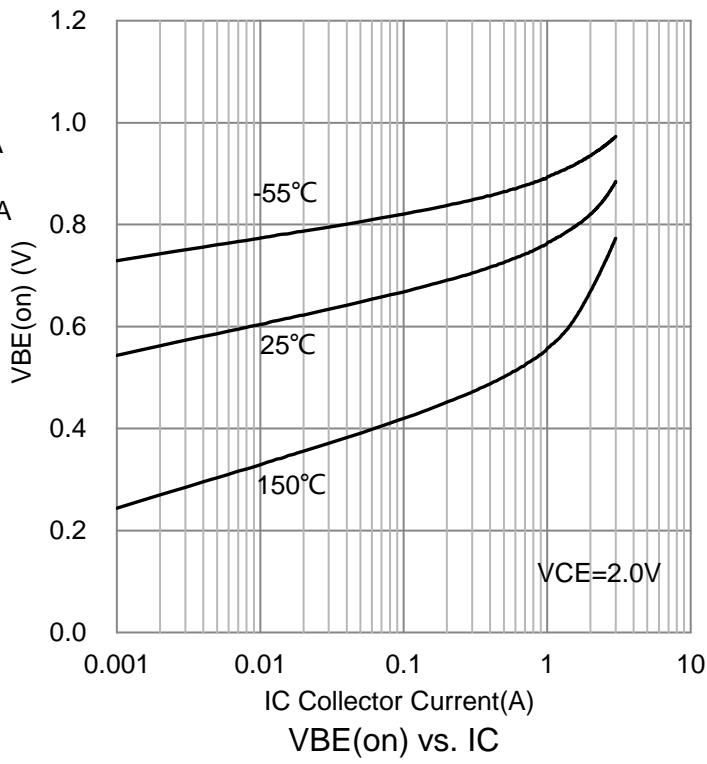
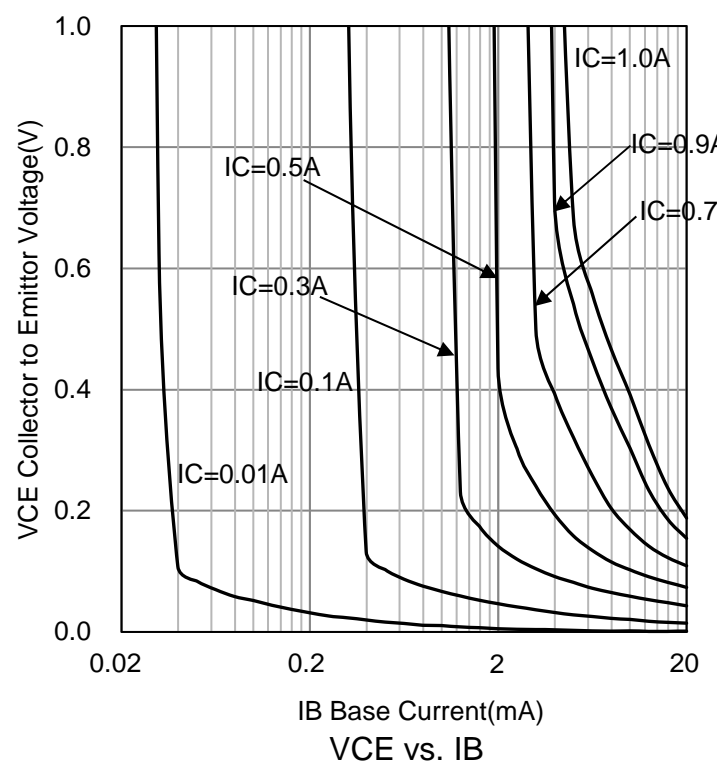
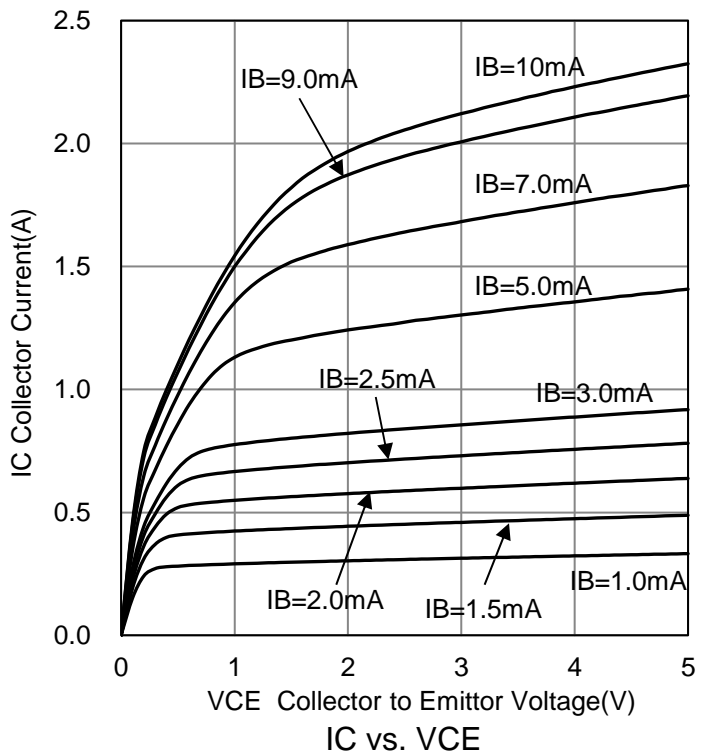
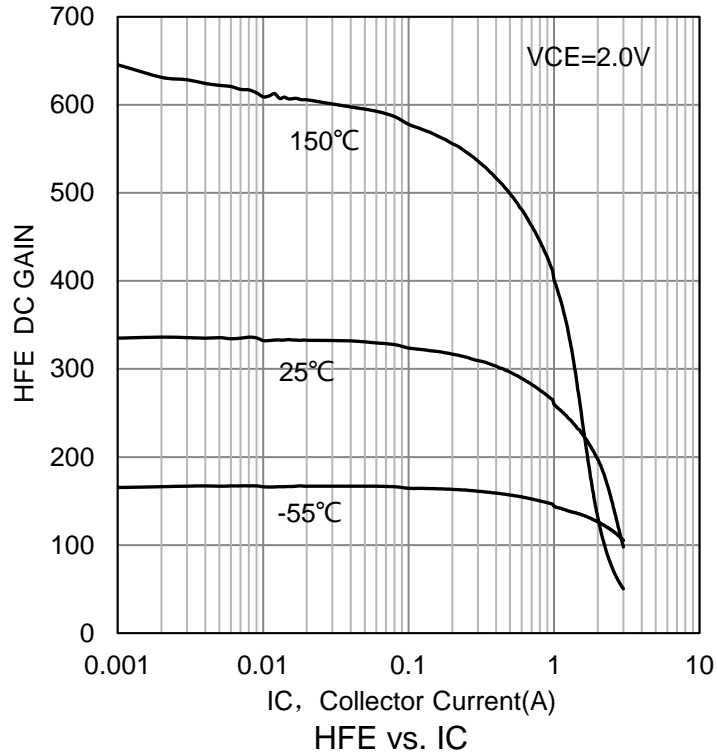

6.ELECTRICAL CHARACTERISTICS CURVES(Con.)

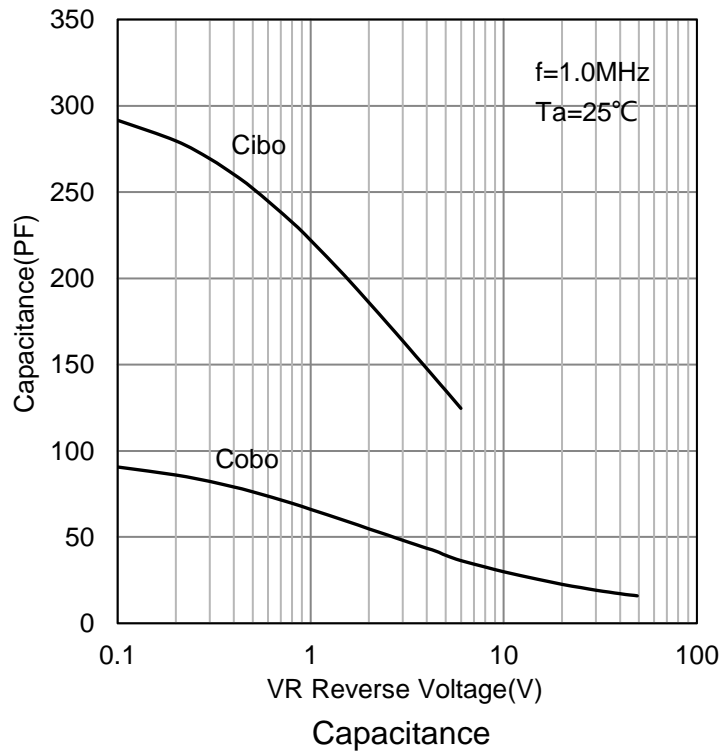
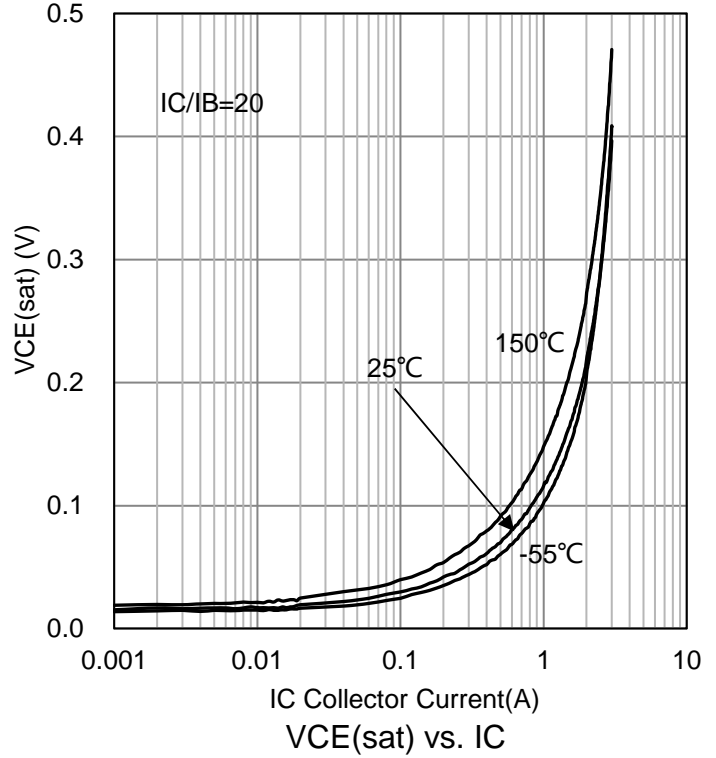
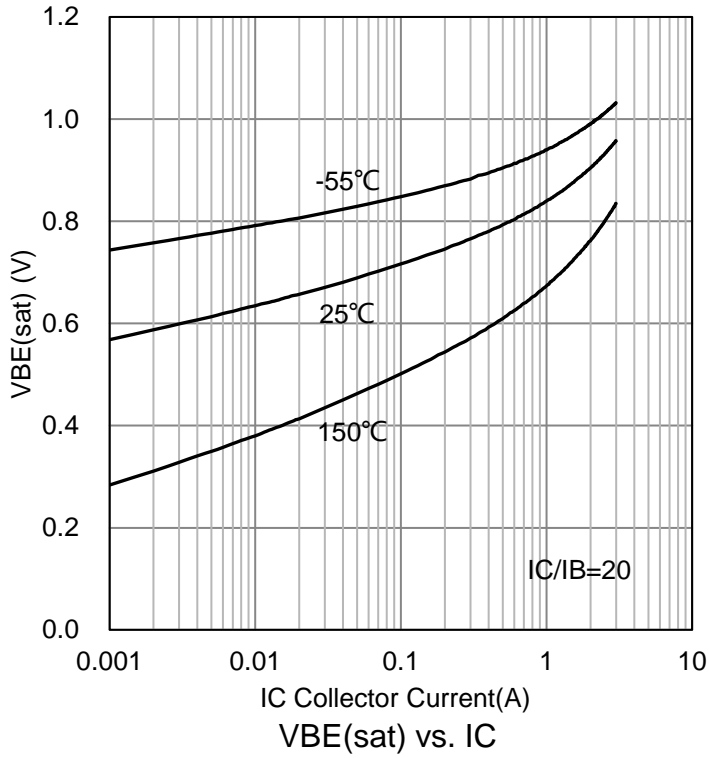

### 7.OUTLINE AND DIMENSIONS

#### SOT223

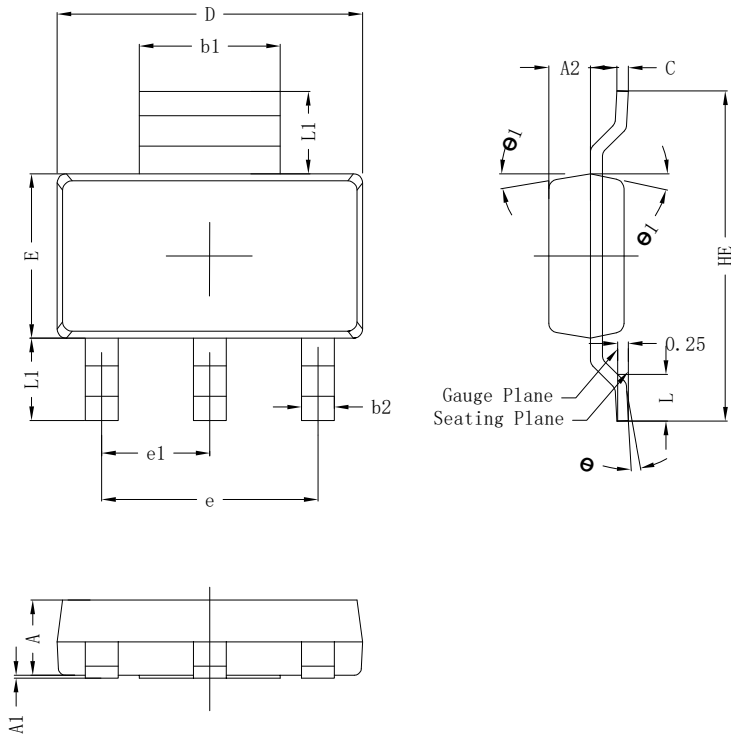

SOT223			
DIM	MIN	NOR	MAX
A	1.50	1.60	1.70
A1	0.00	0.05	0.10
A2	0.80	0.90	1.00
b1	2.90	3.02	3.10
b2	0.60	0.72	0.80
c	0.20	0.27	0.35
D	6.30	6.50	6.70
E	3.30	3.50	3.70
e	4.60BSC		
e1	2.30BSC		
HE	6.80	7.00	7.20
L	0.80	1.00	1.20
L1	1.75(REF)		
θ	0°~8°		
θ 1	8°	10°	12°
All Dimensions in mm			

#### GENERAL NOTES

1. Top package surface finish Ra0.4±0.2um
2. Bottom package surface finish Ra0.7±0.2um
3. Side package surface finish Ra0.4±0.2um
4. Protrusion or Gate Burrs shall not exceed 0.10mm per side.

### 8.SOLDERING FOOTPRINT

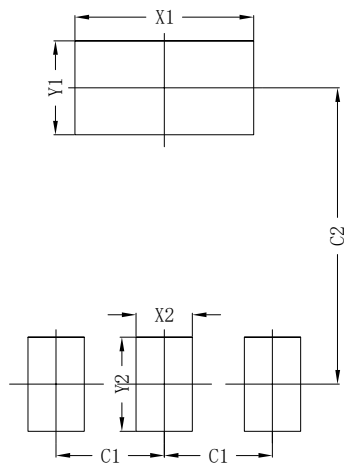

SOT223	
DIM	(mm)
X1	3.80
Y1	2.00
X2	1.20
Y2	2.00
C1	2.30
C2	6.30

## DISCLAIMER

- Before you use our Products, you are requested to carefully read this document and fully understand its contents. LRC shall not be in any way responsible or liable for failure, malfunction or accident arising from the use of any LRC's Products against warning, caution or note contained in this document.
- All information contained in this document is current as of the issuing date and subject to change without any prior notice. Before purchasing or using LRC's Products, please confirm the latest information with a LRC sales representative.

单击下面可查看定价，库存，交付和生命周期等信息

[>>LRC\(乐山无线电\)](#)