

Dual General Purpose Transistor

Features

- We declare that the material of product compliance with RoHS requirements.
- S- Prefix for Automotive and Other Applications Requiring Unique Site and Control Change Requirements; AEC-Q101 Qualified and PPAP Capable.

MAXIMUM RATINGS

Rating	Symbol	Value		Unit
		2907	2907A	
Collector–Emitter Voltage	V_{CEO}	-40	-60	Vdc
Collector–Base Voltage	V_{CBO}	-60		Vdc
Emitter–Base Voltage	V_{EBO}	-5.0		Vdc
Collector Current — Continuous	I_C	-600		mAdc

THERMAL CHARACTERISTICS

Characteristic	Symbol	Max	Unit
Total Device Dissipation FR–5 Board, (1) $T_A = 25^\circ\text{C}$	P_D	225	mW
Derate above 25°C		1.8	mW/ $^\circ\text{C}$
Thermal Resistance, Junction to Ambient	$R_{\theta JA}$	556	$^\circ\text{C}/\text{W}$
Total Device Dissipation Alumina Substrate, (2) $T_A = 25^\circ\text{C}$	P_D	300	mW
Derate above 25°C		2.4	mW/ $^\circ\text{C}$
Thermal Resistance, Junction to Ambient	$R_{\theta JA}$	417	$^\circ\text{C}/\text{W}$
Junction and Storage Temperature	T_J, T_{stg}	-55 to +150	$^\circ\text{C}$

DEVICE MARKING

(S-)LMBT2907DW1T1G = M2B, (S-)LMBT2907ADW1T1G = 2F

ELECTRICAL CHARACTERISTICS ($T_A = 25^\circ\text{C}$ unless otherwise noted.)

Characteristic	Symbol	Min	Max	Unit
----------------	--------	-----	-----	------

OFF CHARACTERISTICS

Collector–Emitter Breakdown Voltage(3) ($I_C = -10\text{ mAdc}, I_E = 0$)	$V_{(BR)CEO}$			Vdc
	LMBT2907	-40	—	
	LMBT2907A	-60	—	
Collector–Emitter Breakdown Voltage($I_C = -10\ \mu\text{Adc}, I_E = 0$)	$V_{(BR)CBO}$	-60	—	Vdc
Emitter–Base Breakdown Voltage($I_E = -10\ \mu\text{Adc}, I_C = 0$)	$V_{(BR)EBO}$	-5.0	—	Vdc
Collector Cutoff Current($V_{CB} = -30\text{Vdc}, I_{BE(OFF)} = -0.5\text{Vdc}$)	I_{CEX}	—	-50	nAdc
Collector Cutoff Current ($V_{CB} = -50\text{Vdc}, I_E = 0$)	I_{CBO}			μAdc
	LMBT2907	—	-0.020	
	LMBT2907A	—	-0.010	
	LMBT2907	—	-20	
($V_{CB} = -50\text{Vdc}, I_E = 0, T_A = 125^\circ\text{C}$)	LMBT2907A	—	-10	
Base Current($V_{CE} = -30\text{Vdc}, V_{EB(OFF)} = -0.5\text{Vdc}$)	I_B	—	-50	nAdc

1. FR-5 = 1.0 x 0.75 x 0.062 in.

2. Alumina = 0.4 x 0.3 x 0.024 in. 99.5% alumina.

3. Pulse Test: Pulse Width $\leq 300\ \mu\text{s}$, Duty Cycle $\leq 2.0\%$.

LMBT2907DW1T1G
LMBT2907ADW1T1G
S-LMBT2907DW1T1G
S-LMBT2907ADW1T1G

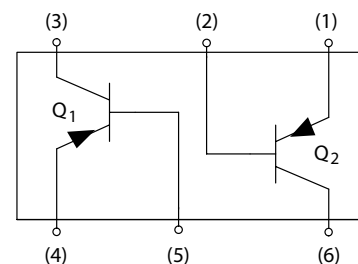
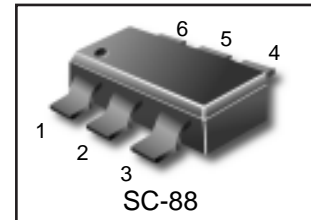

ORDERING INFORMATION

Device	Packing	Shipping
LMBT2907ADW1T1G S-LMBT2907ADW1T1G	SC88	3000 Units/Reel
LMBT2907ADW1T3G S-LMBT2907ADW1T1G	SC88	10000 Units/Reel

**LMBT2907DW1T1G, LMBT2907ADW1T1G
S-LMBT2907DW1T1G, S-LMBT2907ADW1T1G**
ELECTRICAL CHARACTERISTICS ($T_A = 25^\circ\text{C}$ unless otherwise noted) (Continued)

Characteristic	Symbol	Min	Max	Unit
ON CHARACTERISTICS				
DC Current Gain ($I_C = -0.1\text{mA dc}$, $V_{CE} = -10\text{V dc}$)	h_{FE}	35	—	—
	LMBT2907	75	—	
	LMBT2907A	—	—	
($I_C = -1.0\text{mA dc}$, $V_{CE} = -10\text{V dc}$)	LMBT2907	50	—	
	LMBT2907A	100	—	
($I_C = -10\text{mA dc}$, $V_{CE} = -10\text{V dc}$)	LMBT2907	75	—	
	LMBT2907A	100	—	
($I_C = -150\text{mA dc}$, $V_{CE} = -10\text{V dc}$)(3)	LMBT2907	—	—	
	LMBT2907A	100	300	
($I_C = -500\text{mA dc}$, $V_{CE} = -10\text{V dc}$)(3)	LMBT2907	30	—	
	LMBT2907A	50	—	
Collector–Emitter Saturation Voltage(3) ($I_C = -150\text{mA dc}$, $I_B = -15\text{mA dc}$) ($I_C = -500\text{mA dc}$, $I_B = -50\text{mA dc}$)	$V_{CE(sat)}$	—	-0.4 -1.6	Vdc
Base–Emitter Saturation Voltage(3) ($I_C = -150\text{mA dc}$, $I_B = -15\text{mA dc}$) ($I_C = -500\text{mA dc}$, $I_B = -50\text{mA dc}$)	$V_{BE(sat)}$	—	-1.3 -2.6	Vdc

SMALL-SIGNAL CHARACTERISTICS

Current–Gain — Bandwidth Product(3),(4) ($I_C = -50\text{mA dc}$, $V_{CE} = -20\text{V dc}$, $f = 100\text{MHz}$)	f_T	200	—	MHz
Output Capacitance ($V_{CB} = -10\text{V dc}$, $I_E = 0$, $f = 1.0\text{MHz}$)	C_{obo}	—	8.0	pF
Input Capacitance ($V_{EB} = -2.0\text{V dc}$, $I_C = 0$, $f = 1.0\text{MHz}$)	C_{ibo}	—	30	pF

SWITCHING CHARACTERISTICS

Turn–On Time Delay Time Rise Time	($V_{CC} = -30\text{V dc}$, $I_C = -150\text{mA dc}$, $I_{B1} = -15\text{mA dc}$)	t_{on} t^d t_r	— — —	45 10 40	ns
Fall Time Storage Time Turn–Off Time	($V_{CC} = -6.0\text{V dc}$, $I_C = -150\text{mA dc}$, $I_{B1} = I_{B2} = 15\text{mA dc}$)	t_f t_s t_{off}	— — —	60 225 280	ns

3. Pulse Test: Pulse Width < 300 μs , Duty Cycle < 2.0%.

4. f_T is defined as the frequency at which $|h_{fe}|$ extrapolates to unity.

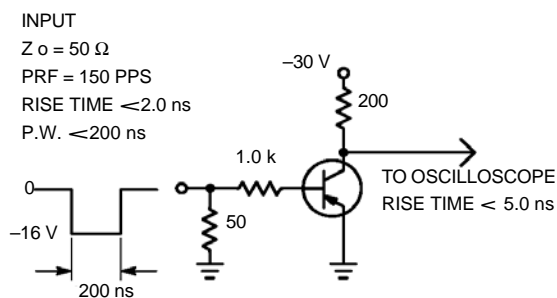

Figure 1. Delay and Rise Time Test Circuit

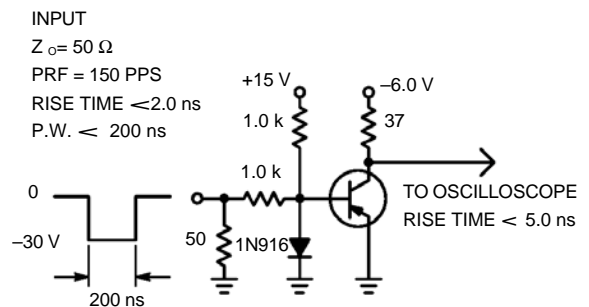

Figure 2. Storage and Fall Time Test Circuit

**LMBT2907DW1T1G, LMBT2907ADW1T1G
S-LMBT2907DW1T1G, S-LMBT2907ADW1T1G**

TYPICAL CHARACTERISTICS

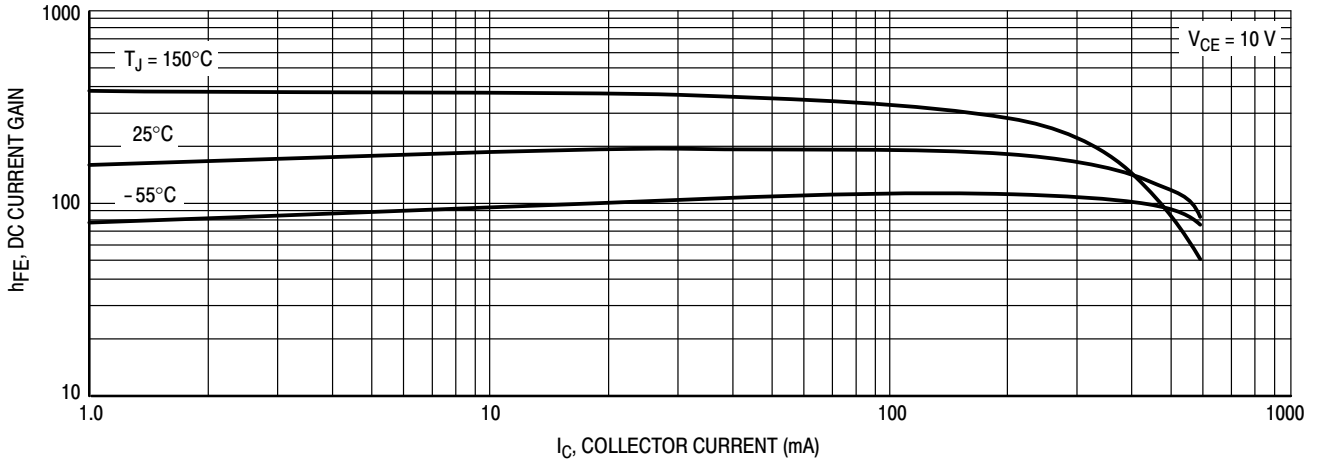

Figure 3. DC Current Gain

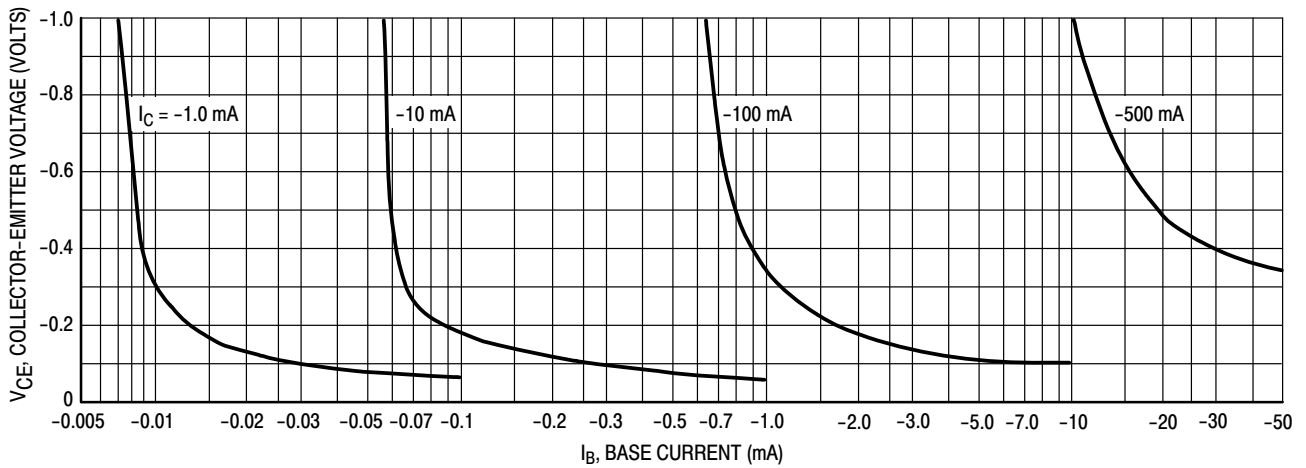

Figure 4. Collector Saturation Region

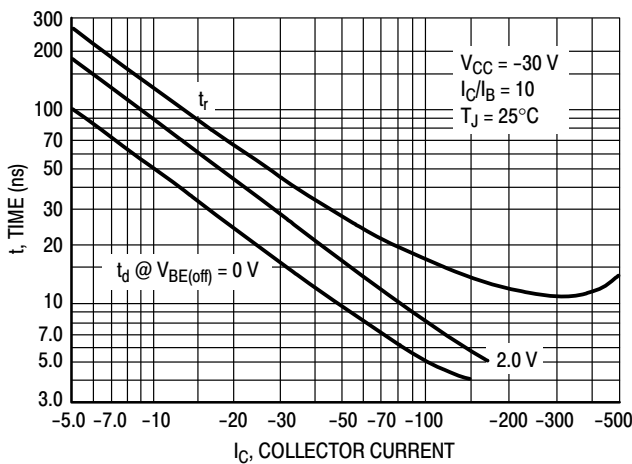

Figure 5. Turn-On Time

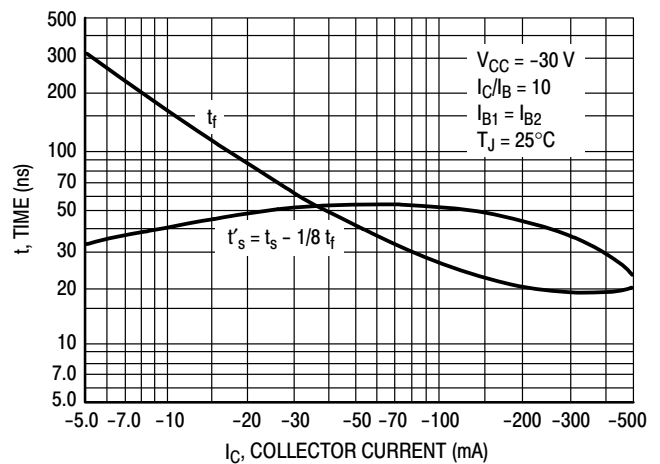

Figure 6. Turn-Off Time

**LMBT2907DW1T1G, LMBT2907ADW1T1G
S-LMBT2907DW1T1G, S-LMBT2907ADW1T1G**

TYPICAL SMALL-SIGNAL CHARACTERISTICS

NOISE FIGURE

$V_{CE} = 10 \text{ Vdc}, T_A = 25^\circ\text{C}$

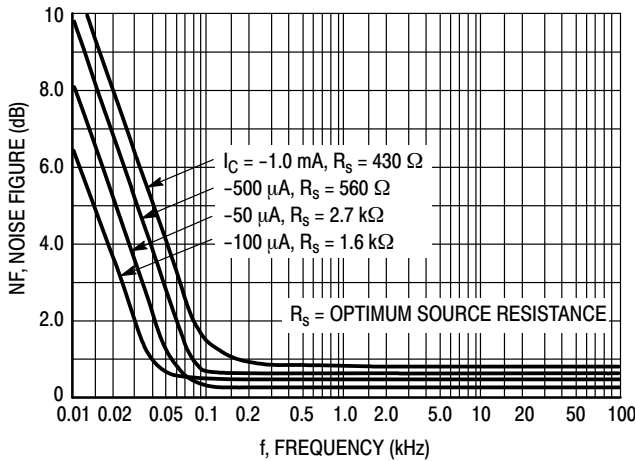

Figure 7. Frequency Effects

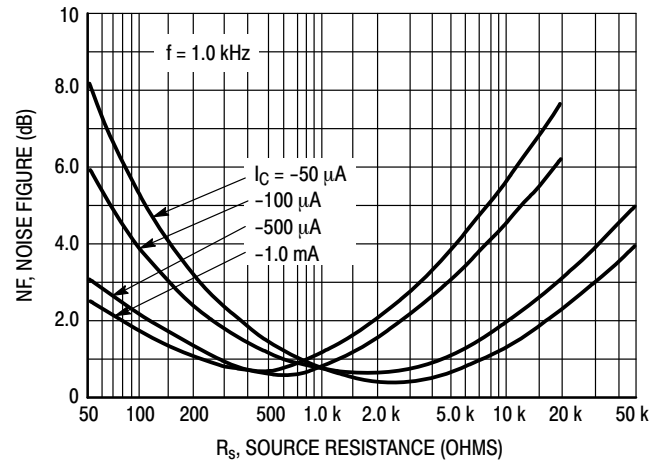

Figure 8. Source Resistance Effects

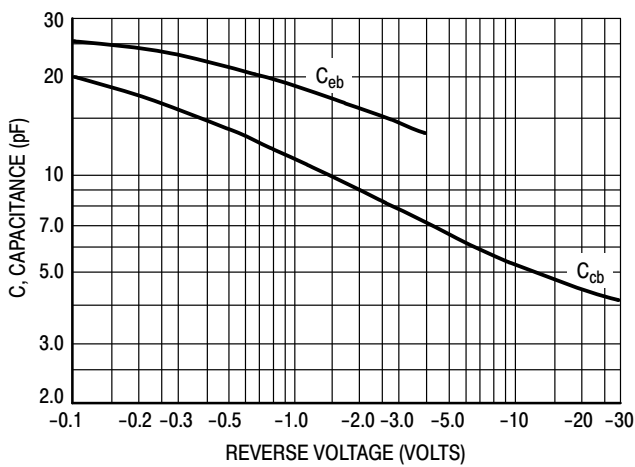

Figure 9. Capacitances

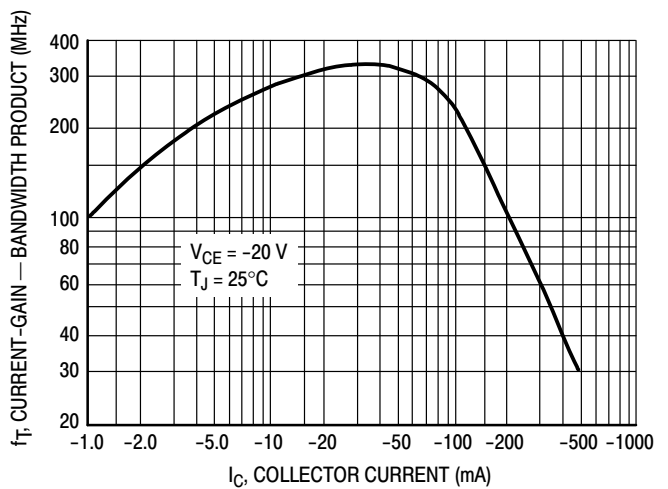

Figure 10. Current-Gain - Bandwidth Product

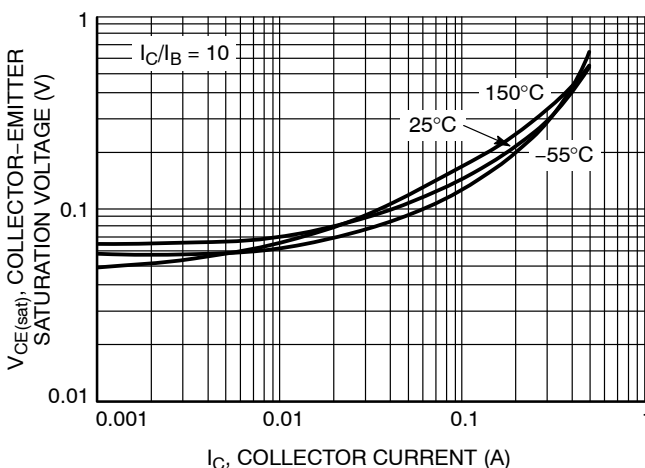

Figure 11. Collector Emitter Saturation Voltage vs. Collector Current

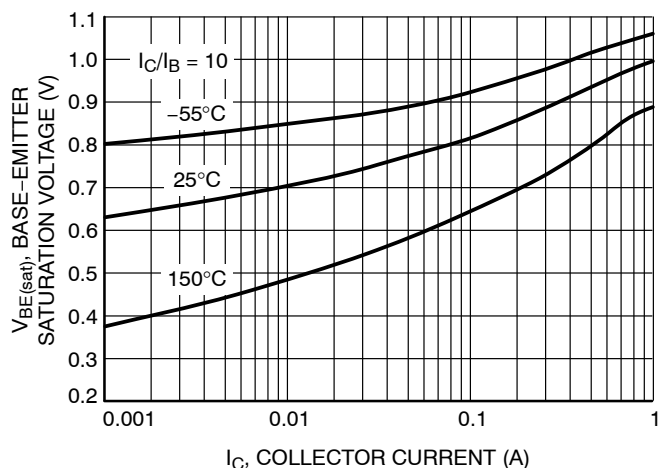

Figure 12. Base Emitter Saturation Voltage vs. Collector Current

**LMBT2907DW1T1G, LMBT2907ADW1T1G
S-LMBT2907DW1T1G, S-LMBT2907ADW1T1G**

**TYPICAL SMALL-SIGNAL Characteristics
NOISE FIGURE**

$V_{CE} = 10 \text{ Vdc}$, $T_A = 25^\circ\text{C}$

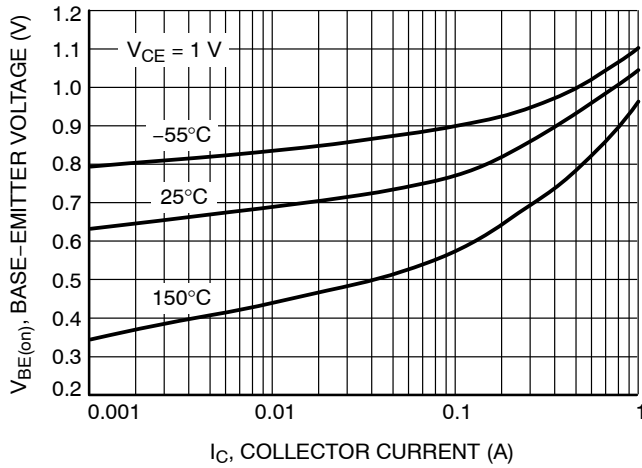

Figure 13. Base Emitter Voltage vs. Collector Current

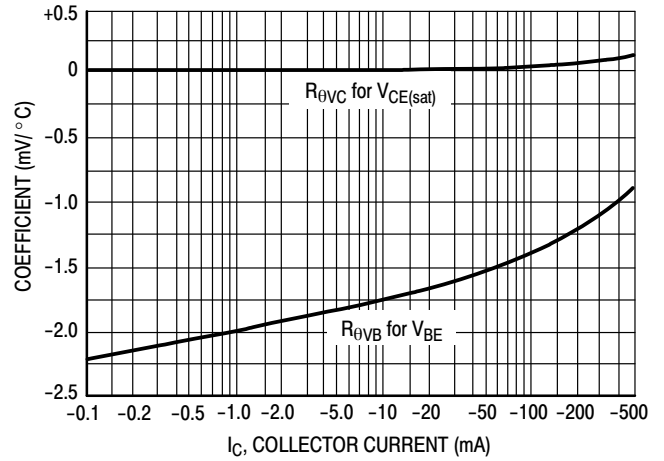

Figure 14. Temperature Coefficients

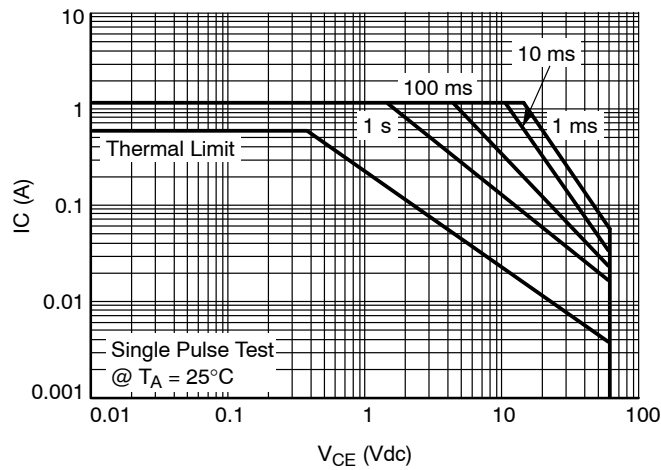
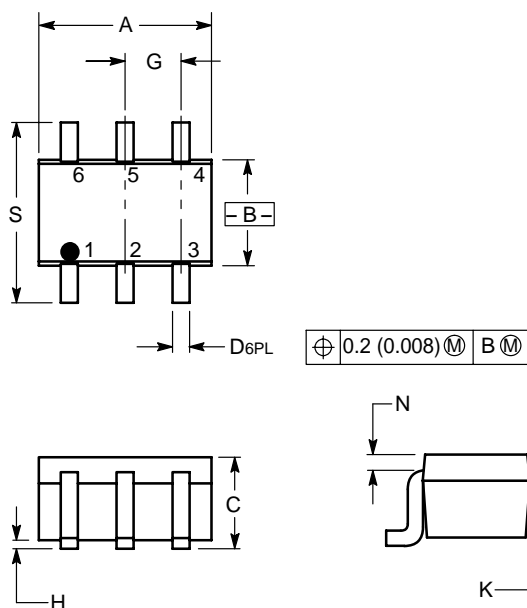

Figure 15. Safe Operating Area

**LMBT2907DW1T1G, LMBT2907ADW1T1G
S-LMBT2907DW1T1G, S-LMBT2907ADW1T1G**

SC-88/SOT-363



NOTES:

1. DIMENSIONING AND TOLERANCING PER ANSI Y14.5M, 1982.
2. CONTROLLING DIMENSION: INCH.

DIM	INCHES		MILLIMETERS	
	MIN	MAX	MIN	MAX
A	0.071	0.087	1.80	2.20
B	0.045	0.053	1.15	1.35
C	0.031	0.043	0.80	1.10
D	0.004	0.012	0.10	0.30
G	0.026 BSC		0.65 BSC	
H	---	0.004	---	0.10
J	0.004	0.010	0.10	0.25
K	0.004	0.012	0.10	0.30
N	0.008 REF		0.20 REF	
S	0.079	0.087	2.00	2.20

- PIN 1. EMITTER 2
2. BASE 2
3. COLLECTOR 1
4. EMITTER 1
5. BASE 1
6. COLLECTOR 2

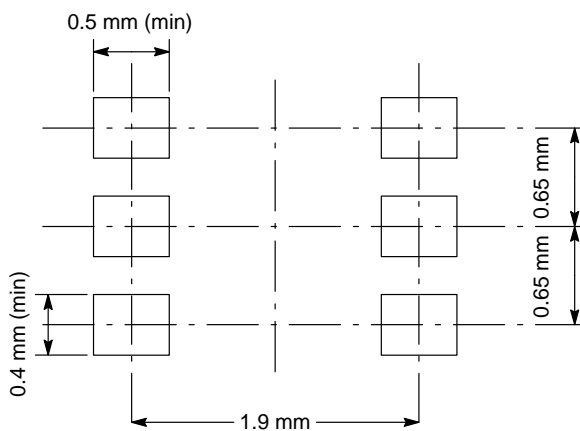

单击下面可查看定价，库存，交付和生命周期等信息

[>>LRC\(乐山无线电\)](#)