

# LTVS23H24LT1G

## S-LTVS23H24LT1G

### ESD Protection Diode

#### 1. FEATURES

- 300 watts peak pulse power.
- Low clamping voltage.
- Complies with IEC 61000-4-2 standards: Air discharge:  $\pm 30\text{kV}$   
Contact discharge:  $\pm 30\text{kV}$
- We declare that the material of product compliance with RoHS requirements and Halogen Free.
- S- Prefix for Automotive and Other Applications Requiring Unique Site and Control Change Requirements; AEC-Q101 Qualified and PPAP Capable.

#### 2. APPLICATIONS

- Cellular Handsets and Accessories
- Portable Electronics
- Industrial Controls
- Set-Top Box
- Servers, Notebook, and Desktop PC

#### 3. DEVICE MARKING AND ORDERING INFORMATION

Device	Marking	Shipping
LTVS23H24LT1G	24P	3000/Tape&Reel

#### 4. MAXIMUM RATINGS(Ta = 25°C)

Parameter	Symbol	Limits	Unit
IEC 61000-4-2 (ESD) Contact		$\pm 30$	kV
Air		$\pm 30$	
peak pulse power@8/20 $\mu\text{s}$	PPP	300	W
peak pulse current @8/20 $\mu\text{s}$	IPP	8	A
Storage Temperature Range	Tstg	-55 ~ +150	°C
Operating Temperature Range	TJ	-55 ~ +125	°C

#### 5. ELECTRICAL CHARACTERISTICS (Ta= 25°C)

Symbol	Parameter
IPP	Maximum Reverse Peak Pulse Current
VC	Clamping Voltage @ IPP
VRWM	Working Peak Reverse Voltage
IR	Maximum Reverse Leakage Current @ VRWM
VBR	Breakdown Voltage @ IT
IT	Test Current
IF	Forward Current
VF	Forward Voltage @ IF
Ppk	Peak Power Dissipation
C	Capacitance @ VR = 0 and f = 1.0 MHz

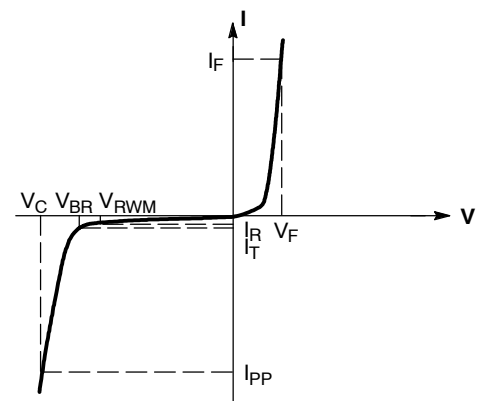
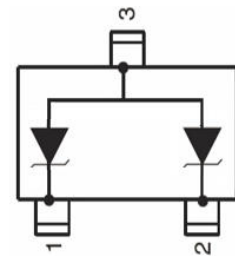
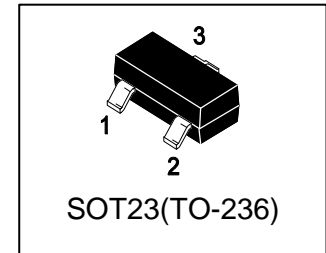

Uni-Directional TVS

**6. ELECTRICAL CHARACTERISTICS (Ta= 25°C)**

Characteristic	Symbol	Min.	Typ.	Max.	Unit
Reverse stand-off voltage	VRWM	-	-	24	V
Reverse leakage current (VRWM = 24 V, Ta= 25 °C)	IR	-	-	1	μA
Reverse breakdown voltage (IT = 1 mA)	VBR	25.6	-	-	V
Clamping Voltage (IPP = 1A (8 x 20μs pulse) (IPP = 5A (8 x 20μs pulse)	VC	-	-	30 36	V
Junction Capacitance (VR = 0V, f = 1MHz, Pin 1 to Pin2) (VR = 0V, f = 1MHz, Pin 1 to 3 and Pin 2 to3 )	CJ	-	-	30 60	pF

## 7. ELECTRICAL CHARACTERISTIC CURVES

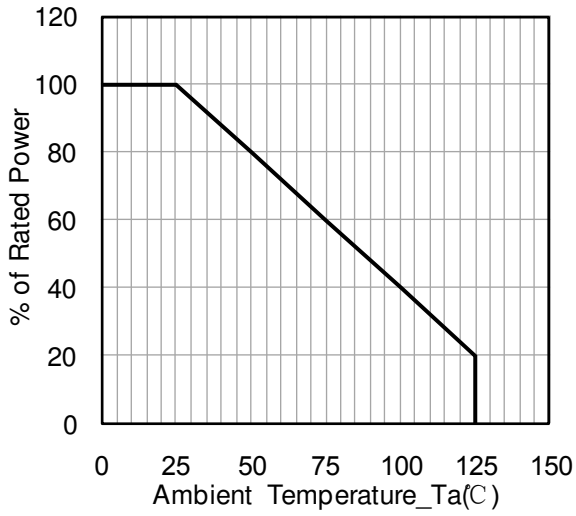

Figure 1. Power Derating Curve

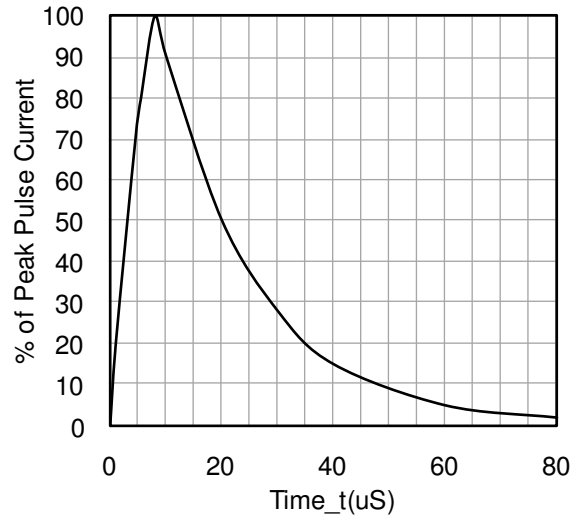

Figure 2. 8 X 20uS Pulse Waveform

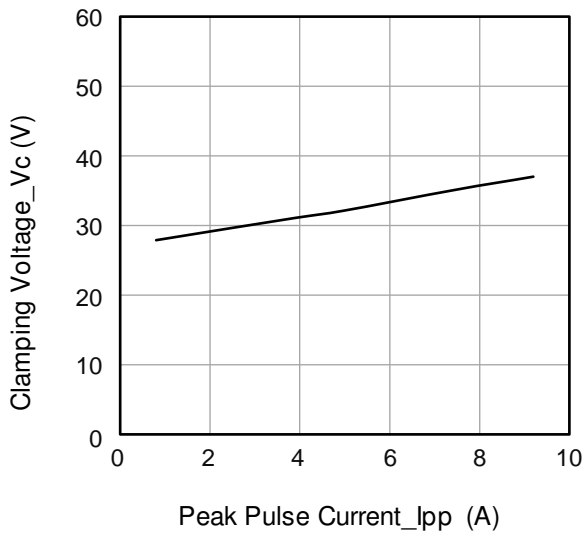

Figure 3. Clamping Voltage vs. Peak Pulse Current

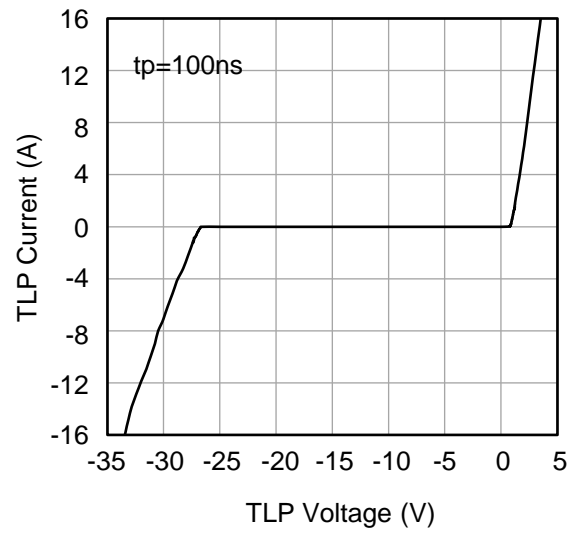
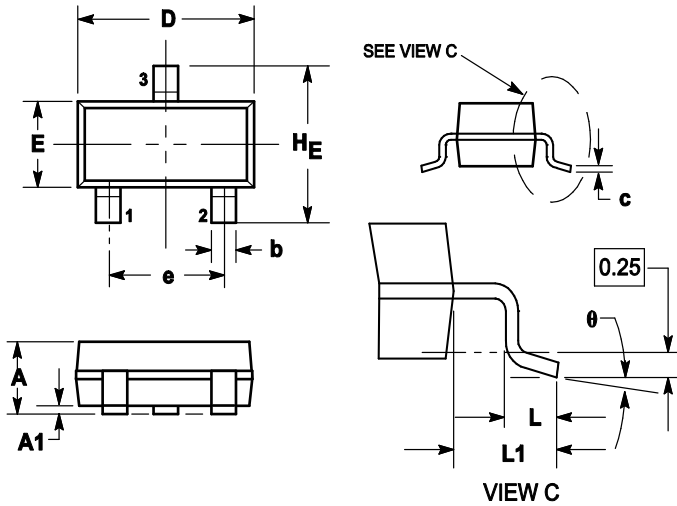

Figure 4. TLP Measurement

### 8.OUTLINE AND DIMENSIONS

Notes:

1. DIMENSIONING AND TOLERANCING PER ANSI Y14.5M, 1982.
2. CONTROLLING DIMENSION: MILLIMETERS.
3. MAXIMUM LEAD THICKNESS INCLUDES LEAD FINISH. MINIMUM LEAD THICKNESS IS THE MINIMUM THICKNESS OF BASE MATERIAL.
4. DIMENSIONS D AND E DO NOT INCLUDE MOLD FLASH, PROTRUSIONS OR GATE BURRS.



DIM	MILLIMETERS			INCHES		
	MIN	NOM	MAX	MIN	NOM	MAX
A	0.89	1	1.11	0.035	0.04	0.044
A1	0.01	0.06	0.1	0.001	0.002	0.004
b	0.37	0.44	0.5	0.015	0.018	0.02
c	0.09	0.13	0.18	0.003	0.005	0.007
D	2.80	2.9	3.04	0.11	0.114	0.12
E	1.20	1.3	1.4	0.047	0.051	0.055
e	1.78	1.9	2.04	0.07	0.075	0.081
L	0.10	0.2	0.3	0.004	0.008	0.012
L1	0.35	0.54	0.69	0.014	0.021	0.029
HE	2.10	2.4	2.64	0.083	0.094	0.104
θ	0°	---	10°	0°	---	10°

### 9.SOLDERING FOOTPRINT

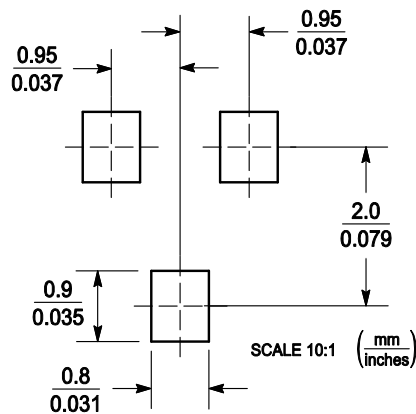

## DISCLAIMER

- Before you use our Products, you are requested to carefully read this document and fully understand its contents. LRC shall not be in any way responsible or liable for failure, malfunction or accident arising from the use of any LRC's Products against warning, caution or note contained in this document.
- All information contained in this document is current as of the issuing date and subject to change without any prior notice. Before purchasing or using LRC's Products, please confirm the latest information with a LRC sales representative.

单击下面可查看定价，库存，交付和生命周期等信息

[>>LRC\(乐山无线电\)](#)