

# Dual General Purpose Transistors

## NPN Silicon

We declare that material of product compliance with ROHS requirements.

S- Prefix for Automotive and Other Applications Requiring Unique Site and Control Change Requirements;  
AEC-Q101 Qualified and PPAP Capable.

**LMBT2222ADW1T1G**  
**S-LMBT2222ADW1T1G**

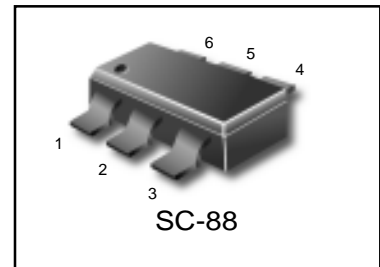

### MAXIMUM RATINGS

Rating	Symbol	Value	Unit
Collector-Emitter Voltage	$V_{CEO}$	40	Vdc
Collector-Base Voltage	$V_{CBO}$	75	Vdc
Emitter-Base Voltage	$V_{EBO}$	6.0	Vdc
Collector Current – Continuous	$I_C$	600	mAdc

### THERMAL CHARACTERISTICS

Characteristic	Symbol	Max	Unit
Total Package Dissipation (Note 1) $T_A = 25^\circ\text{C}$	$P_D$	150	mW
Thermal Resistance, Junction to Ambient	$R_{\theta JA}$	833	$^\circ\text{C/W}$
Junction and Storage Temperature	$T_J, T_{stg}$	-55 to +150	$^\circ\text{C}$

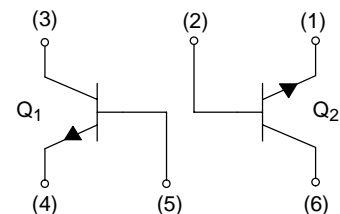

### ORDERING INFORMATION

Device	Marking	Shipping
LMBT2222ADW1T1G S-LMBT2222ADW1T1G	XX	3000/Tape & Reel
LMBT2222ADW1T3G S-LMBT2222ADW1T3G	XX	10000/Tape & Reel

LMBT2222ADW1T1G;S-LMBT2222ADW1T1G

**ELECTRICAL CHARACTERISTICS** ( $T_A = 25^\circ\text{C}$  unless otherwise noted)

Characteristic	Symbol	Min	Max	Unit
<b>OFF CHARACTERISTICS</b>				
Collector–Emitter Breakdown Voltage ( $I_C = 10\text{ mA}$ , $I_B = 0$ )	$V_{(BR)CEO}$	40	–	Vdc
Collector–Base Breakdown Voltage ( $I_C = 10\text{ }\mu\text{A}$ , $I_E = 0$ )	$V_{(BR)CBO}$	75	–	Vdc
Emitter–Base Breakdown Voltage ( $I_E = 10\text{ }\mu\text{A}$ , $I_C = 0$ )	$V_{(BR)EBO}$	6.0	–	Vdc
Collector Cutoff Current ( $V_{CE} = 60\text{ Vdc}$ , $V_{EB(off)} = 3.0\text{ Vdc}$ )	$I_{CEX}$	–	10	nAdc
Collector Cutoff Current ( $V_{CB} = 60\text{ Vdc}$ , $I_E = 0$ ) ( $V_{CB} = 60\text{ Vdc}$ , $I_E = 0$ , $T_A = 125^\circ\text{C}$ )	$I_{CBO}$	– –	0.01 10	$\mu\text{Adc}$
Emitter Cutoff Current ( $V_{EB} = 3.0\text{ Vdc}$ , $I_C = 0$ )	$I_{EBO}$	–	100	nAdc
Base Cutoff Current ( $V_{CE} = 60\text{ Vdc}$ , $V_{EB(off)} = 3.0\text{ Vdc}$ )	$I_{BL}$	–	20	nAdc

**ON CHARACTERISTICS**

DC Current Gain ( $I_C = 0.1\text{ mA}$ , $V_{CE} = 10\text{ Vdc}$ ) ( $I_C = 1.0\text{ mA}$ , $V_{CE} = 10\text{ Vdc}$ ) ( $I_C = 10\text{ mA}$ , $V_{CE} = 10\text{ Vdc}$ ) ( $I_C = 10\text{ mA}$ , $V_{CE} = 10\text{ Vdc}$ , $T_A = -55^\circ\text{C}$ ) ( $I_C = 150\text{ mA}$ , $V_{CE} = 10\text{ Vdc}$ ) (Note 2) ( $I_C = 150\text{ mA}$ , $V_{CE} = 1.0\text{ Vdc}$ ) (Note 2) ( $I_C = 500\text{ mA}$ , $V_{CE} = 10\text{ Vdc}$ ) (Note 2)	$h_{FE}$	35 50 75 35 100 50 40	– – – – 300 – –	–
Collector–Emitter Saturation Voltage (Note 2) ( $I_C = 150\text{ mA}$ , $I_B = 15\text{ mA}$ ) ( $I_C = 500\text{ mA}$ , $I_B = 50\text{ mA}$ )	$V_{CE(sat)}$	– –	0.3 1.0	Vdc
Base–Emitter Saturation Voltage (Note 2) ( $I_C = 150\text{ mA}$ , $I_B = 15\text{ mA}$ ) ( $I_C = 500\text{ mA}$ , $I_B = 50\text{ mA}$ )	$V_{BE(sat)}$	0.6 –	1.2 2.0	Vdc

 2. Pulse Test: Pulse Width  $\leq 300\text{ }\mu\text{s}$ , Duty Cycle  $\leq 2.0\%$ .

**SMALL-SIGNAL CHARACTERISTICS**

Current-Gain – Bandwidth Product (Note 3) ( $I_C = 20 \text{ mAdc}$ , $V_{CE} = 20 \text{ Vdc}$ , $f = 100 \text{ MHz}$ )	$f_T$	300	–	MHz
Output Capacitance ( $V_{CB} = 10 \text{ Vdc}$ , $I_E = 0$ , $f = 1.0 \text{ MHz}$ )	$C_{obo}$	–	8.0	pF
Input Capacitance ( $V_{EB} = 0.5 \text{ Vdc}$ , $I_C = 0$ , $f = 1.0 \text{ MHz}$ )	$C_{ibo}$	–	25	pF
Input Impedance ( $I_C = 1.0 \text{ mAdc}$ , $V_{CE} = 10 \text{ Vdc}$ , $f = 1.0 \text{ kHz}$ ) ( $I_C = 10 \text{ mAdc}$ , $V_{CE} = 10 \text{ Vdc}$ , $f = 1.0 \text{ kHz}$ )	$h_{ie}$	2.0 0.25	8.0 1.25	k $\Omega$
Voltage Feedback Ratio ( $I_C = 1.0 \text{ mAdc}$ , $V_{CE} = 10 \text{ Vdc}$ , $f = 1.0 \text{ kHz}$ ) ( $I_C = 10 \text{ mAdc}$ , $V_{CE} = 10 \text{ Vdc}$ , $f = 1.0 \text{ kHz}$ )	$h_{re}$	– –	8.0 4.0	$\times 10^{-4}$
Small-Signal Current Gain ( $I_C = 1.0 \text{ mAdc}$ , $V_{CE} = 10 \text{ Vdc}$ , $f = 1.0 \text{ kHz}$ ) ( $I_C = 10 \text{ mAdc}$ , $V_{CE} = 10 \text{ Vdc}$ , $f = 1.0 \text{ kHz}$ )	$h_{fe}$	50 75	300 375	–
Output Admittance ( $I_C = 1.0 \text{ mAdc}$ , $V_{CE} = 10 \text{ Vdc}$ , $f = 1.0 \text{ kHz}$ ) ( $I_C = 10 \text{ mAdc}$ , $V_{CE} = 10 \text{ Vdc}$ , $f = 1.0 \text{ kHz}$ )	$h_{oe}$	5.0 25	35 200	$\mu\text{mhos}$
Collector Base Time Constant ( $I_E = 20 \text{ mAdc}$ , $V_{CB} = 20 \text{ Vdc}$ , $f = 31.8 \text{ MHz}$ )	$r_b, C_C$	–	150	ps
Noise Figure ( $I_C = 100 \mu\text{Adc}$ , $V_{CE} = 10 \text{ Vdc}$ , $R_S = 1.0 \text{ k}\Omega$ , $f = 1.0 \text{ kHz}$ )	NF	–	4.0	dB

**SWITCHING CHARACTERISTICS**

Delay Time	( $V_{CC} = 30 \text{ Vdc}$ , $V_{BE(\text{off})} = -0.5 \text{ Vdc}$ , $I_C = 150 \text{ mAdc}$ , $I_{B1} = 15 \text{ mAdc}$ )	$t_d$	–	10	ns
Rise Time		$t_r$	–	25	
Storage Time	( $V_{CC} = 30 \text{ Vdc}$ , $I_C = 150 \text{ mAdc}$ , $I_{B1} = I_{B2} = 15 \text{ mAdc}$ )	$t_s$	–	225	ns
Fall Time		$t_f$	–	60	

3.  $f_T$  is defined as the frequency at which  $|h_{fe}|$  extrapolates to unity.

LMBT2222ADW1T1G;S-LMBT2222ADW1T1G

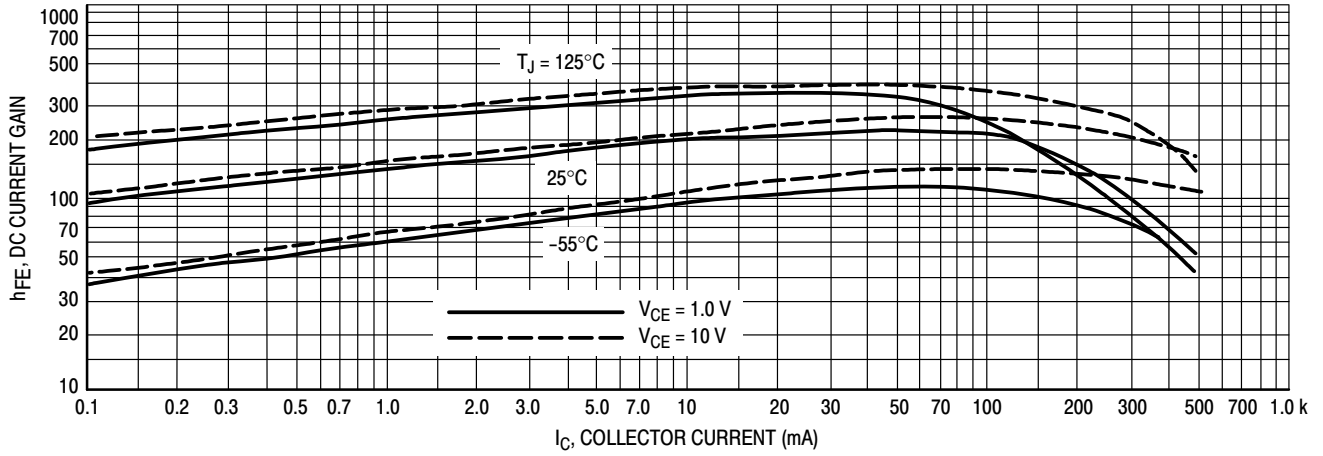

Figure 1. DC Current Gain

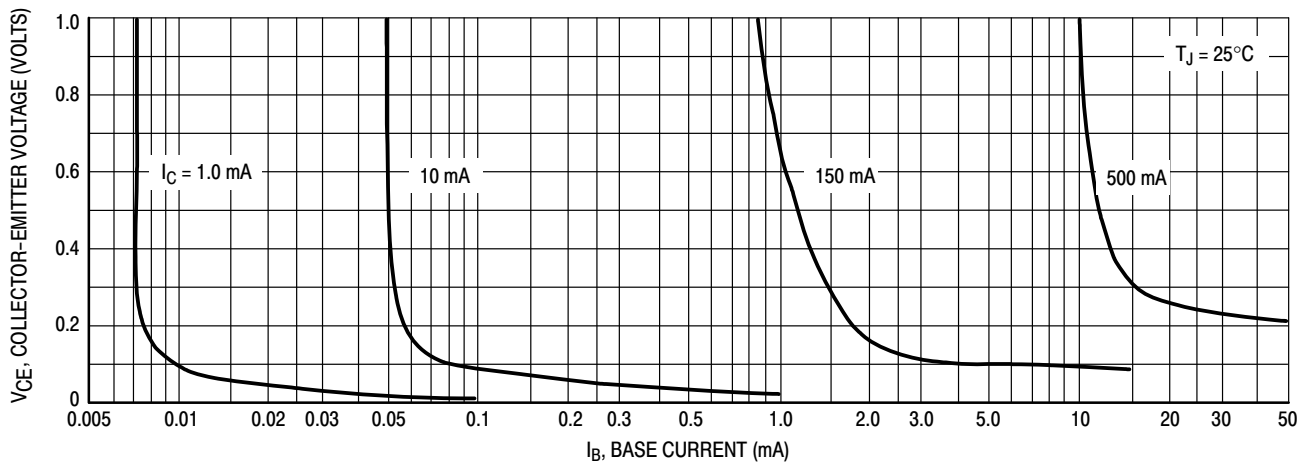

Figure 2. Collector Saturation Region

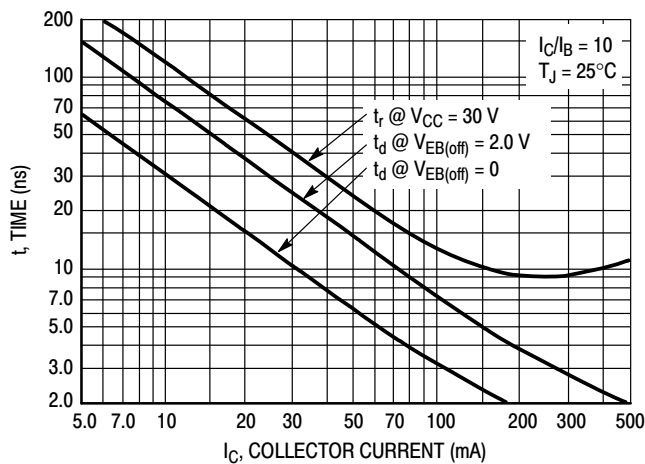

Figure 3. Turn-On Time

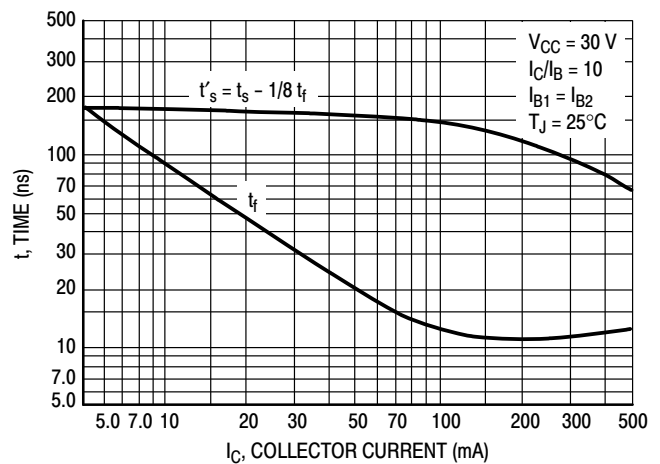

Figure 4. Turn-Off Time

LMBT2222ADW1T1G;S-LMBT2222ADW1T1G

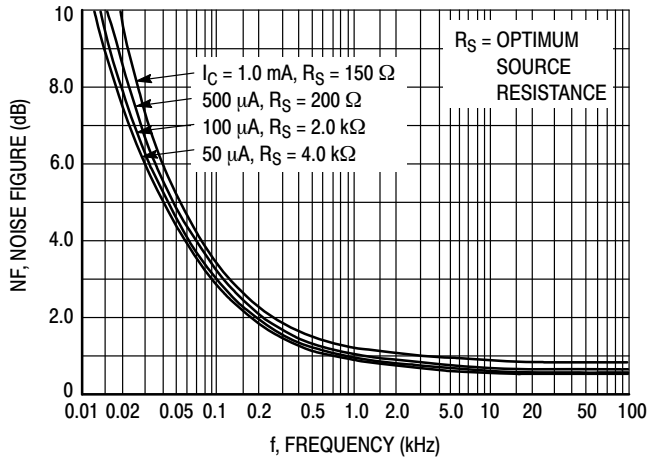

Figure 5. Frequency Effects

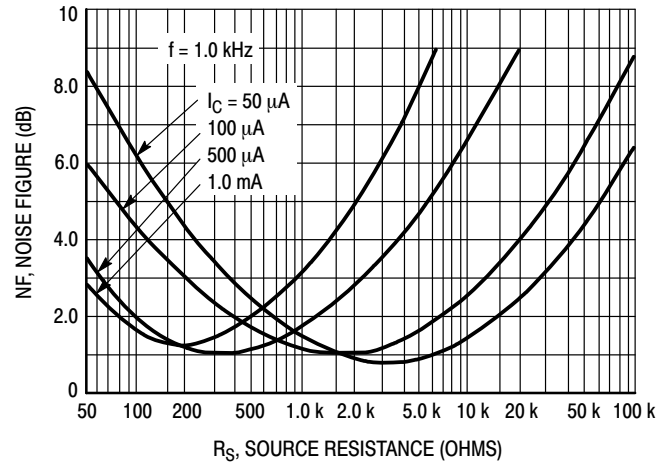

Figure 6. Source Resistance Effects

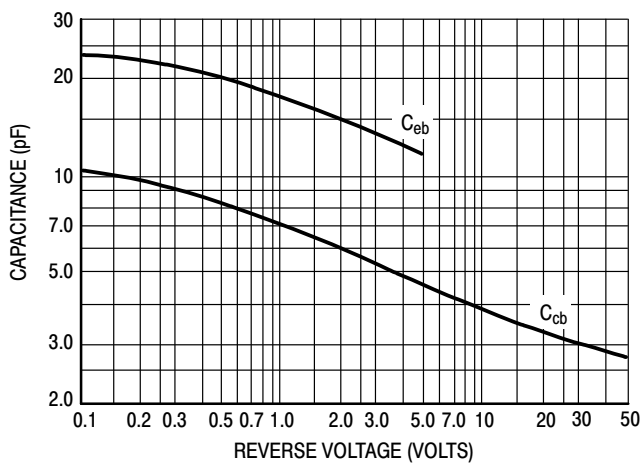

Figure 7. Capacitances

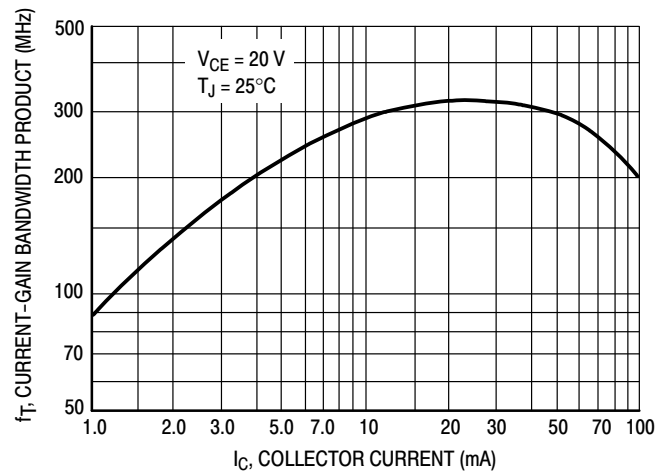

Figure 8. Current-Gain Bandwidth Product

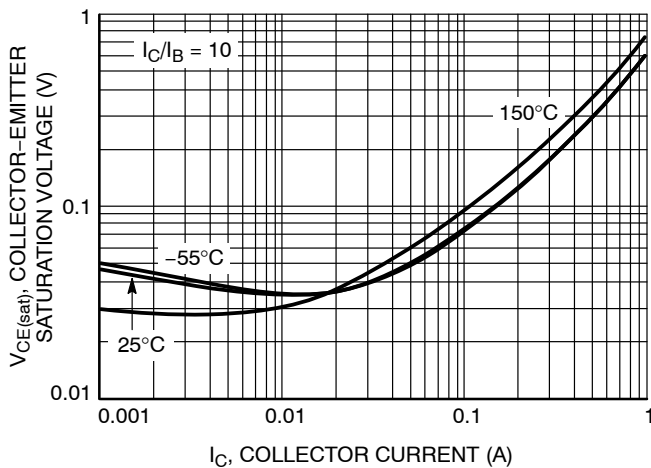

Figure 9. Collector Emitter Saturation Voltage vs. Collector Current

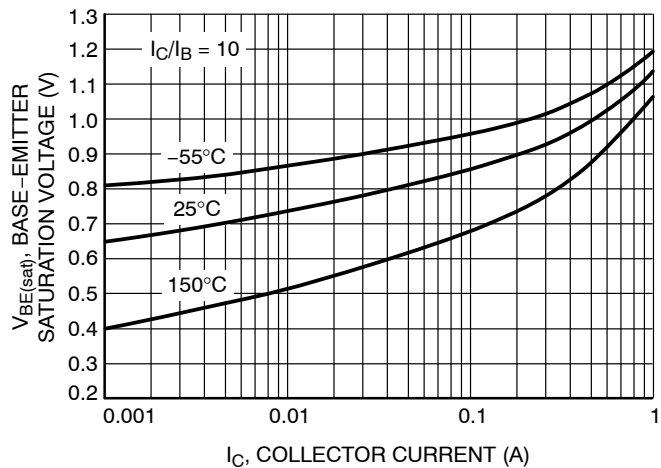

Figure 10. Base Emitter Saturation Voltage vs. Collector Current

LMBT2222ADW1T1G;S-LMBT2222ADW1T1G

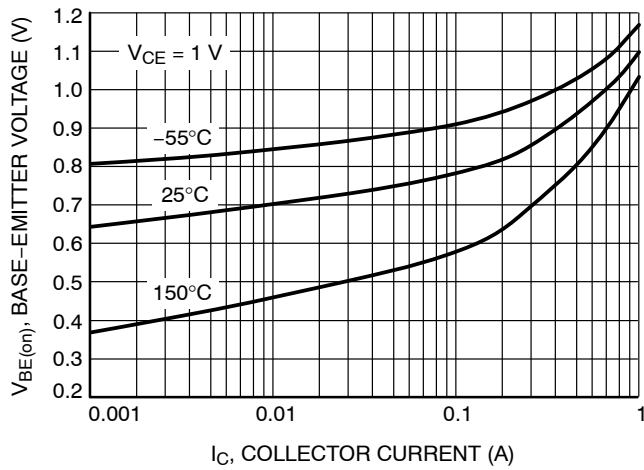

Figure 11. Base Emitter Voltage vs. Collector Current

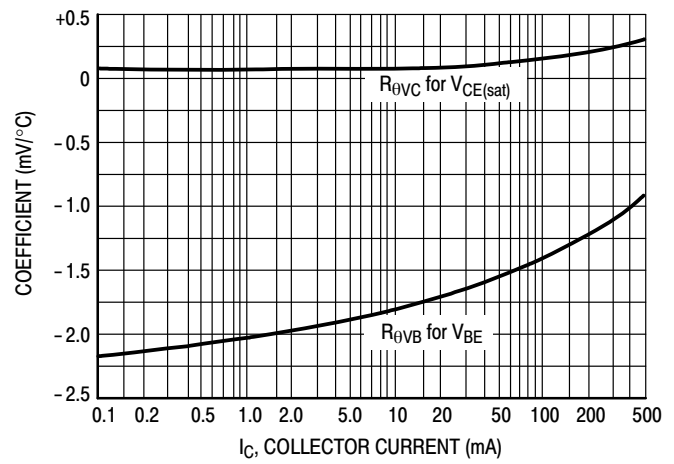

Figure 12. Temperature Coefficients

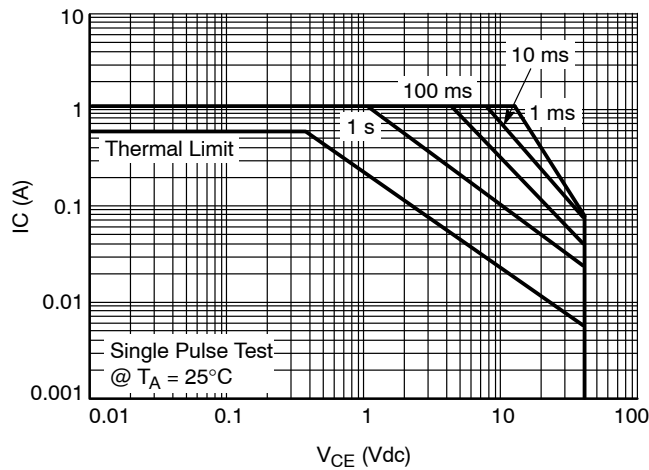
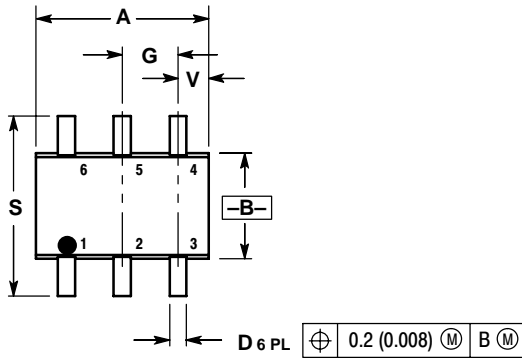
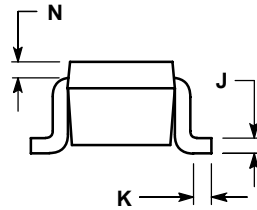
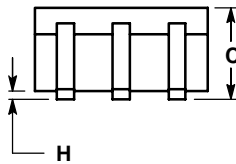

Figure 13. Safe Operating Area

LMBT2222ADW1T1G;S-LMBT2222ADW1T1G

**SOT-363/SC-88**

DIM	INCHES		MILLIMETERS	
	MIN	MAX	MIN	MAX
A	0.071	0.087	1.80	2.20
B	0.045	0.053	1.15	1.35
C	0.031	0.043	0.80	1.10
D	0.004	0.012	0.10	0.30
G	0.026 BSC		0.65 BSC	
H	---	0.004	---	0.10
J	0.004	0.010	0.10	0.25
K	0.004	0.012	0.10	0.30
N	0.008 REF		0.20 REF	
S	0.079	0.087	2.00	2.20
V	0.012	0.016	0.30	0.40



单击下面可查看定价，库存，交付和生命周期等信息

[>>LRC\(乐山无线电\)](#)