

# LP2511T1G

60V P-Channel (D-S) MOSFET

## 1. FEATURES

- Low RDS(ON) trench technology.
- Low thermal impedance.
- Fast switching speed.
- We declare that the material of product compliance with RoHS requirements and Halogen Free.

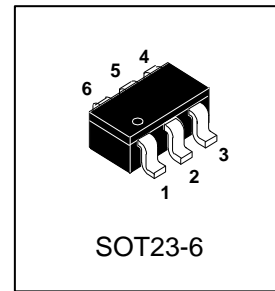

## 2. APPLICATIONS

- Load Switches
- DC/DC Conversion
- Motor Drives

## 3. DEVICE MARKING AND ORDERING INFORMATION

Device	Marking	Shipping
LP2511T1G	P11	3000/Tape&Reel

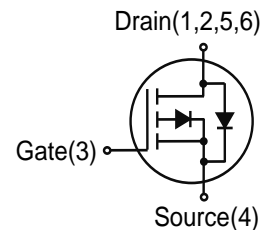

## 4. MAXIMUM RATINGS(Ta = 25°C)

Parameter	Symbol	Limits	Unit	
Drain-Source Voltage	VDS	-60	V	
Gate-Source Voltage	VGS	±20		
Continuous Drain Current (Note 1)	ID	-3.5	A	
Pulsed Drain Current (Note 2)	IDM	-14		
Avalanche Current	IAS	14		
Avalanche energy(L=0.1mH)	EAS	9.8	mJ	
Power Dissipation (Note 1)	PD	TA = 25°C	1.25	W
		TA = 70°C	0.9	
Operating Junction and Storage Temperature Range	TJ , Tstg	-55~+150	°C	

## 5. THERMAL CHARACTERISTICS

Parameter	Symbol	Limits	Unit
Thermal Resistance,Junction-to-Ambient (Note 1)	RθJA	100	°C/W
Thermal Resistance,Junction-to-Ambient (Note 3)	RθJA	150	°C/W

- 1.Surface mounted on "1.5 x 1.5" FR4 board using 1 sq in pad, 2 oz Cu.
- 2.Pulse width limited by maximum junction temperature.
- 3.Surface mounted on FR4 board using the minimum recommended pad size.

**6. ELECTRICAL CHARACTERISTICS (Ta= 25°C)**

Characteristic	Symbol	Min.	Typ.	Max.	Unit
<b>STATIC</b>					
Drain–Source Breakdown Voltage (VGS = 0, ID = -250μA)	VBRDSS	-60	-	-	V
Gate–Source Threshold Voltage (VGS = VDS , ID = -250μA)	VGS(th)	-1	-	-3	V
Gate–to–Source Leakage Current (VDS = 0 V, VGS = ±20 V)	IGSS	-	-	±10	μA
Zero Gate Voltage Drain Current (VDS = -48 V, VGS = 0 V) (VDS = -48 V, VGS = 0 V, TJ = 55°C)	IDSS	-	-	-1 -25	μA
Static Drain–Source On–State Resistance(Note 4) (VGS = -10 V, ID = -1.5 A ) (VGS = -4.5 V, ID = -1.5 A )	RDS(on)	-	-	92 110	mΩ
Forward Diode Voltage (IS = -2.1 A, VGS = 0 V)	VSD	-	-	-1.2	V
<b>DYNAMIC</b>					
Total Gate Charge	(VDS = -30 V, VGS = -4.5 V, ID = -4 A)	Qg	-	8.8	nC
Gate–to–Source Charge		Qgs	-	2.3	
Gate–to–Drain Charge		Qgd	-	3.4	
Turn–On Delay Time	(VDS=-30 V, RL=7.5 Ω, ID=-4 A, VGEN =-10 V, RGEN= 6 Ω)	td(on)	-	8.7	ns
Turn–On Rise Time		tr	-	9.2	
Turn–Off Delay Time		td(off)	-	45.2	
Turn–Off Fall Time		tf	-	18.2	
Input Capacitance	(VDS = -15 V, VGS = 0 V, f = 1 MHz)	Ciss	-	1086	pF
Output Capacitance		Coss	-	68	
Reverse Transfer Capacitance		Crss	-	66	

4.Pulse Test: Pulse Width ≤300 μs, Duty Cycle ≤2.0%.

**7. ELECTRICAL CHARACTERISTICS CURVES**

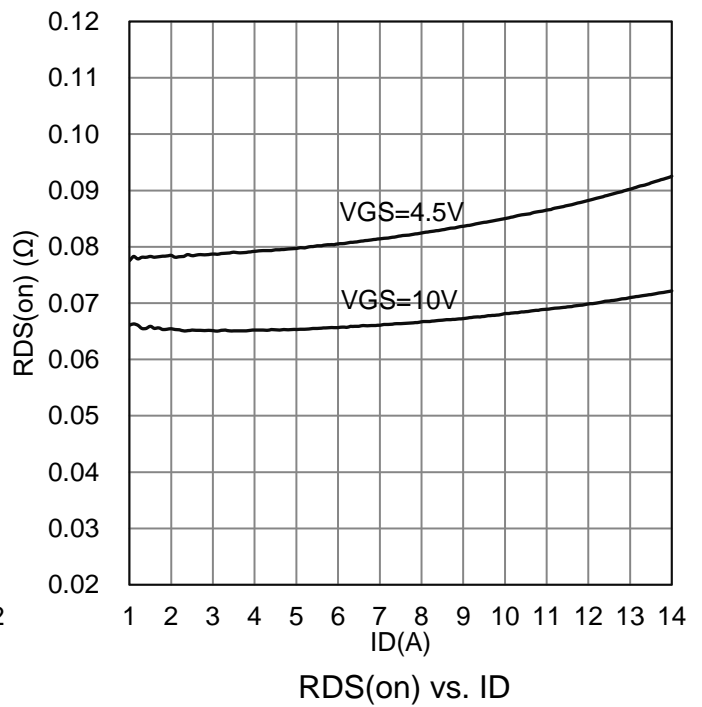
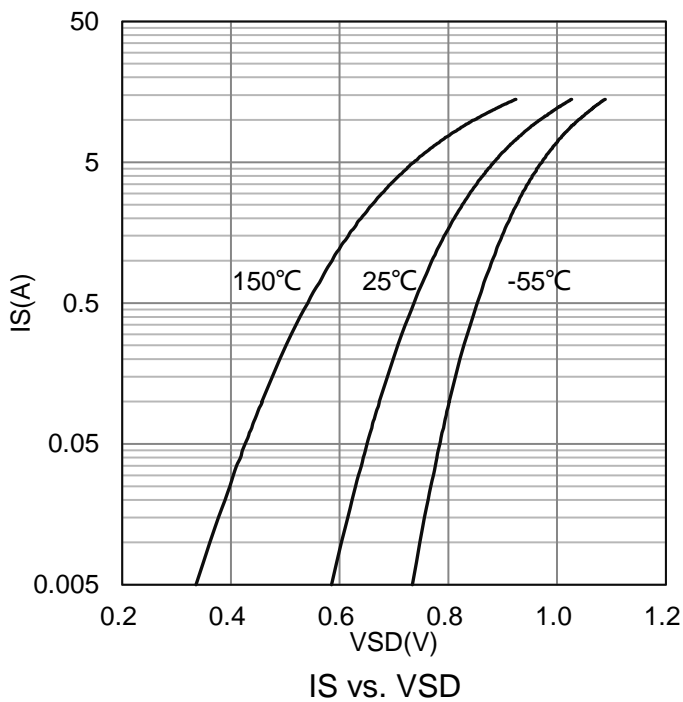
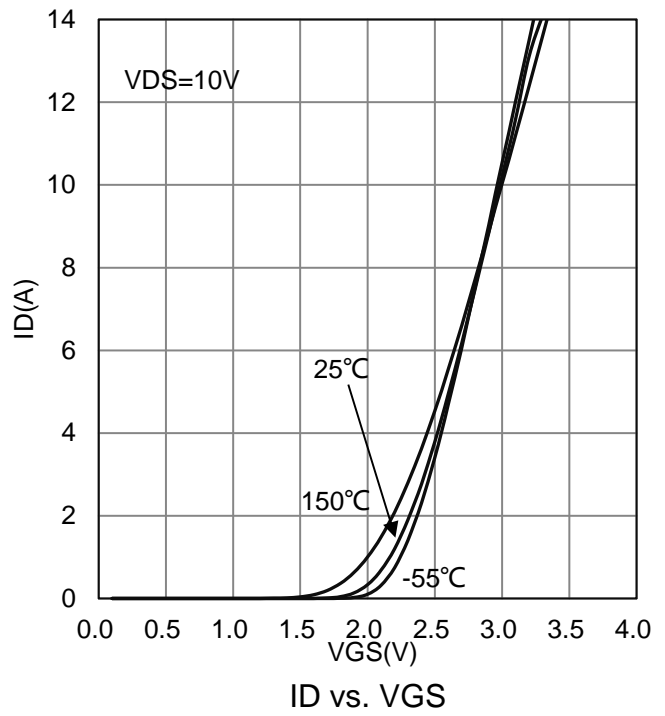
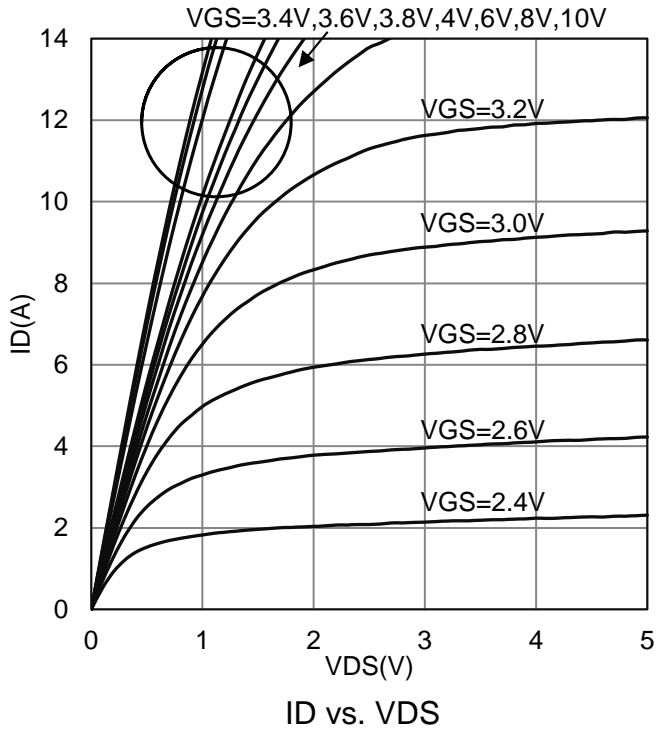

**7. ELECTRICAL CHARACTERISTICS CURVES(Con.)**

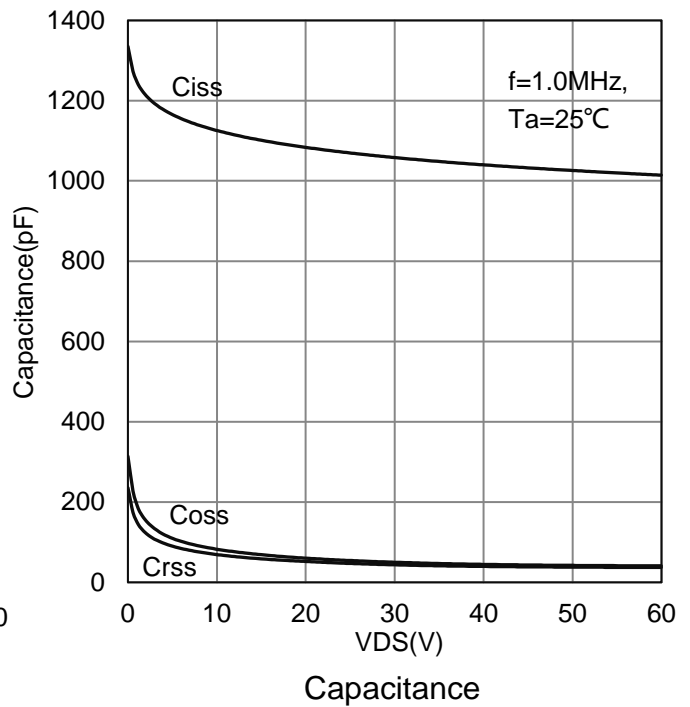
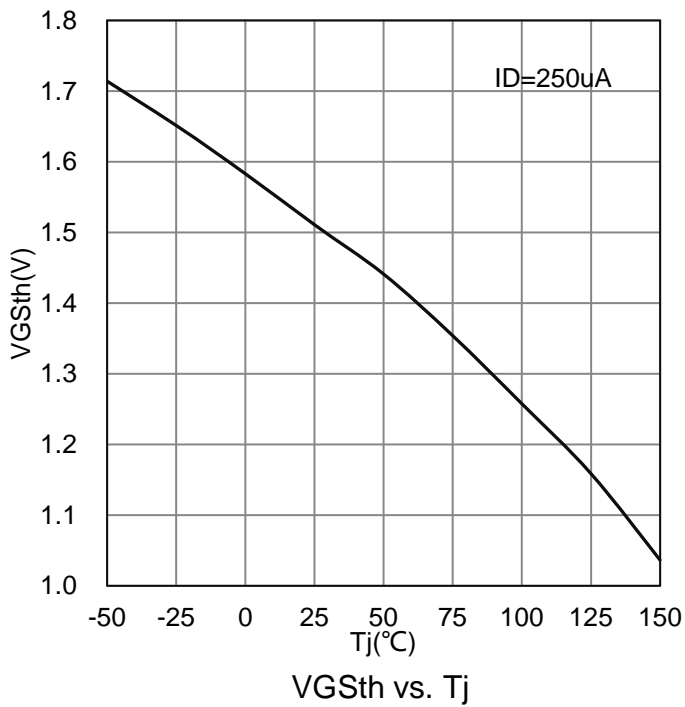
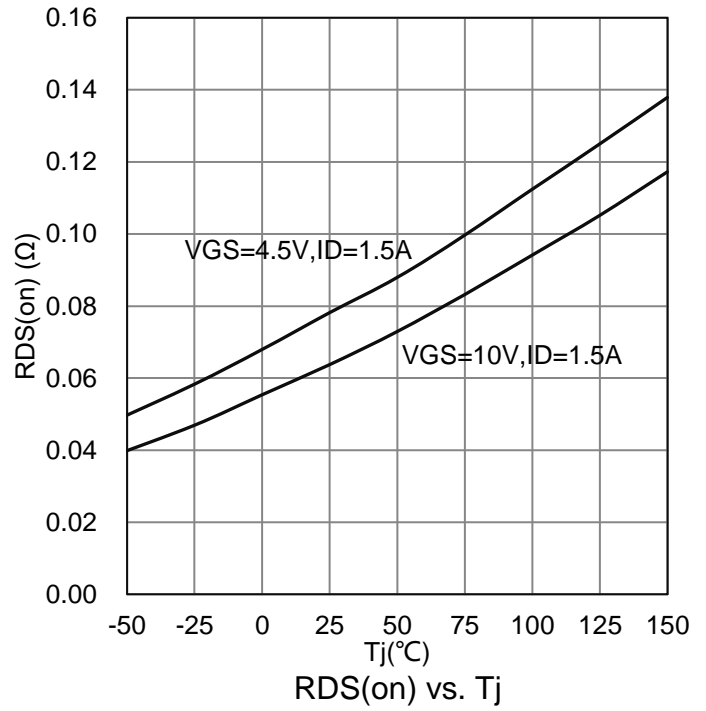
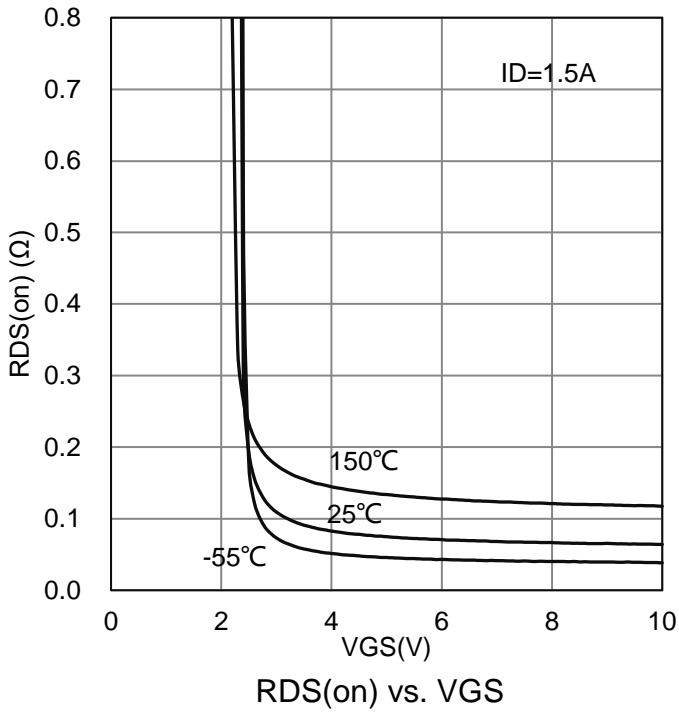

7. ELECTRICAL CHARACTERISTICS CURVES(Con.)

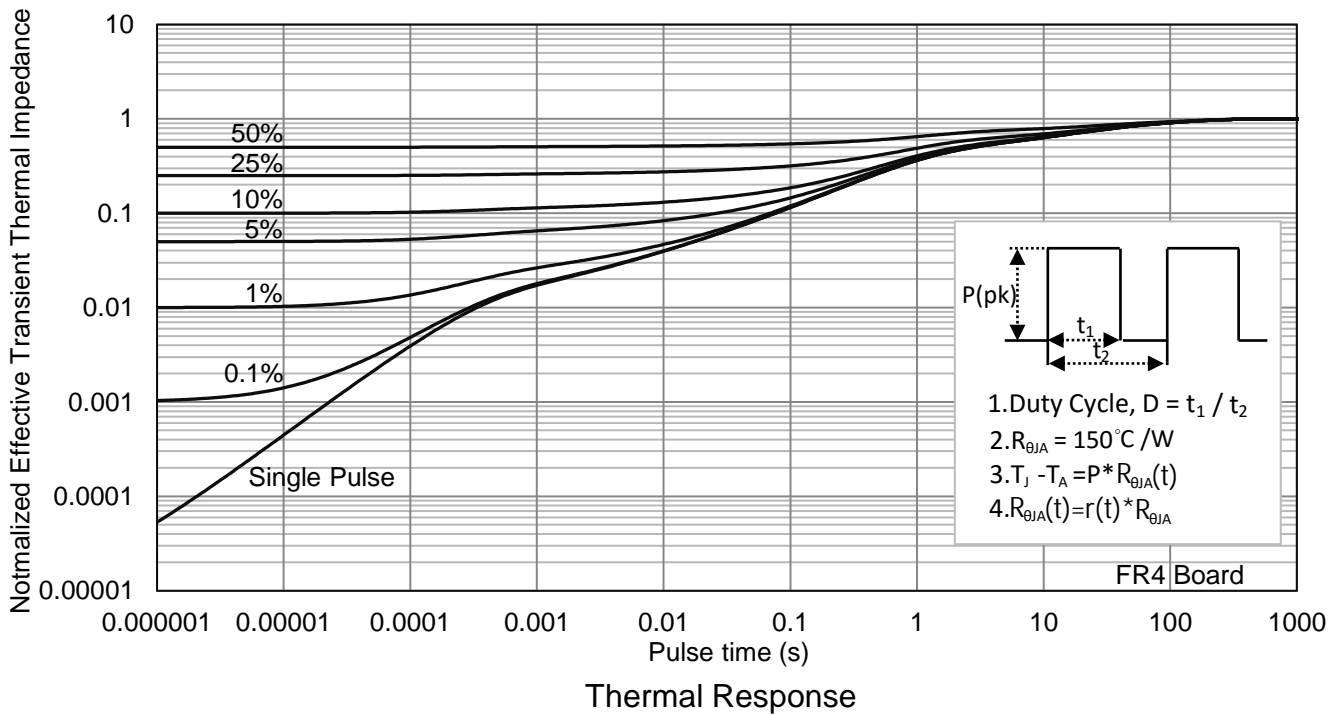
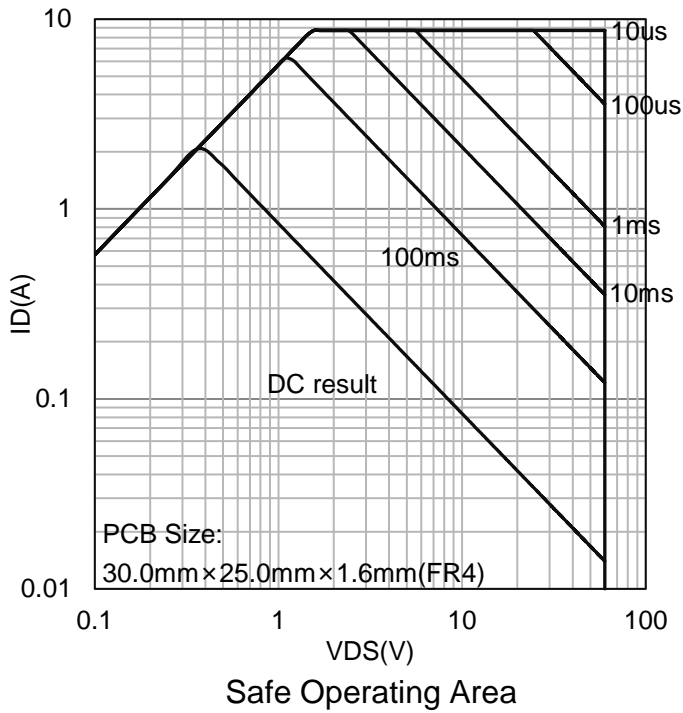

### 8. OUTLINE AND DIMENSIONS

SOT23-6

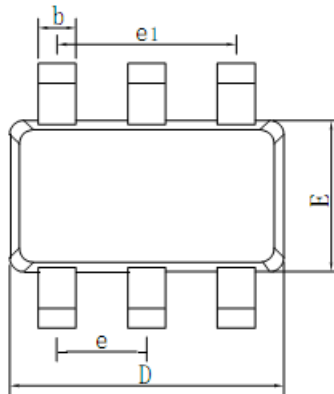
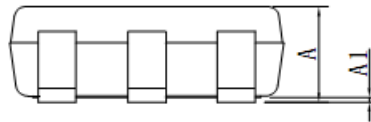
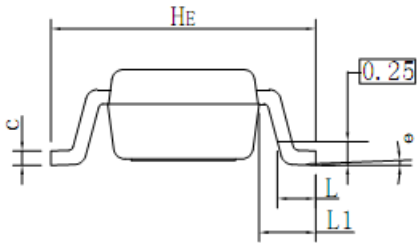

SOT23-6			
DIM	MIN	NOR	MAX
A	0.90	1.00	1.10
A1	0.01	0.06	0.10
b	0.25	0.40	0.50
c	0.10	0.17	0.26
D	2.80	2.90	3.10
E	1.30	1.60	1.70
e	0.85	0.95	1.05
e1	1.80	1.90	2.00
L	0.20	0.40	0.60
L1	0.60REF		
HE	2.50	2.80	3.00
θ	0°	-	10°

### 9. SOLDERING FOOTPRINT

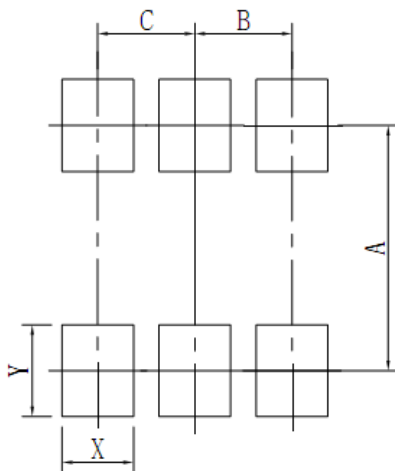

SOT23-6	
DIM	(mm)
X	0.70
Y	0.90
A	2.40
B	0.95
C	0.95

## DISCLAIMER

- Before you use our Products, you are requested to carefully read this document and fully understand its contents. LRC shall not be in any way responsible or liable for failure, malfunction or accident arising from the use of any LRC's Products against warning, caution or note contained in this document.
- All information contained in this document is current as of the issuing date and subject to change without any prior notice. Before purchasing or using LRC's Products, please confirm the latest information with a LRC sales representative.

单击下面可查看定价，库存，交付和生命周期等信息

[>>LRC\(乐山无线电\)](#)