

S-LN01N100TZHG

100V N-Channel Power MOSFET

1. FEATURES

- Low RDS(on) trench technology
- Low thermal impedance
- Fast switching speed
- We declare that the material of product compliance with RoHS requirements and Halogen Free.
- S-prefix for automotive and other applications requiring unique site and control change requirements; AEC-Q101 qualified and PPAP capable.

2. APPLICATIONS

- Power Routing
- DC/DC Conversion
- Motor Drives

3. DEVICE MARKING AND ORDERING INFORMATION

Device	Marking	Shipping
S-LN01N100TZHG	EZ	1000/Tape&Reel

4. MAXIMUM RATINGS(Ta = 25°C)

Parameter	Symbol	Limits	Unit
Drain-Source Voltage	VDS	100	V
Gate-Source Voltage	VGS	±20	
Continuous Drain Current (Note1)	ID	3	A
Pulsed Drain Current (Note2)	IDM	12	
Avalanche Current	IAS	15.3	A
Avalanche Energy(L=0.1mH)	EAS	11.7	mJ
Power Dissipation (Note1)	PD	1.9	W
Operating Junction and Storage Temperature Range	TJ , Tstg	-55~+150	°C

5. THERMAL CHARACTERISTICS

Parameter	Symbol	Limits	Unit
Thermal Resistance,Junction-to-Ambient(Note 1)	RθJA	65	°C/W
Thermal Resistance,Junction-to-Case	RθJC	20	°C/W

- 1."1.5 x 1.5" FR4 board using 1 sq in pad, 2 oz Cu.
- 2.Pulse width limited by maximum junction temperature

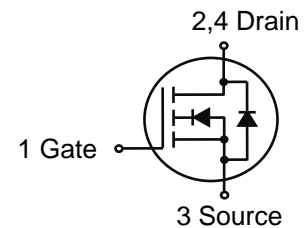
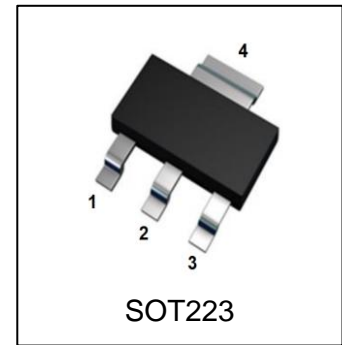

6. ELECTRICAL CHARACTERISTICS (Ta= 25°C)

Characteristic	Symbol	Min.	Typ.	Max.	Unit
Static					
Drain–Source Breakdown Voltage (VGS = 0V, ID = 250μA)	VBRDSS	100	-	-	V
Gate-Source Threshold Voltage (VDS =VGS , ID = 250μA)	VGS(th)	1.3	1.8	2.5	V
Gate-Body Leakage Current (VDS =0V, VGS =±20V)	IGSS	-	-	±100	nA
Zero Gate Voltage Drain Current (VDS = 80 V, VGS = 0 V)	IDSS	-	-	1	uA
Drain-Source On-Resistance(Note 3) (VGS = 10 V, ID = 2 A) (VGS = 6 V, ID = 2 A) (VGS = 4.5 V, ID = 2 A)	RDS(ON)	-	86 103 125	114 140 170	mΩ
Diode Forward Voltage (IS = 1 A, VGS = 0 V)	VSD	-	0.7	1.3	V
Dynamic					
Total Gate Charge	(VDD = 50 V, ID = 2 A, VGS = 10 V)	Qg	-	4.9	-
Gate-Source Charge		Qgs	-	1.9	-
Gate-Drain Charge		Qgd	-	1.2	-
Input Capacitance	(VGS = 0 V, VDS = 50 V, f= 1MHz)	Ciss	-	155	-
Output Capacitance		Coss	-	26.5	-
Reverse Transfer Capacitance		Crss	-	0.85	-
Turn-On Delay Time	(VDD = 50 V, ID = 2 A, VGS = 10 V, RG = 10 Ω, RL = 25 Ω)	td(on)	-	3.6	-
Rise Time		tr	-	4.1	-
Turn-Off Delay Time		td(off)	-	12.7	-
Fall Time		tf	-	4.4	-

3.Pulse test: PW ≤ 300us duty cycle ≤ 2%.

7. ELECTRICAL CHARACTERISTICS CURVES

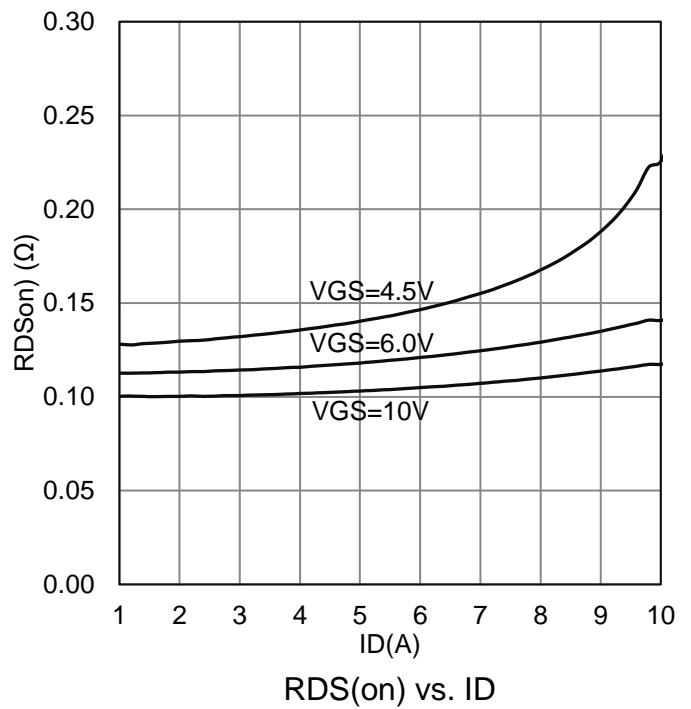
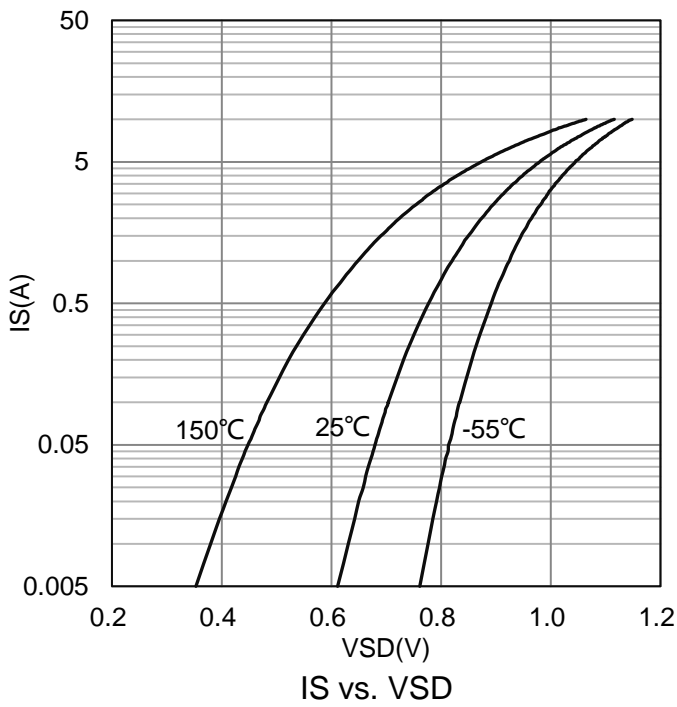
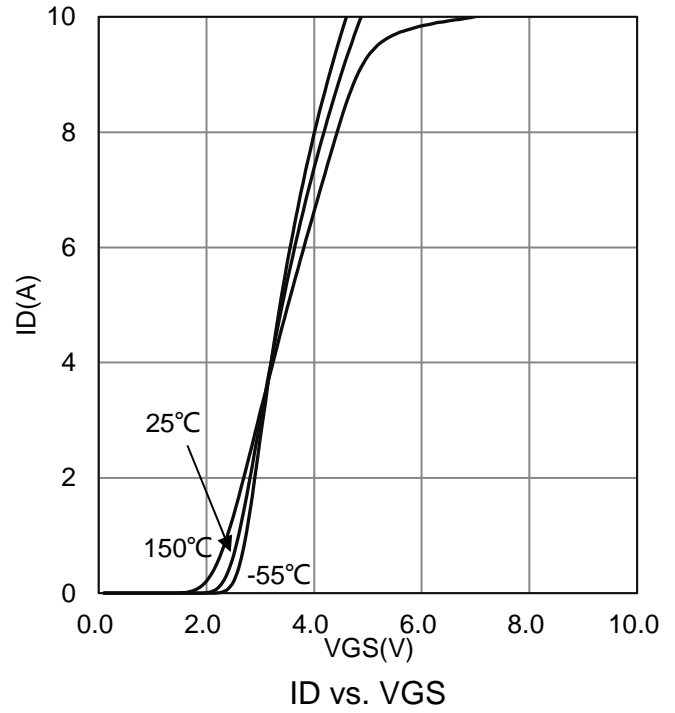
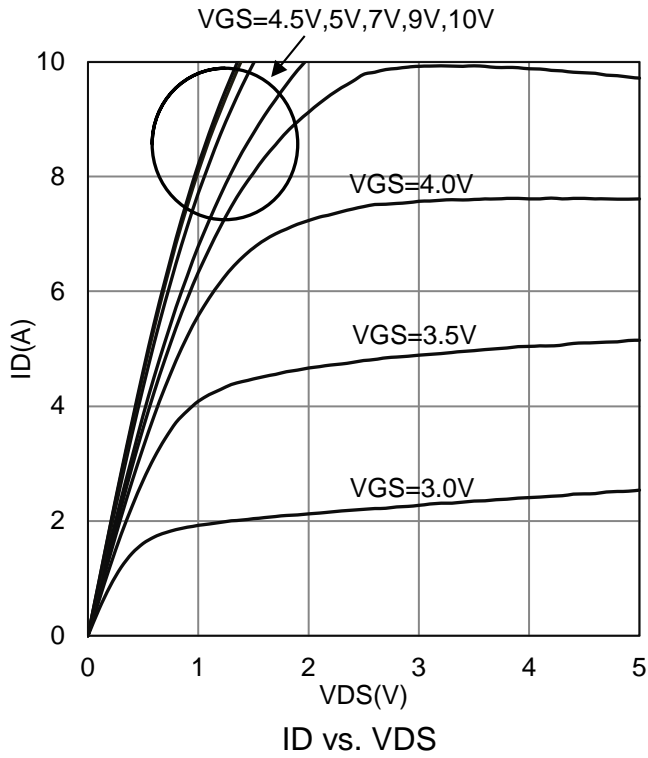

7. ELECTRICAL CHARACTERISTICS CURVES(Con.)

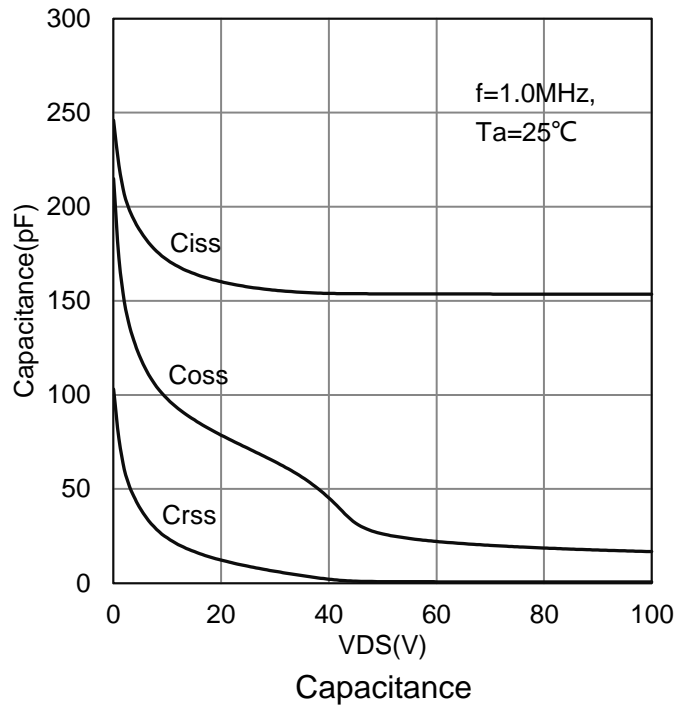
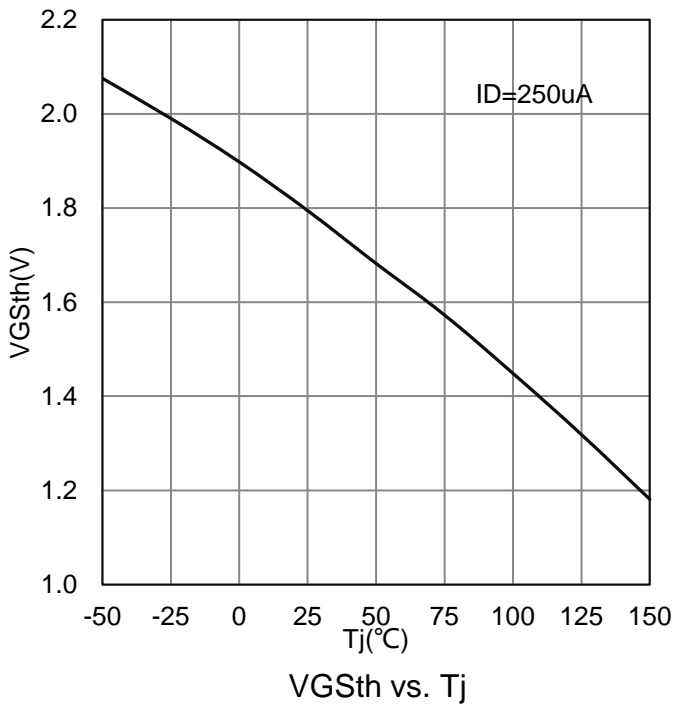
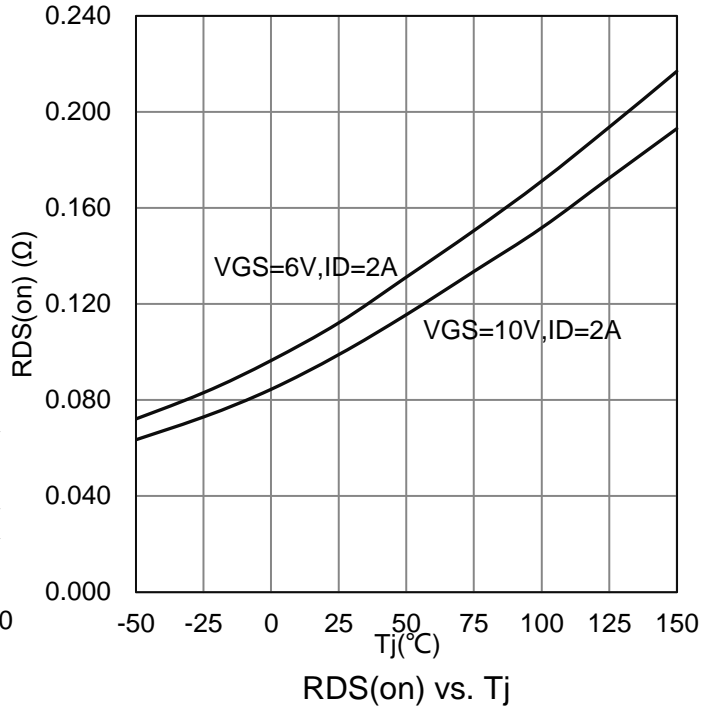
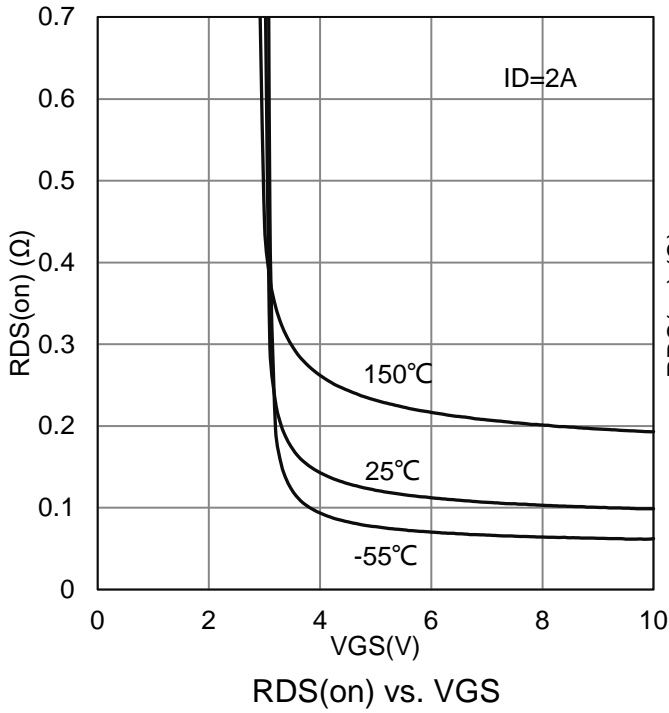

7. ELECTRICAL CHARACTERISTICS CURVES(Con.)

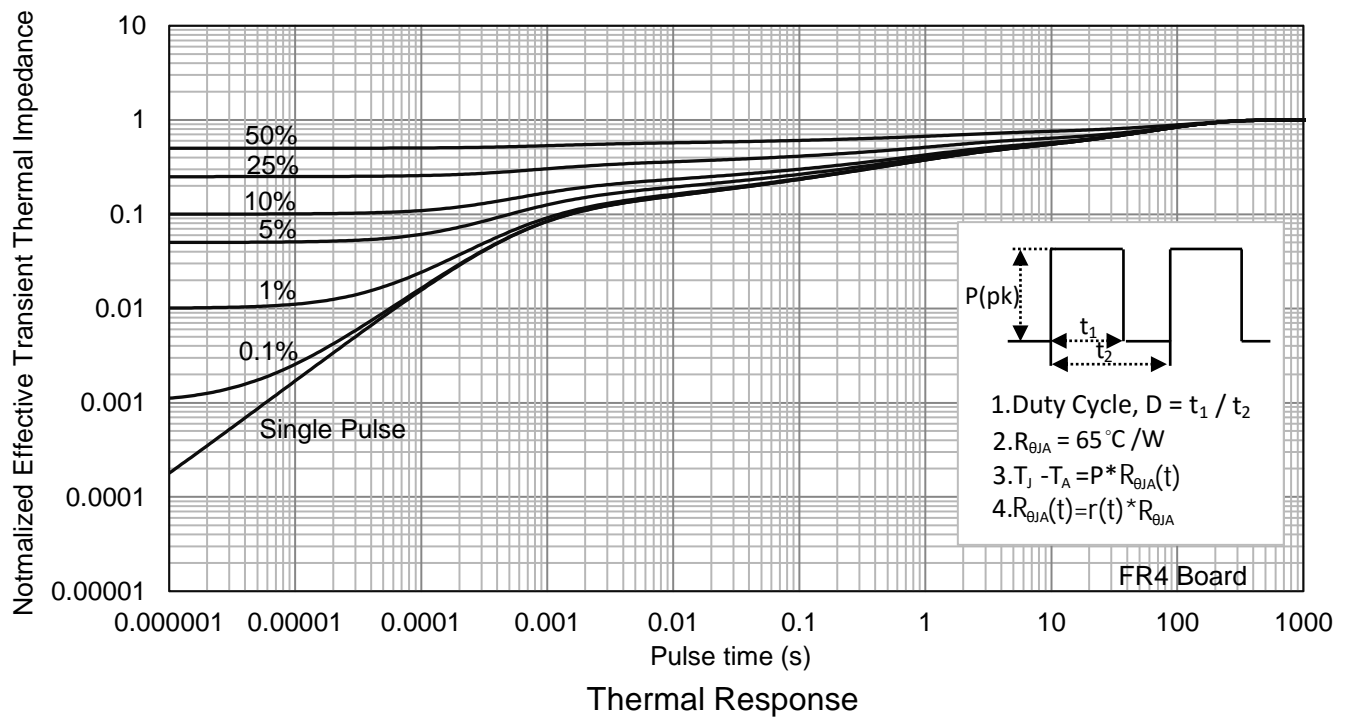
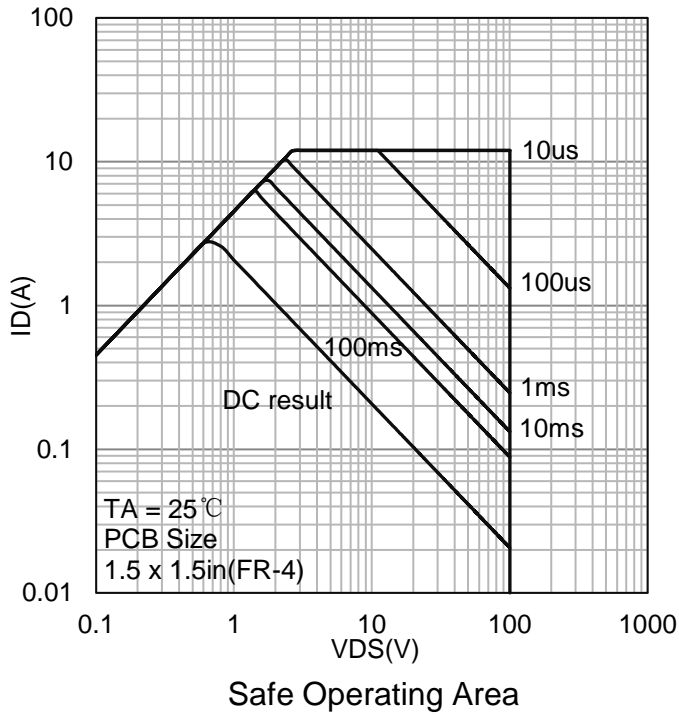

8. OUTLINE AND DIMENSIONS

SOT223

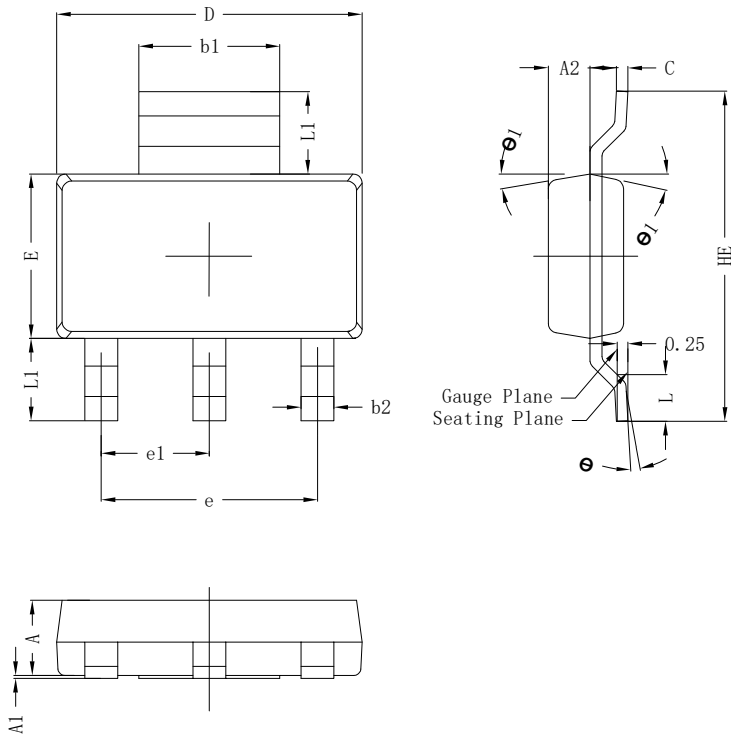

SOT223			
DIM	MIN	NOR	MAX
A	1.50	1.60	1.70
A1	0.00	0.05	0.10
A2	0.80	0.90	1.00
b1	2.90	3.02	3.10
b2	0.60	0.72	0.80
c	0.20	0.27	0.35
D	6.30	6.50	6.70
E	3.30	3.50	3.70
e	4.60BSC		
e1	2.30BSC		
HE	6.80	7.00	7.20
L	0.80	1.00	1.20
L1	1.75(REF)		
θ	0°~8°		
θ 1	8°	10°	12°
All Dimensions in mm			

GENERAL NOTES

1. Top package surface finish Ra0.4±0.2um
2. Bottom package surface finish Ra0.7±0.2um
3. Side package surface finish Ra0.4±0.2um
4. Protrusion or Gate Burrs shall not exceed 0.10mm per side.

9. SOLDERING FOOTPRINT

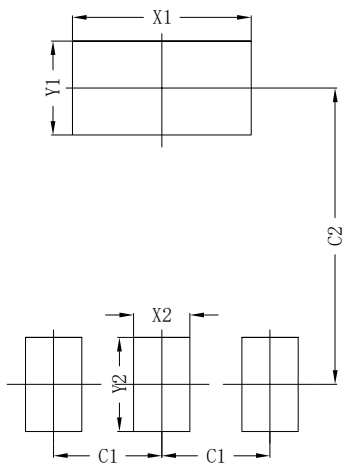

SOT223	
DIM	(mm)
X1	3.80
Y1	2.00
X2	1.20
Y2	2.00
C1	2.30
C2	6.30

DISCLAIMER

- Curve guarantee in the specification. The curve of test items with electric parameter is used as quality guarantee. The curve of test items without electric parameter is used as reference only.
- Before you use our Products for new Project, you are requested to carefully read this document and fully understand its contents. LRC shall not be in any way responsible or liable for failure, malfunction or accident arising from the use of any LRC's Products against warning, caution or note contained in this document.
- All information contained in this document is current as of the issuing date and subject to change without any prior notice. Before purchasing or using LRC's Products, please confirm the latest information with a LRC sales representative.

单击下面可查看定价，库存，交付和生命周期等信息

[>>LRC\(乐山无线电\)](#)