

LNTR4003NLT1G

S-LNTR4003NLT1G

30 V, 0.56 A, Single, N-Channel,
Gate ESD Protection, SOT-23

1. FEATURES

- Low gate voltage threshold(VGS(th))to facilitate drive circuit design
- Low gate charge for fast switching
- ESD protected gate
- Minimum breakdown voltage rating of 30 V
- We declare that the material of product compliance with RoHS requirements and Halogen Free.
- S- prefix for automotive and other applications requiring unique site and control change requirements; AEC-Q101 qualified and PPAP capable.

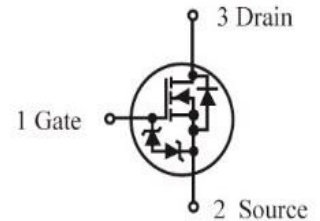
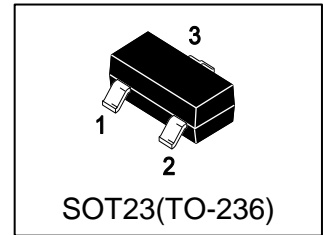

2. APPLICATIONS

- Level shifters
- Level switches
- Low side load switches
- Portable applications

3. DEVICE MARKING AND ORDERING INFORMATION

Device	Marking	Shipping
LNTR4003NLT1G	TR8	3000/Tape&Reel
LNTR4003NLT3G	TR8	10000/Tape&Reel

4. MAXIMUM RATINGS(Ta = 25°C)

Parameter	Symbol	Limits	Unit	
Drain-Source Voltage	VDSS	30	V	
Gate-to-Source Voltage – Continuous	VGS	±20	V	
Current (Note 1) Steady State	ID	TA = 25°C	0.5	A
		TA = 85°C	0.37	
Continuous Drain Current (Note 1) t<10s		TA = 25°C	0.56	
		TA = 85°C	0.4	
Pulsed Drain Current(tp=10µs)	IDM	1.7	A	
Continuous Source Current (Body Diode)	IS	1	A	
Maximum Power Dissipation(Note 1) Steady State	PD		0.69	W
		t<5s	0.83	
Junction and Storage temperature	TJ,Tstg	-55 ~ +150	°C	
Maximum Temperature for Soldering Purposes	TL	260	°C	

5. THERMAL CHARACTERISTICS

Parameter	Symbol	Limits	Unit
Thermal Resistance, Junction-to-Ambient Steady State(Note 1)	R θ JA	180	°C/W
t < 10s(Note 1)		150	

6. ELECTRICAL CHARACTERISTICS (Ta= 25°C)

OFF CHARACTERISTICS

Characteristic	Symbol	Min.	Typ.	Max.	Unit
Drain-Source Breakdown Voltage (VGS = 0, ID = 100 μ Adc)	V(BR)DSS	30	-	-	Vdc
Drain-to-Source Breakdown Voltage Temperature Coefficient	V(BR)DSS/ TJ	-	40	-	mV/°C
Zero Gate Voltage Drain Current (VDS=30V, VGS=0V)	IDSS	-	-	1.0	μ Adc
Gate-Body Leakage Current, Forward (VDS = 0 V, VGS = \pm 10 V)	IGSS	-	-	\pm 1.0	μ Adc

ON CHARACTERISTICS (Note 2)

Gate Threshold Voltage (VDS = VGS, ID = 250 μ Adc)	VGS(th)	0.8	-	1.6	Vdc
Negative Threshold Temperature Coefficient	VGS(TH)/TJ	-	3.4	-	mV/°C
Static Drain-Source On-State Resistance (VGS = 4.0 V, ID = 10 mA) (VGS = 2.5 V, ID = 10 mA)	RDS(on)	-	1 1.5	1.5 2	Ω
Forward Transconductance (VDS = 3.0 V, ID = 10 mA)	gfs	-	0.33	-	S

DYNAMIC CHARACTERISTICS

Input Capacitance (VGS = 0 V, f = 1.0MHz, VDS= 5 V)	Ciss	-	41	-	pF
Output Capacitance (VGS = 0 V, f = 1.0MHz, VDS= 5 V)	Coss	-	12	-	pF
Reverse Transfer Capacitance (VGS = 0 V, f = 1.0MHz, VDS= 5 V)	Crss	-	8.1	-	pF

SWITCHING CHARACTERISTICS

Turn-On Delay Time	(VGS = 4.5 V, VDD = 5.0 V, ID = 0.1 A, RG = 50 Ω)	td(on)	-	16.7	-	ns
Rise Time		tr	-	47.9	-	
Turn-Off Delay Time		td(off)	-	65.1	-	
Fall Time		tf	-	64.2	-	

SOURCE-DRAIN DIODE CHARACTERISTICS

Forward Voltage (VGS = 0 Vdc, ISD = 10 mAdc)	VSD	-	0.65	0.7	V
Reverse Recovery Time (VGS = 0 V, dIS/dt = 8A/ μ s, IS = 10 mA)	trr	-	14	-	ns

- Surface-mounted on FR4 board using 1 in sq pad size
(Cu area = 1.127 in sq [1 oz] including traces).
- Pulse Test: Pulse Width \leq 300 μ s, Duty Cycle \leq 2.0%.

7. ELECTRICAL CHARACTERISTICS CURVES

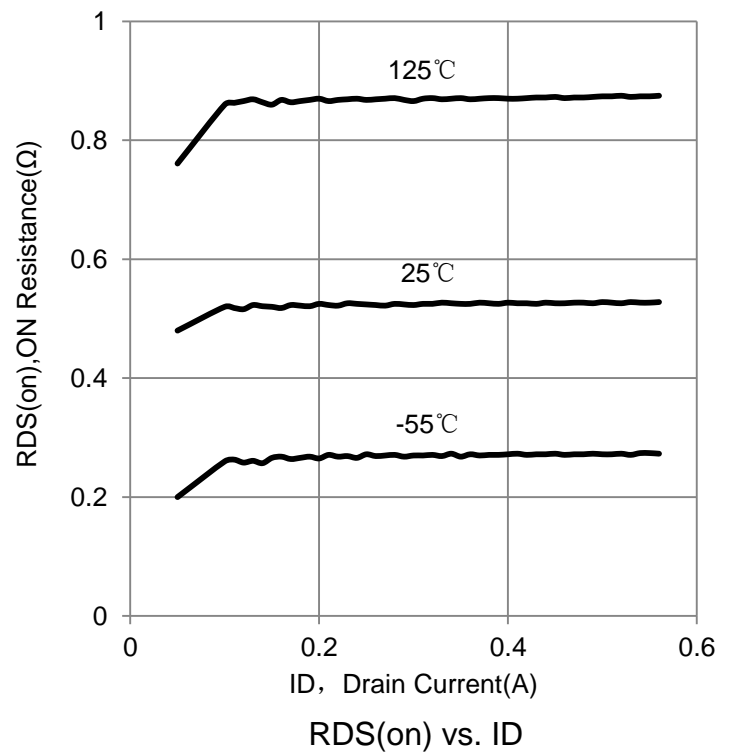
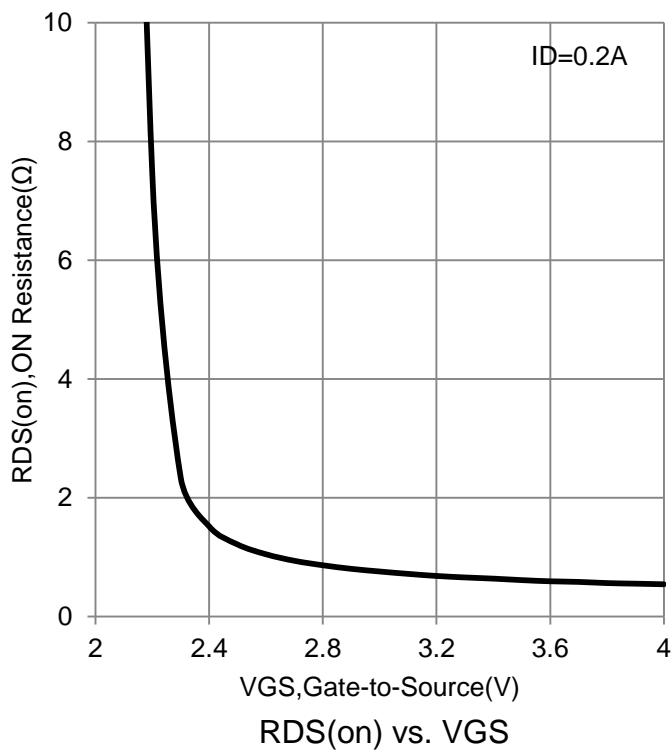
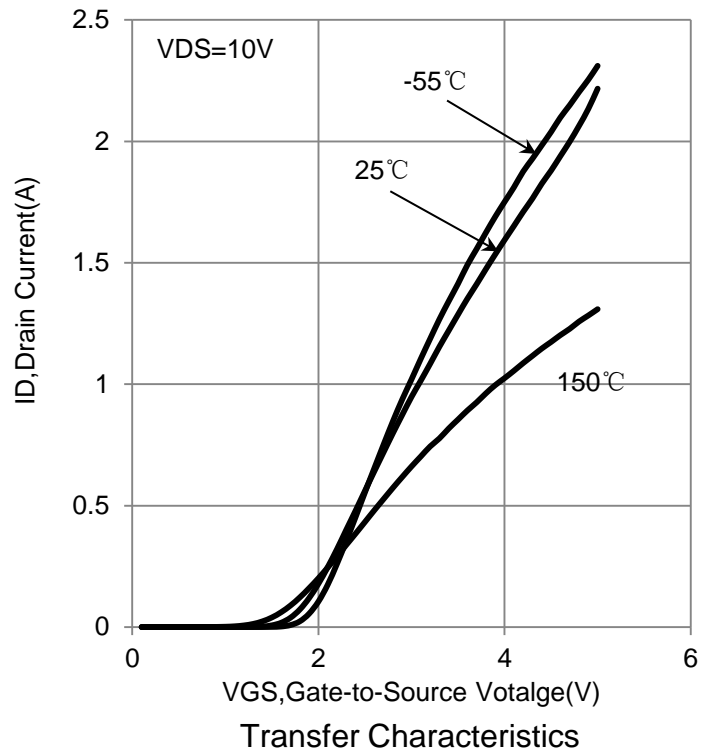
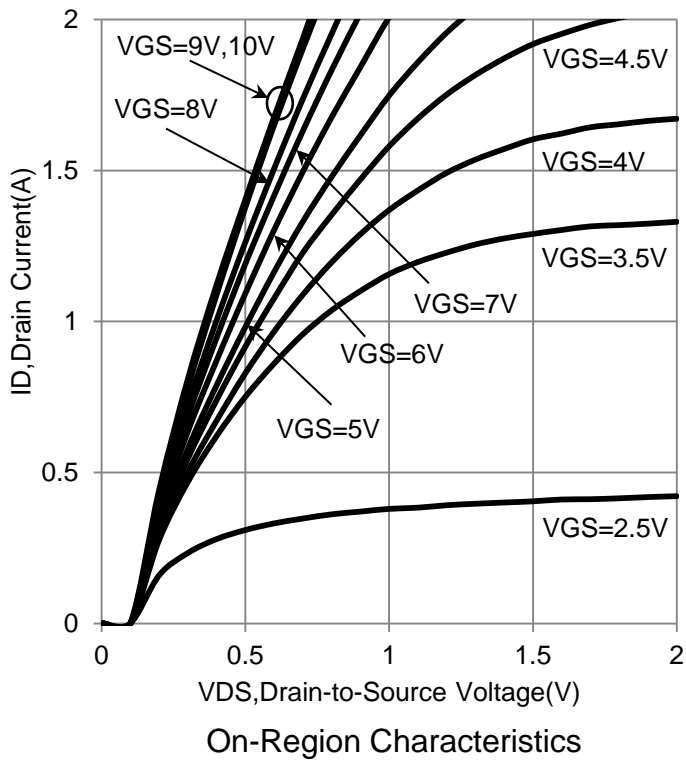

7. ELECTRICAL CHARACTERISTICS CURVES (Con.)

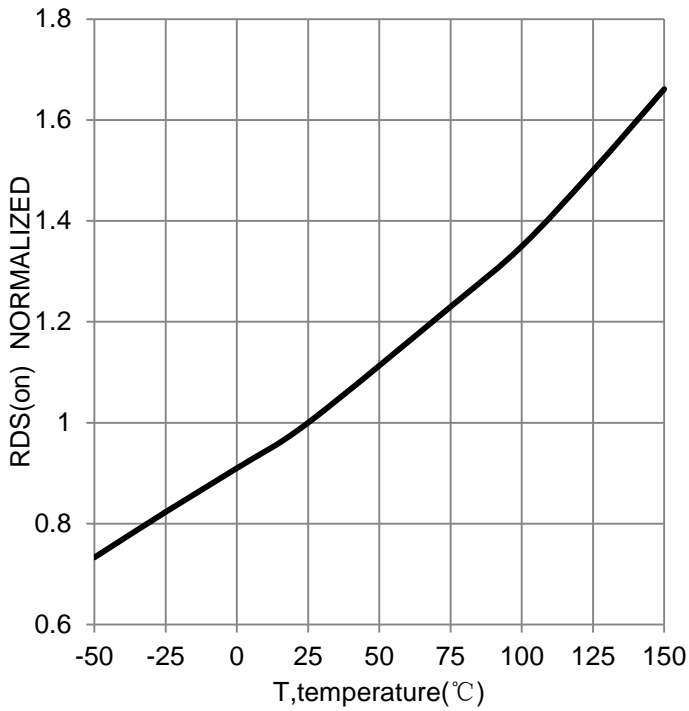

RDS(on) vs. Temperature

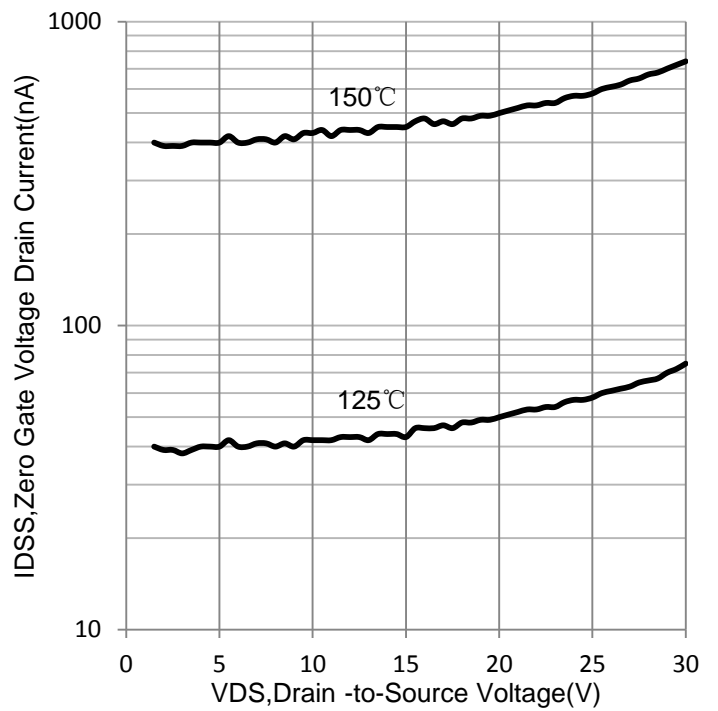

IDSS vs. VDS

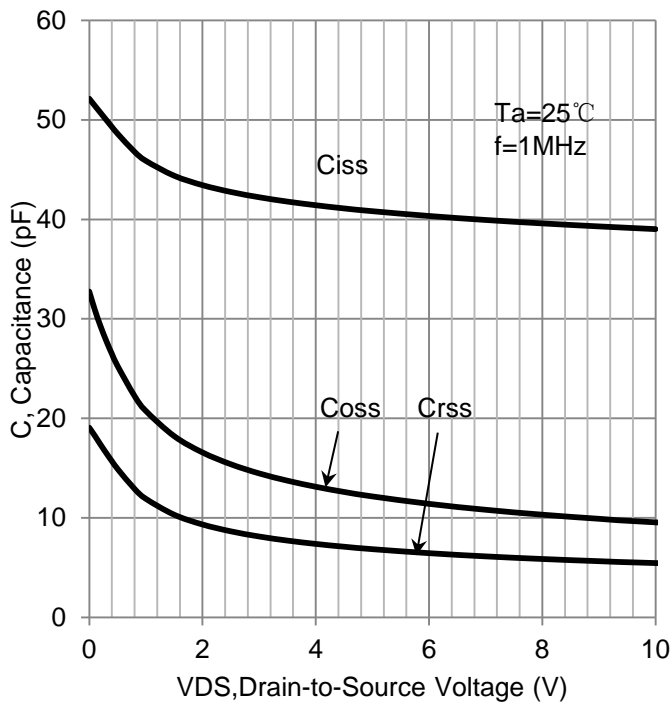

Capacitance Variation

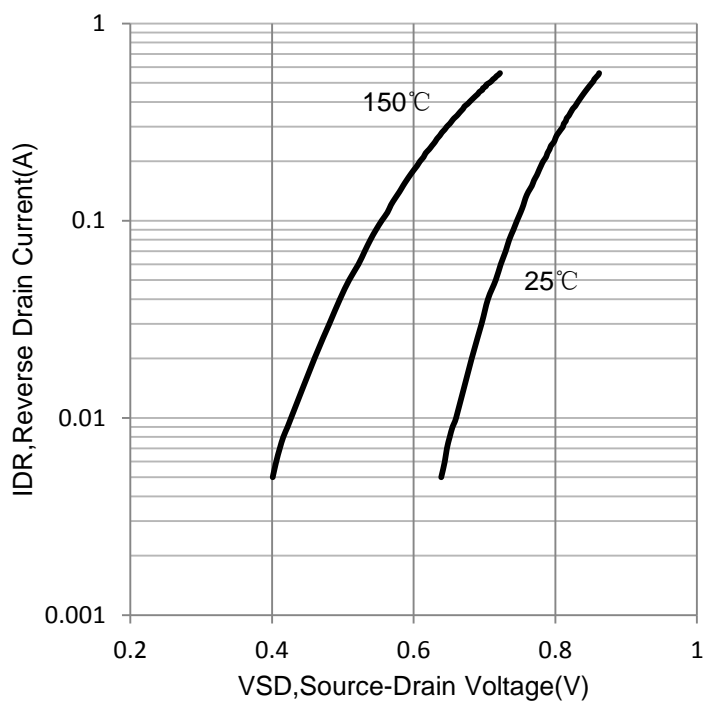

Diode Forward Characteristics

8. OUTLINE AND DIMENSIONS

Notes:

1. DIMENSIONING AND TOLERANCING PER ANSI Y14.5M, 1982.
2. CONTROLLING DIMENSION: MILLIMETERS.
3. MAXIMUM LEAD THICKNESS INCLUDES LEAD FINISH. MINIMUM LEAD THICKNESS IS THE MINIMUM THICKNESS OF BASE MATERIAL.
4. DIMENSIONS D AND E DO NOT INCLUDE MOLD FLASH, PROTRUSIONS OR GATE BURRS.

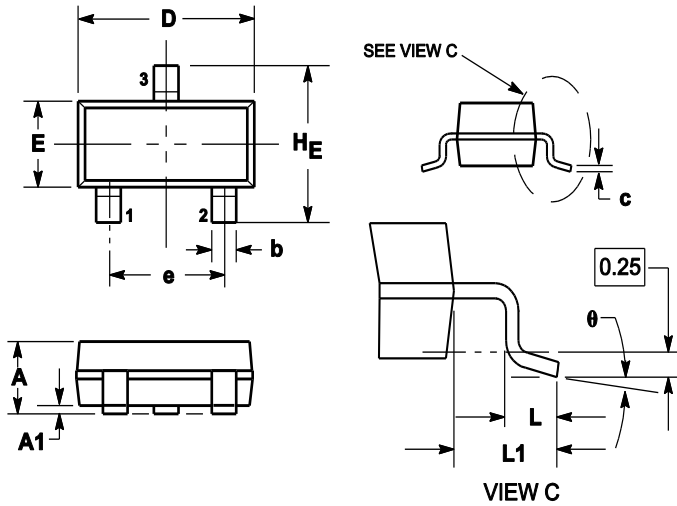

DIM	MILLIMETERS			INCHES		
	MIN	NOM	MAX	MIN	NOM	MAX
A	0.89	1	1.11	0.035	0.04	0.044
A1	0.01	0.06	0.1	0.001	0.002	0.004
b	0.37	0.44	0.5	0.015	0.018	0.02
c	0.09	0.13	0.18	0.003	0.005	0.007
D	2.80	2.9	3.04	0.11	0.114	0.12
E	1.20	1.3	1.4	0.047	0.051	0.055
e	1.78	1.9	2.04	0.07	0.075	0.081
L	0.10	0.2	0.3	0.004	0.008	0.012
L1	0.35	0.54	0.69	0.014	0.021	0.029
HE	2.10	2.4	2.64	0.083	0.094	0.104
θ	0°	---	10°	0°	---	10°

9. SOLDERING FOOTPRINT

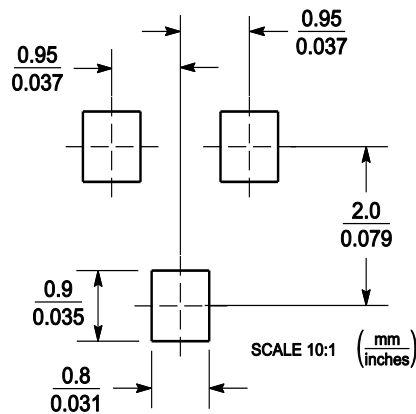

单击下面可查看定价，库存，交付和生命周期等信息

[>>LRC\(乐山无线电\)](#)