

Darlington Amplifier Transistors

- We declare that the material of product compliance with RoHS requirements.

ORDERING INFORMATION

Device	Marking	Shipping
LMBTA13LT1G S-LMBTA13LT1G	1M	3000/Tape & Reel
LMBTA14LT1G S-LMBTA14LT1G	1N	3000/Tape & Reel
LMBTA13LT3G S-LMBTA13LT3G	1M	10000/Tape & Reel
LMBTA14LT3G S-LMBTA14LT3G	1N	10000/Tape & Reel

LMBTA13LT1G
LMBTA14LT1G
S-LMBTA13LT1G
S-LMBTA14LT1G

MAXIMUM RATINGS

Rating	Symbol	Value	Unit
Collector–Emitter Voltage	V_{CES}	30	Vdc
Collector–Base Voltage	V_{CBO}	30	Vdc
Emitter–Base Voltage	V_{EBO}	10	Vdc
Collector Current — Continuous	I_C	300	mAdc

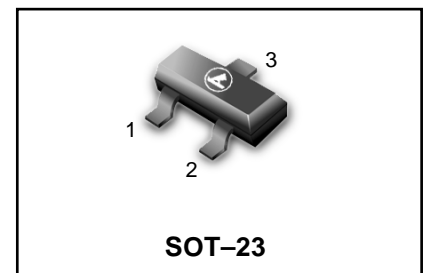

THERMAL CHARACTERISTICS

Characteristic	Symbol	Max	Unit
Total Device Dissipation FR–5 Board, (1) $T_A = 25^\circ\text{C}$	P_D	225	mW
Derate above 25°C		1.8	mW/ $^\circ\text{C}$
Thermal Resistance, Junction to Ambient	$R_{\theta JA}$	556	$^\circ\text{C}/\text{W}$
Total Device Dissipation Alumina Substrate, (2) $T_A = 25^\circ\text{C}$	P_D	300	mW
Derate above 25°C		2.4	mW/ $^\circ\text{C}$
Thermal Resistance, Junction to Ambient	$R_{\theta JA}$	417	$^\circ\text{C}/\text{W}$
Junction and Storage Temperature	T_J, T_{stg}	-55 to +150	$^\circ\text{C}$

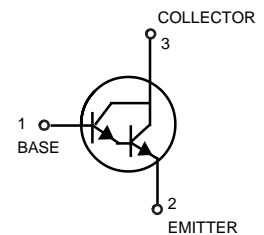

DEVICE MARKING

(S-)LMBTA13LT1G = 1M; (S-)LMBTA14LT1G = 1N;

ELECTRICAL CHARACTERISTICS ($T_A = 25^\circ\text{C}$ unless otherwise noted.)

Characteristic	Symbol	Min	Max	Unit
----------------	--------	-----	-----	------

OFF CHARACTERISTICS

Collector–Emitter Breakdown Voltage ($I_C = 100 \mu\text{Adc}, V_{BE} = 0$)	$V_{(BR)CEO}$	30	—	Vdc
Collector Cutoff Current ($V_{CB} = 30\text{Vdc}, I_E = 0$)	I_{CBO}	—	100	nAdc
Emitter Cutoff Current ($V_{EB} = 10\text{Vdc}, I_C = 0$)	I_{EBO}	—	100	nAdc

1. FR–5 = 1.0 x 0.75 x 0.062 in.

2. Alumina = 0.4 x 0.3 x 0.024 in. 99.5% alumina.

LMBTA13LT1G LMBTA14LT1G
S-LMBTA13LT1G S-LMBTA14LT1G

ELECTRICAL CHARACTERISTICS ($T_A = 25^\circ\text{C}$ unless otherwise noted) (Continued)

Characteristic	Symbol	Min	Max	Unit
ON CHARACTERISTICS (3)				
DC Current Gain ($I_C = 10 \text{ mAdc}, V_{CE} = 5.0 \text{ Vdc}$)	h_{FE}	5,000	—	—
	LMBTA13	5,000	—	—
	LMBTA14	10,000	—	—
($I_C = 100\text{mAdc}, V_{CE} = 5.0\text{Vdc}$)	LMBTA13	10,000	—	—
	LMBTA14	20,000	—	—
Collector–Emitter Saturation Voltage ($I_C = 100 \text{ mAdc}, I_B = 0.1 \text{ mAdc}$)	$V_{CE(sat)}$	—	1.5	Vdc
Base–Emitter On Voltage ($I_C = 100\text{mAdc}, V_{CE} = 5.0\text{Vdc}$)	V_{BE}	—	2.0	Vdc

SMALL–SIGNAL CHARACTERISTICS

Current – Gain–Bandwidth Product(4) ($V_{CE} = 5.0 \text{ Vdc}, I_C = 10\text{mAdc}, f = 100 \text{ MHz}$)	f_T	125	—	MHz
---	-------	-----	---	-----

3. Pulse Test: Pulse Width $\leq 300 \mu\text{s}$, Duty Cycle $\leq 2.0\%$.

4. $f_T = |h_{fe}| * f_{test}$.

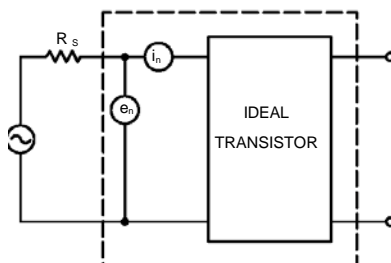

Figure 1. Transistor Noise Model

LMBTA13LT1G LMBTA14LT1G
S-LMBTA13LT1G S-LMBTA14LT1G

NOISE CHARACTERISTICS

($V_{CE} = 5.0 \text{ Vdc}$, $T_A = 25^\circ\text{C}$)

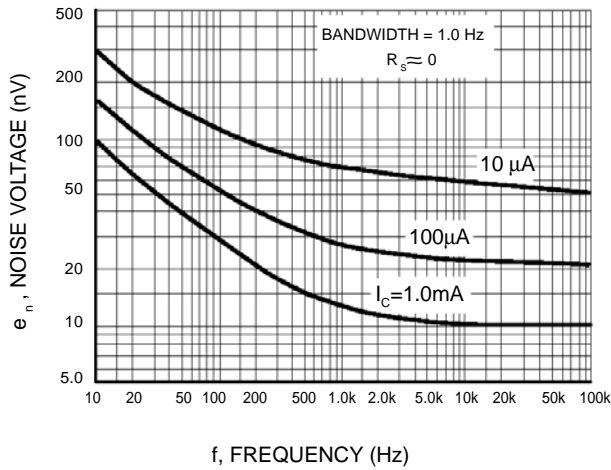

Figure 2. Noise Voltage

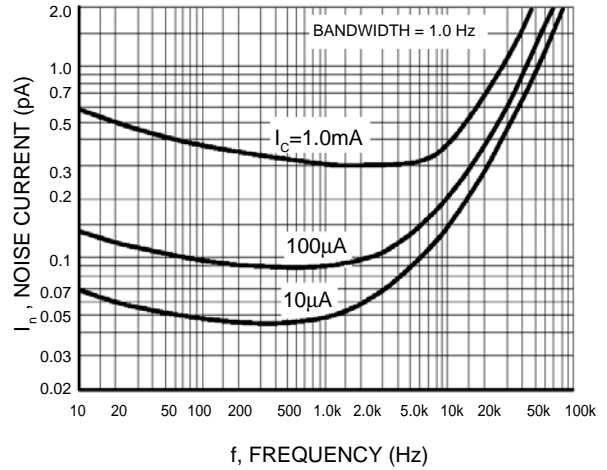

Figure 3. Noise Current

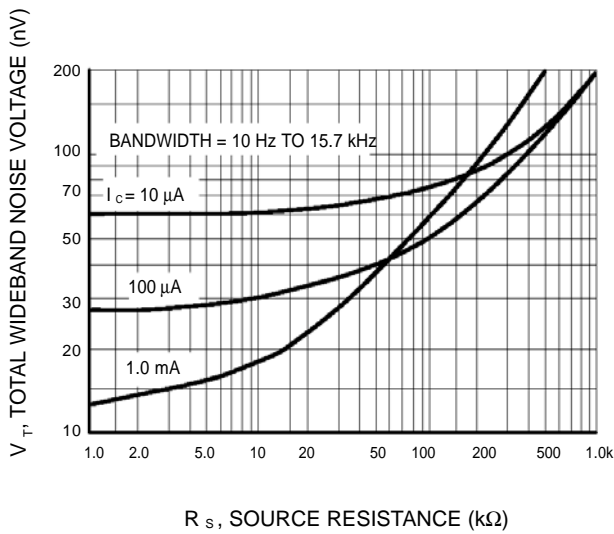

Figure 4. Total Wideband Noise Voltage

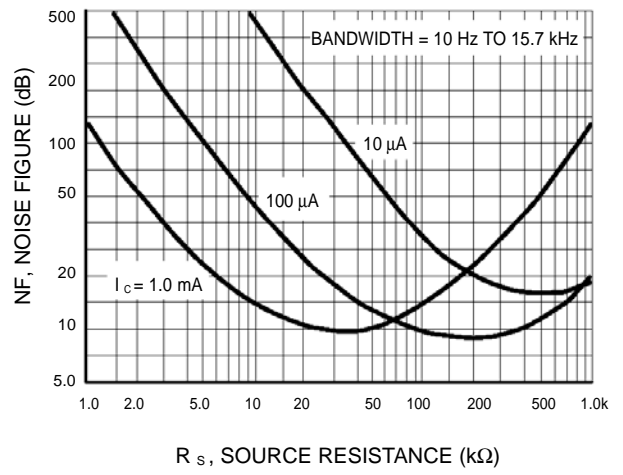

Figure 5. Wideband Noise Figure

LMBTA13LT1G LMBTA14LT1G
S-LMBTA13LT1G S-LMBTA14LT1G

SMALL-SIGNAL CHARACTERISTICS

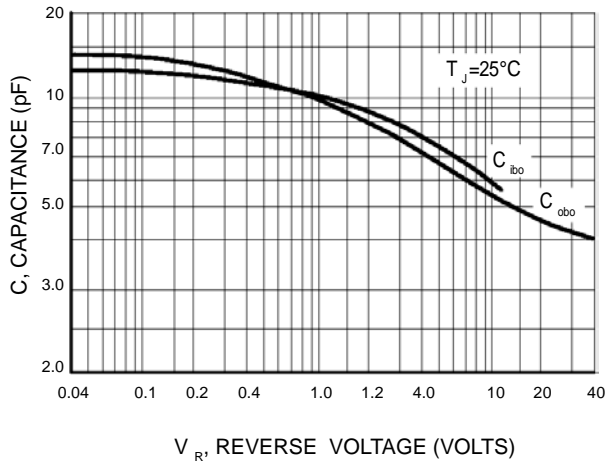

Figure 6. Capacitance

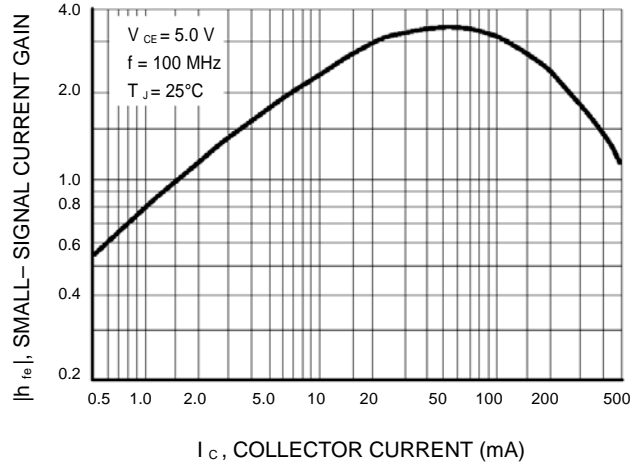

Figure 7. High Frequency Current Gain

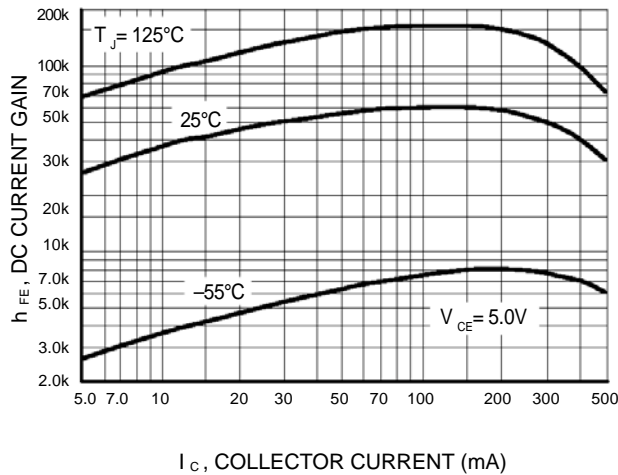

Figure 8. DC Current Gain

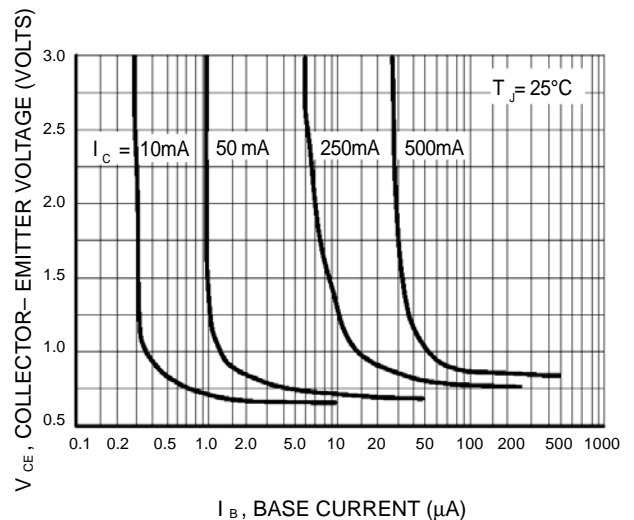

Figure 9. Collector Saturation Region

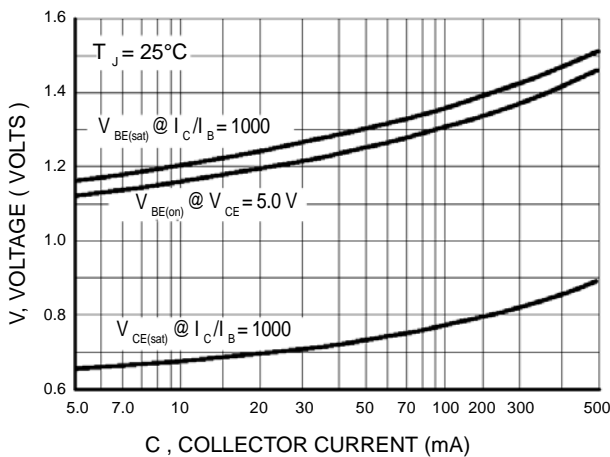

Figure 17. "ON" Voltages

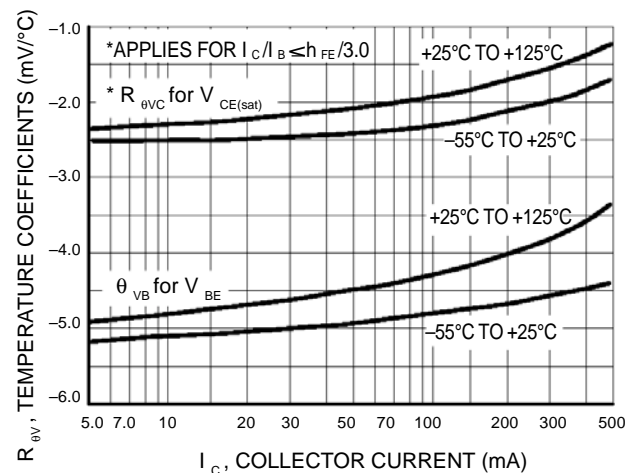

Figure 18. Temperature Coefficients

LMBTA13LT1G LMBTA14LT1G
S-LMBTA13LT1G S-LMBTA14LT1G

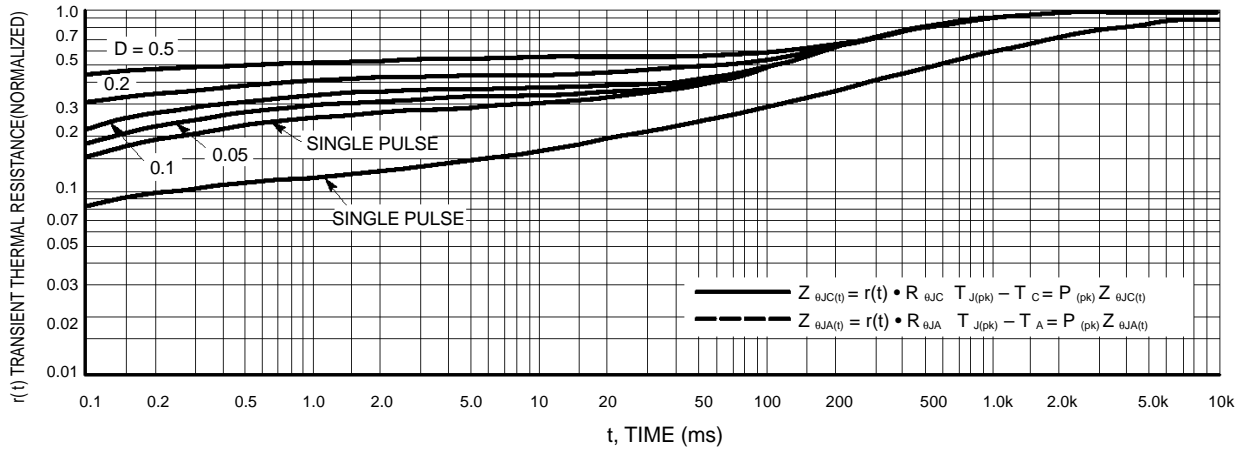

Figure 12. Thermal Response

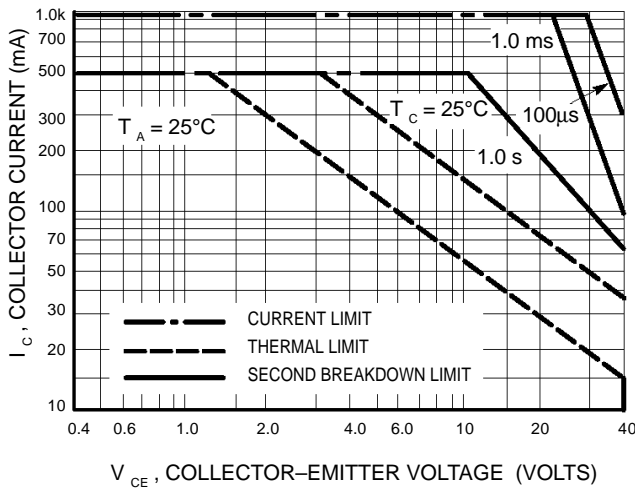
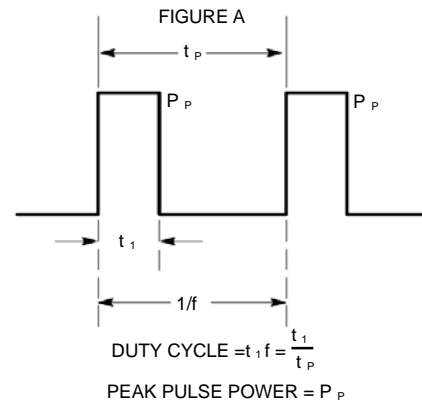

Figure 13. Active Region Safe Operating Area



Design Note: Use of Transient Thermal Resistance Data

LMBTA13LT1G LMBTA14LT1G
S-LMBTA13LT1G S-LMBTA14LT1G

SOT-23

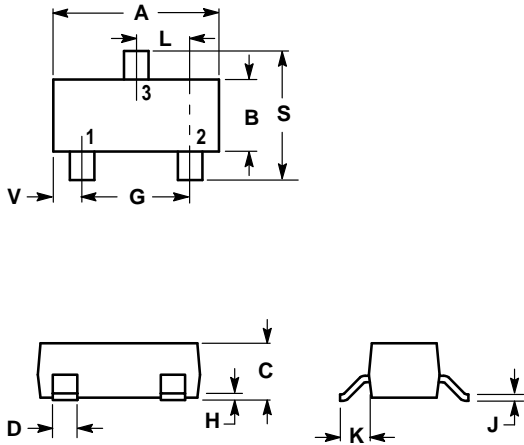

NOTES:

1. DIMENSIONING AND TOLERANCING PER ANSI Y14.5M, 1982.
2. CONTROLLING DIMENSION: INCH.

DIM	INCHES		MILLIMETERS	
	MIN	MAX	MIN	MAX
A	0.1102	0.1197	2.80	3.04
B	0.0472	0.0551	1.20	1.40
C	0.0350	0.0440	0.89	1.11
D	0.0150	0.0200	0.37	0.50
G	0.0701	0.0807	1.78	2.04
H	0.0005	0.0040	0.013	0.100
J	0.0034	0.0070	0.085	0.177
K	0.0140	0.0285	0.35	0.69
L	0.0350	0.0401	0.89	1.02
S	0.0830	0.1039	2.10	2.64
V	0.0177	0.0236	0.45	0.60

- PIN 1. BASE
 2. EMITTER
 3. COLLECTOR

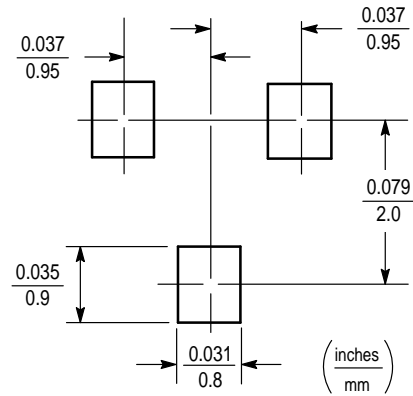

单击下面可查看定价，库存，交付和生命周期等信息

[>>LRC\(乐山无线电\)](#)