

## 1A Bipolar Linear Regulator

# S-LR1117D

### DESCRIPTION

S-LR1117D is a series of low dropout three-terminal regulators with a dropout of 1.3V at 1A load current. S-LR1117D features a very low standby current 2mA compared to 5mA of competitor.

Other than a fixed version,  $V_{out} = 1.2V, 1.5V, 1.8V, 2.5V, 2.85V, 3.3V, 5V$ , S-LR1117D has an adjustable version, which can provide an output voltage from 1.25V to 12V with only two external resistors.

S-LR1117D offers thermal shut down functions, to assure the stability of chip and power system. And it uses trimming technique to guarantee output voltage accuracy within  $\pm 2\%$ . Other output voltage accuracy can be customized on demand, such as  $\pm 1\%$

S-LR1117D is available in SOT-223, TO-252 power package.

### TYPICAL APPLICATION

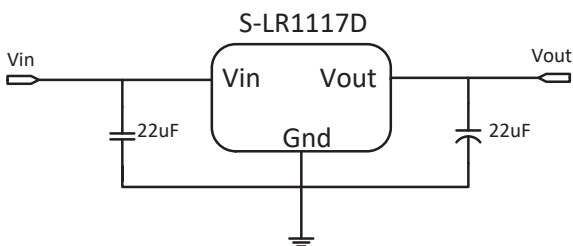

Application circuit of S-LR1117D fixed version

**NOTE:** Input capacitor ( $C_{in}=22\mu F$ ) and Output capacitor ( $C_{out}=22\mu F$ ) are recommended in all application circuit. Tantalum capacitor is recommended.

### FEATURES

- Other than a fixed version and an adjustable version, output value can be customized on demand.
- Output current : 1.0A
- Range of operation input voltage: Max 15V
- Standby current: 4mA (typ.)
- Line regulation: 0.03%/V (typ.)
- Load regulation: 0.2%/A (typ.)
- Environment Temperature:  $-40^{\circ}C \sim 125^{\circ}C$
- S- prefix for automotive and other applications requiring unique site and control change requirements; AEC-Q100 qualified and PPAP capable.

### APPLICATIONS

- Power Management for Computer Mother Board, Graphic Card
- BLD Monitor and BLD TV
- DVD Decode Board
- ADSL Modem
- Post Regulators for Switching Supplies

### TYPICAL ELECTRICAL CHARACTERISTIC

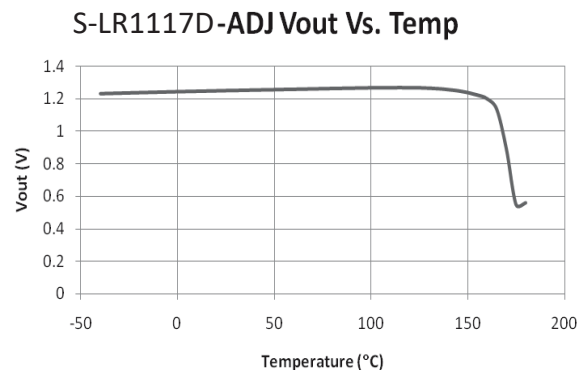

### ORDERING INFORMATION

### PIN CONFIGURATION AND MARKING

**S-LR1117DX XX X**

Rohs Std.  
 X: Pb-free Rohs Std, Output voltage accuracy within ±2%  
 Output Voltage:  
 12.....1.2V  
 15.....1.5V  
 18.....1.8V  
 25.....2.5V  
 28.....2.85V  
 33.....3.3V  
 50.....5.0V  
 .....ADJ

Package Type:  
 S: SOT-223  
 D: TO-252  
 S-: Automotive Grade

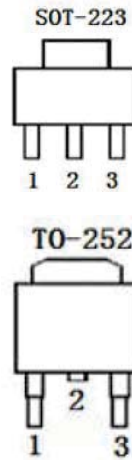

**Pin Description:**  
 Fixed Version

Pin No.	Symbol	Definition
1	Gnd	Ground
2	Vout	Output
3	Vin	Input

Adjustable Version

Pin No.	Symbol	Definition
1	Adj.	Adjustable
2	Vout	Output
3	Vin	Input

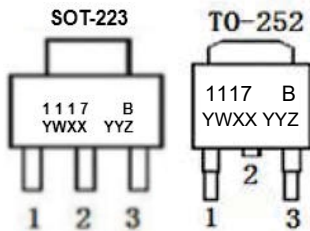

Marking	Designator	Description
1 1 1 7 B YWXX YYZ	1117 B	Product code
	YW	assemble year and week
	XX	Manufacture Lot No. (the end two number)
	YY	Output Voltage
	Z	Version please fixed

### ABSOLUTE MAXIMUM RATING

Parameter	Value
Max Input Voltage	18V <sup>①</sup>
Max Operating Junction Temperature(Tj)	150°C
Ambient Operating Temperature(Ta)	-40°C - 125°C
Storage Temperature(Ts)	-40°C - 150°C
Lead Temperature & Time	260°C, 10s

Note: Exceed these limits to damage to the device. Exposure to absolute maximum rating conditions may affect device reliability.

### RECOMMENDED WORK CONDITIONS

Parameter	Value	
Input Operation Voltage Range	Max. 15V	
Operating Junction Temperature(Tj)	-40°C -125°C	
Environment Temperature	-40°C -125°C	
Thermal Resistance - Juncion to Case	SOT223	25°C/W
	TO252	10°C/W
Thermal Resistance - Juncion to Ambient	SOT223	136°C/W
	TO252	105°C/W

Note: 1.Rθja Test conditions:The device mounted on 42.25mm2(Pin2) FR-4 board with 2oz. Copper

$$2. P_D = \frac{T_J(max) - T_A}{R_{\theta JA}}$$

**ELECTRICAL CHARACTERISTICS**

Tj=25°C

Symbol	Parameter	Conditions	Min	Typ	Max	Unit
Vref	Reference Voltage	S-LR1117D-ADJ 10mA ≤ Iout ≤ 1A, Vin = 3.25V	1.225	1.25	1.275	V
Vout	Output Voltage	S-LR1117D-1.2V 0 ≤ Iout ≤ 1A, Vin = 3.2V	1.164	1.2	1.224	V
		S-LR1117D-1.5V 0 ≤ Iout ≤ 1A, Vin = 3.5V	1.47	1.5	1.53	V
		S-LR1117D-1.8V 0 ≤ Iout ≤ 1A, Vin = 3.8V	1.764	1.8	1.836	V
		S-LR1117D-2.5V 0 ≤ Iout ≤ 1A, Vin = 4.5V	2.45	2.5	2.55	V
		S-LR1117D-2.85V 0 ≤ Iout ≤ 1A, Vin = 4.85V	2.793	2.85	2.907	V
		S-LR1117D-3.3V 0 ≤ Iout ≤ 1A, Vin = 5.3V	3.234	3.3	3.366	V
		S-LR1117D-5.0V 0 ≤ Iout ≤ 1A, Vin = 7.0V	4.9	5	5.1	V
		ΔVout	Line Regulation	S-LR1117D-ADJ Iout = 10mA, 2.75V ≤ Vin ≤ 12V		0.03
S-LR1117D-1.2V Iout = 10mA, 2.7V ≤ Vin ≤ 10V				0.03	0.2	%/V
S-LR1117D-1.5V Iout = 10mA, 3.0V ≤ Vin ≤ 12V				0.03	0.2	%/V
S-LR1117D-1.8V Iout = 10mA, 3.0V ≤ Vin ≤ 12V				0.03	0.2	%/V
S-LR1117D-2.5V Iout = 10mA, 3.3V ≤ Vin ≤ 12V				0.03	0.2	%/V
S-LR1117D-2.85V Iout = 10mA, 4.0V ≤ Vin ≤ 12V				0.03	0.2	%/V
S-LR1117D-3.3V Iout = 10mA, 4.8V ≤ Vin ≤ 12V				0.03	0.2	%/V
S-LR1117D-5.0V Iout = 10mA, 6.5V ≤ Vin ≤ 12V				0.03	0.2	%/V
ΔVout	Load Regulation	S-LR1117D-ADJ Vin = 2.75V, 10mA ≤ Iout ≤ 1A		2	8	mV
		S-LR1117D-1.2V Vin = 2.7V, 10mA ≤ Iout ≤ 1A		2	8	mV
		S-LR1117D-1.5V Vin = 3.0V, 10mA ≤ Iout ≤ 1A		2	10	mV
		S-LR1117D-1.8V Vin = 3.3V, 10mA ≤ Iout ≤ 1A		3	12	mV
		S-LR1117D-2.5V Vin = 3.8V, 10mA ≤ Iout ≤ 1A		4	16	mV
		S-LR1117D-2.85V Vin = 4.35V, 10mA ≤ Iout ≤ 1A		5	20	mV
		S-LR1117D-3.3V Vin = 4.8V, 10mA ≤ Iout ≤ 1A		6	24	mV
		S-LR1117D-5.0V Vin = 6.5V, 10mA ≤ Iout ≤ 1A		9	36	mV

**ELECTRICAL CHARACTERISTICS continued**

T<sub>j</sub>=25°C

Symbol	Parameter	Conditions	Min	Typ	Max	Unit
Vdrop	Dropout Voltage	I <sub>out</sub> =100mA		1.15	1.4	V
		I <sub>out</sub> =1A		1.2	1.4	V
I <sub>limit</sub>	Current Limit	V <sub>in</sub> -V <sub>out</sub> =1.5V, T <sub>j</sub> =25°C	1	1.5		A
SVR	Supply Voltage Rejection	f = 120Hz, V <sub>IN</sub> - V <sub>OUT</sub> = 3V + 1VPP Ripple	60			dB
I <sub>min</sub>	Minimum Load Current	S-LR1117D-ADJ		2	10	mA
I <sub>q</sub>	Quiescent Current	S-LR1117D-1.2V, V <sub>in</sub> =10V	1	4	6	mA
		S-LR1117D-1.5V, V <sub>in</sub> =11V	1	4	6	mA
		S-LR1117D-1.8V, V <sub>in</sub> =11V	1	4	6	mA
		S-LR1117D-1.5V, V <sub>in</sub> =11V	1	4	6	mA
		S-LR1117D-2.5V, V <sub>in</sub> =12V	1	4	6	mA
		S-LR1117D-2.85V, V <sub>in</sub> =12V	1	4	6	mA
		S-LR1117D-3.3V, V <sub>in</sub> =12V	1	4	6	mA
		S-LR1117D-5.0V, V <sub>in</sub> =12V	1	4	6	mA
I <sub>Adj</sub>	Adjust Pin Current	1.5V ≤ V <sub>IN</sub> - V <sub>OUT</sub> ≤ 10V I <sub>LOAD</sub> =10 mA		35	60	uA
ΔV/ΔT	Temperature coefficient			±100		ppm

Note1: All test are conducted under ambient temperature 25°C and within a short period of time 20ms

Note2: Load current smaller than minimum load current of S-LR1117D-ADJ will lead to unstable or oscillation output.

**BLOCK DIAGRAM**

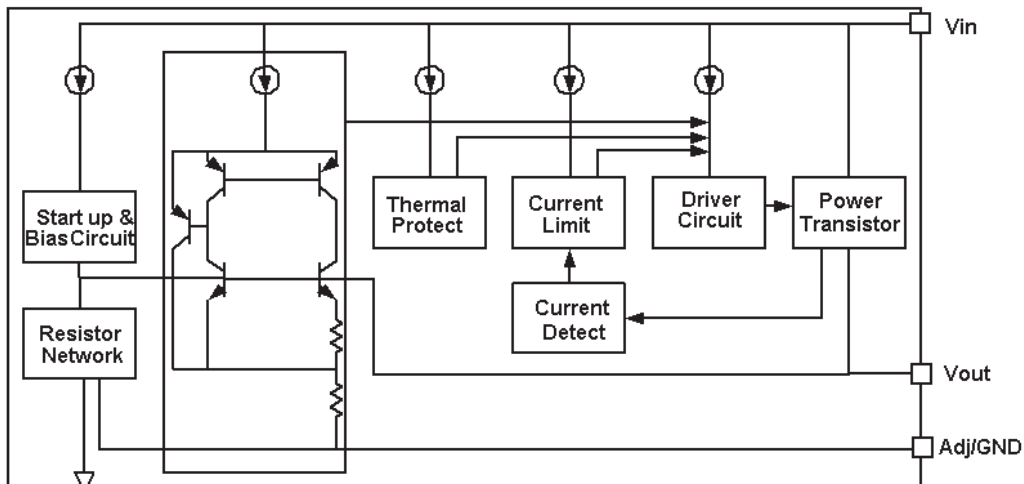

## DETAILED DESCRIPTION

S-LR1117D is a series of low dropout voltage, three terminal regulators. Its application circuit is very simple: the fixed version only needs two capacitors and the adjustable version only needs two resistors and two capacitors to work. It is composed of some modules including start-up circuit, bias circuit, bandgap, thermal shutdown, power transistors and its driver circuit and so on.

The thermal shut down modules can assure chip and its application system working safety when the junction temperature is larger than 140°C.

The bandgap module provides stable reference voltage, whose temperature coefficient is compensated by careful design considerations. The temperature coefficient is under 100 ppm/°C. And the accuracy of output voltage is guaranteed by trimming technique.

## TYPICAL APPLICATION

S-LR1117D has an adjustable version and six fixed versions (1.2V, 1.5V, 1.8V, 2.5V, 2.85V, 3.3V, 5V )

### Fixed Output Voltage Version

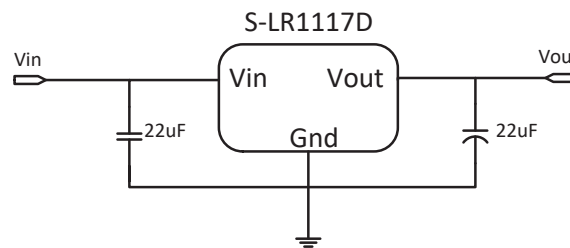

Application circuit of S-LR1117D fixed version

- 1) Recommend using 22µF tan capacitor or MLCC capacitor as bypass capacitor (C1) for all application circuit.
- 2) Recommend using 22µF tan capacitor or MLCC capacitor to assure circuit stability.
- 3) Capacitor ESR range: 3mΩ ~ 22Ω

### Adjustable Output Voltage Version

S-LR1117D-ADJ provides a 1.25V reference voltage. Any output voltage between 1.25V~12V can be achievable by choosing two external resistors (schematic is shown below), R1 and R2

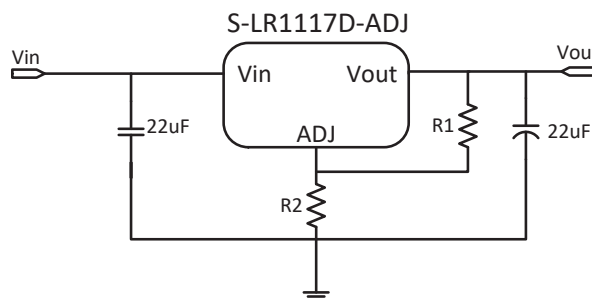

Application Circuit of S-LR1117D-ADJ

The output voltage of adjustable version follows the equation:  $V_{out} = 1.25 \times (1 + R2/R1) + I_{Adj} \times R2$ . We can ignore  $I_{Adj}$  because  $I_{Adj}$  (about 50µA) is much less than the current of R1 (about 2~10mA).

- 1) To meet the minimum load current (>10mA) requirement, R1 is recommended to be 125ohm or lower. As S-LR1117D-ADJ can keep itself stable at load current about 2mA, R1 is not allowed to be higher than 625ohm.
- 2) Using a bypass capacitor ( $C_{ADJ}$ ) between the ADJ pin and ground can improve ripple rejection. This bypass capacitor prevents ripple from being amplified as the output voltage is increased. The impedance of  $C_{ADJ}$  should be less than R1 to prevent ripple from being amplified. As R1 is normally in the range of  $100\Omega \sim 500\Omega$ , the value of  $C_{ADJ}$  should satisfy this equation:  $1/(2\pi \times f_{ripple} \times C_{ADJ}) < R1$ .

## THERMAL CONSIDERATIONS

We have to take heat dissipation into great consideration when output current or differential voltage of input and output voltage is large. Because in such cases, the power dissipation consumed by S-LR1117D is very large. S-LR1117D series uses SOT-223 package type and its thermal resistance is about 20°C/W. And the copper area of application board can affect the total thermal resistance. If copper area is 5cm\*5cm (two sides), the resistance is about 30°C/W. So the total thermal resistance is about 20°C/W + 30°C/W. We can decrease total thermal resistance by increasing copper area in application board. When there is no good heat dissipation copper are in PCB, the total thermal resistance will be as high as 120°C/W, then the power dissipation of S-LR1117D could allow on itself is less than 1W. And furthermore, S-LR1117D will work at junction temperature higher than 125°C under such condition and no lifetime is guaranteed

## TYPICAL PERFORMANCE CHARACTERISTICS

$T=25^{\circ}\text{C}$  unless specified.

### Line Regulation

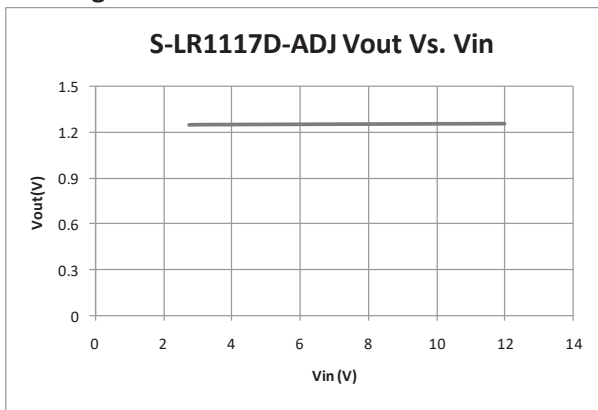

### Load Regulation

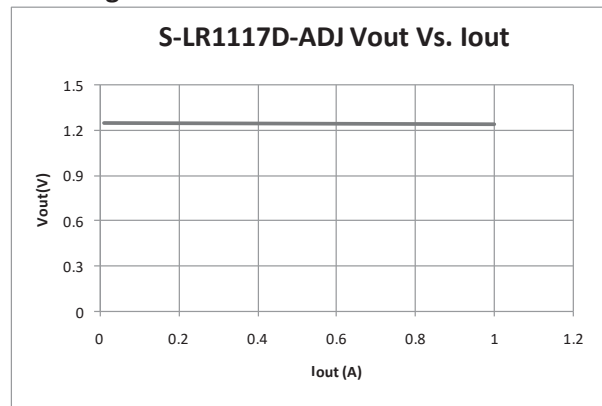

### Dropout Voltage

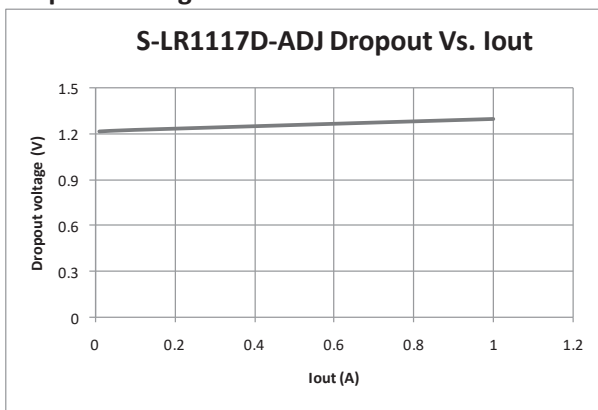

### Thermal performance with OTP

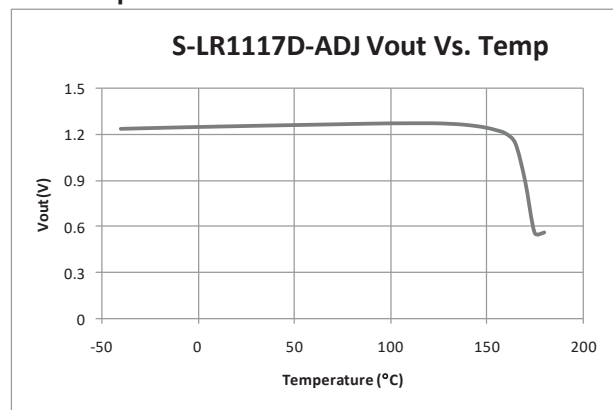

Dropout Voltage vs. Output Current

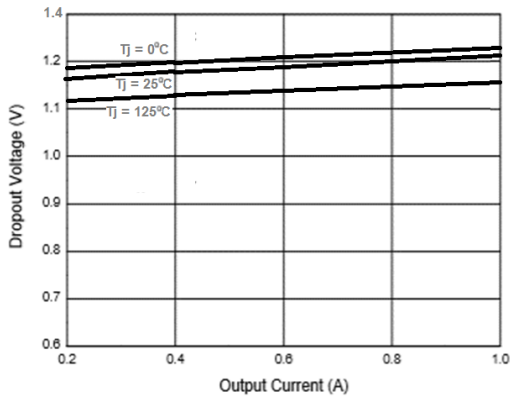

Dropout Voltage vs. Junction Temperature

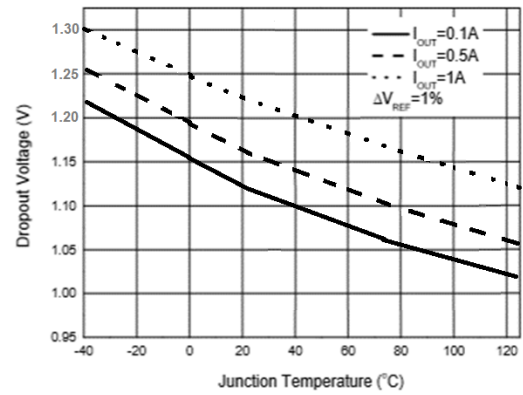

Load Regulation vs. Junction Temperature

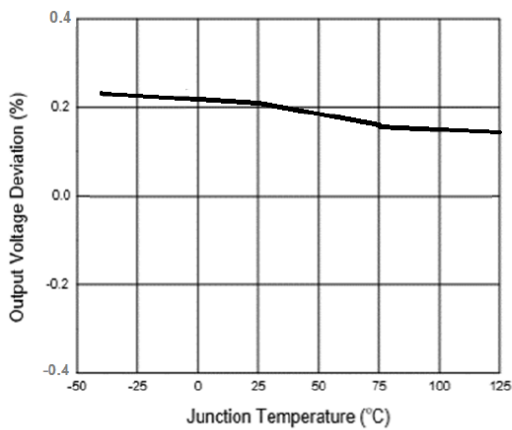

Reference Voltage vs. Junction Temperature

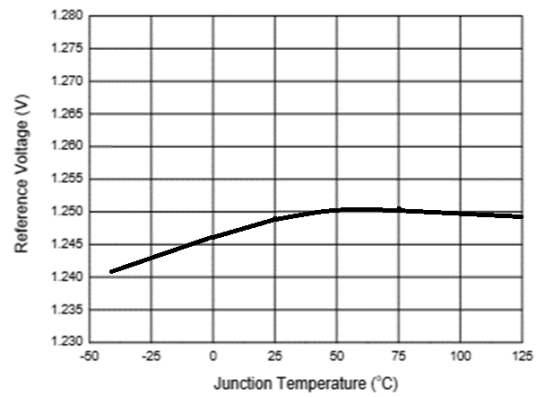

Output Voltage vs. Junction Temperature

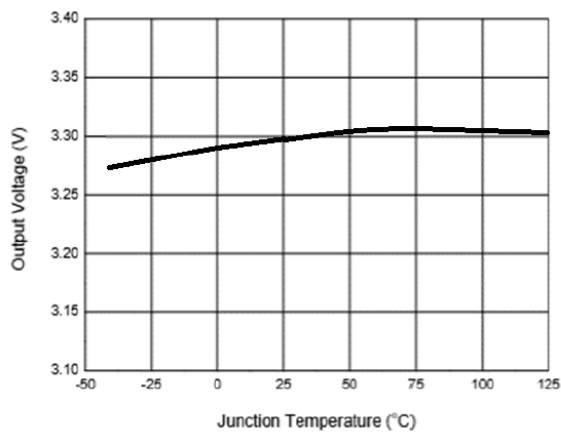

Minimum Load Current vs. Junction Temperature

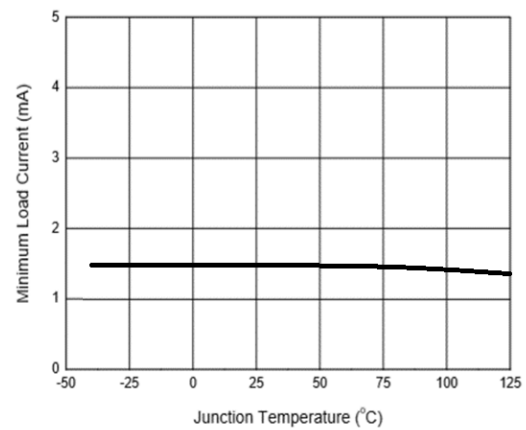

**Adjust Pin Current vs. Junction Temperature**

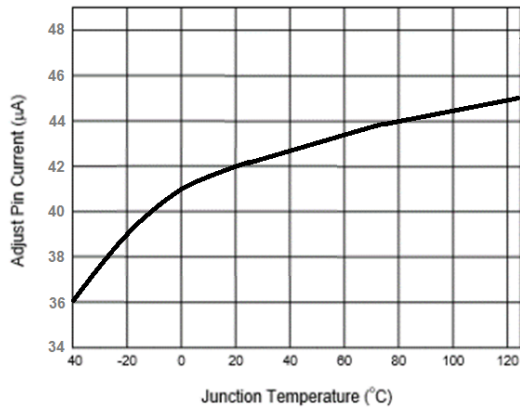

**Short-circuit Current vs. Junction Temperature**

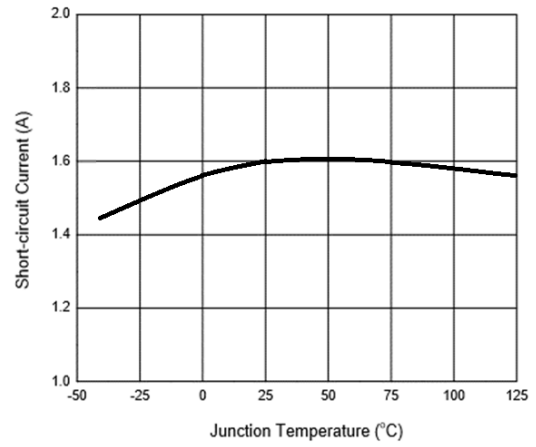

**Ripple Rejection vs. Frequency**

$V_{in}=V_{out}+2.5\text{ V}$ ,  $I_{out}=100\text{mA}$ ,  $C_{out}=10\mu\text{F}$

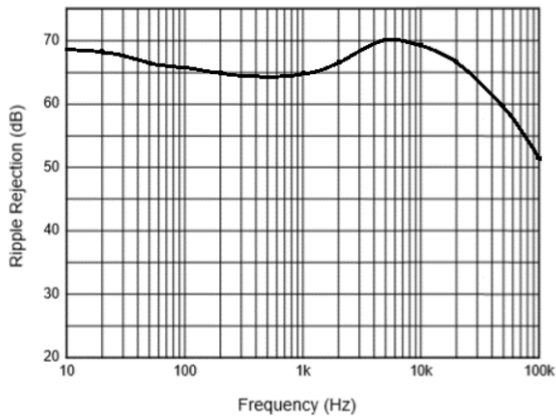

**Derating Curve(S-LR117DD)**

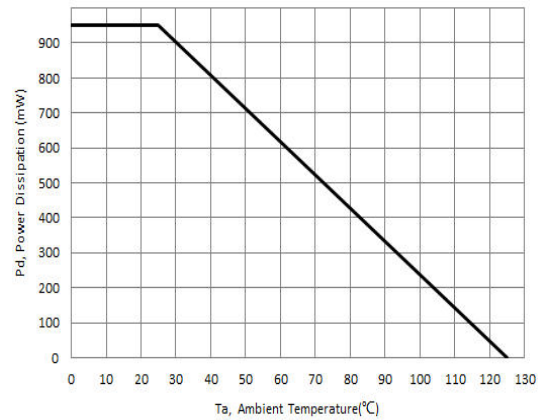

Note: PCB size: 30.0mm×25.0mm×1.6mm(FR4); Copper Foil Thickness: 35µm;

**Derating Curve(S-LR117DS)**

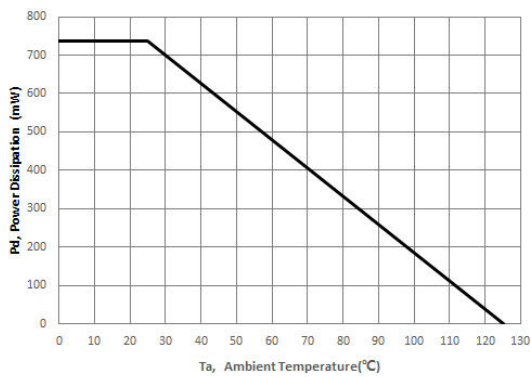

Note: PCB size: 30.0mm×25.0mm×1.6mm(FR4); Copper Foil Thickness: 35µm;



PACKAGE OUTLINE

SOT-223 PACKAGE OUTLINE DIMENSIONS

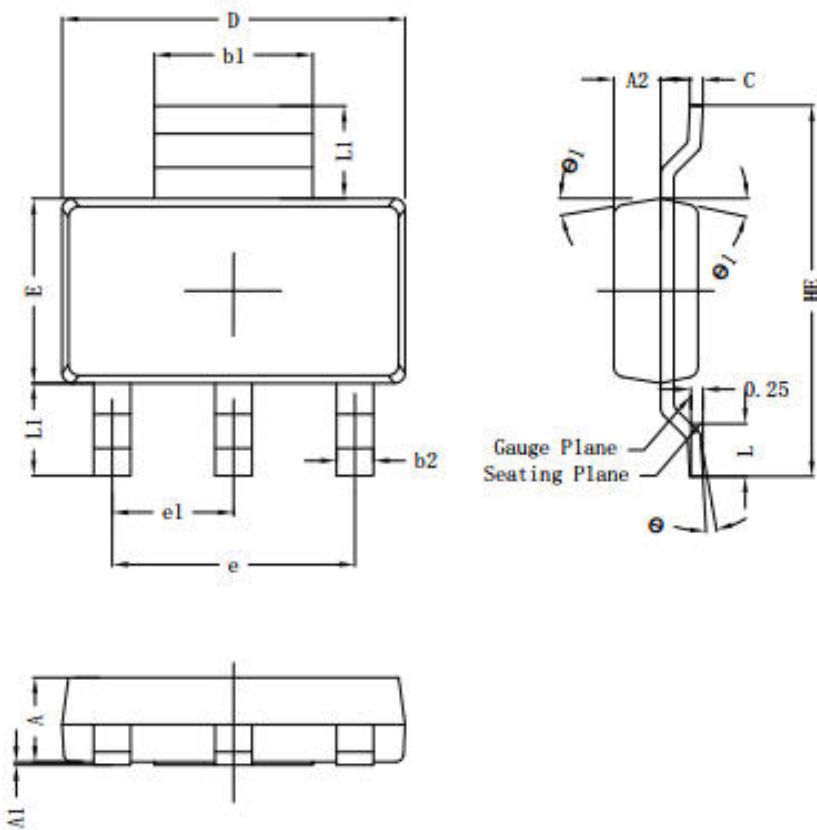

SOT223			
DIM	MIN	NOR	MAX
A	1.50	1.60	1.70
A1	0.00	0.05	0.10
A2	0.80	0.90	1.00
b1	2.90	3.02	3.10
b2	0.60	0.72	0.80
c	0.20	0.27	0.30
D	6.30	6.50	6.70
E	3.30	3.50	3.70
e	4.60BSC		
e1	2.30BSC		
HE	6.80	7.00	7.20
L	0.80	1.00	1.20
L1	1.75(REF)		
θ	0°-8°		
θ 1	8°	10°	12°
All Dimensions in mm			

Suggested Pad layout

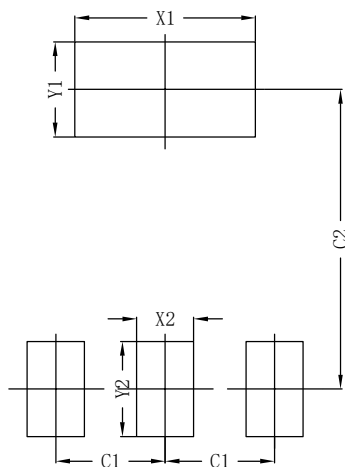

SOT223	
DIM	(mm)
X1	3.80
Y1	2.00
X2	1.20
Y2	2.00
C1	2.30
C2	6.30

TO-252-2L PACKAGE OUTLINE DIMENSIONS

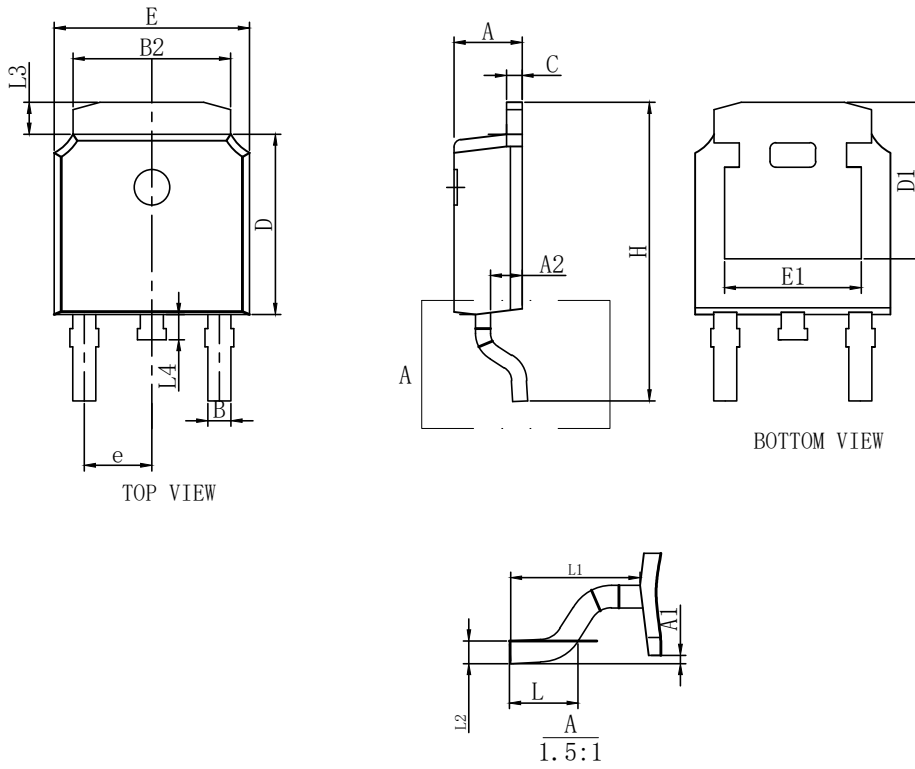

SYMBOL	mm		
	MIN	NOM	MAX
A	2.15	2.30	2.45
A1	0		0.20
A2	0.9	1.07	1.17
B	0.68	0.78	0.88
B2	5.20	5.33	5.46
D	5.90	6.10	6.30
D1	5.30REF		
E	6.40	6.60	6.80
E1	4.63	4.83	5.03
e	2.286BSC		
H	9.8	10.10	10.4
L	1.30	1.50	1.70
L1	2.90REF		
L2	0.51BSC		
L3	0.88	1.08	1.28
L4	0.55	0.80	1.05

Suggested Pad layout

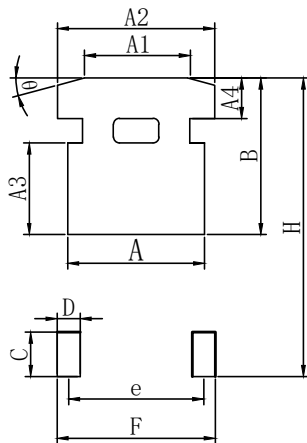

SYMBOL	mm
	MIN
A	6.03
A1	4.50
A2	6.46
A3	4.1
A4	2.37
B	6.50
C	2.50
D	1.68
e	4.80
H	12.35
F	5.95

**DISCLAIMER**

- Curve guarantee in the specification. The curve of test items with electric parameter is used as quality guarantee. The curve of test items without electric parameter is used as reference only.
- Before you use our Products for new Project, you are requested to carefully read this document and fully understand its contents. LRC shall not be in any way responsible or liable for failure, malfunction or accident arising from the use of any LRC's Products against warning, caution or note contained in this document.
- All information contained in this document is current as of the issuing date and subject to change without any prior notice. Before purchasing or using LRC's Products, please confirm the latest information with a LRC sales representative.

单击下面可查看定价，库存，交付和生命周期等信息

[>>LRC\(乐山无线电\)](#)