

Small Signal MOSFET

115 mA, 60V

N-Channel SOT-723

- Pb-Free Package is Available.
- S- Prefix for Automotive and Other Applications Requiring Unique Site and Control Change Requirements; AEC-Q101 Qualified and PPAP Capable.

ORDERING INFORMATION

Device	Marking	Shipping
L2N7002M3T5G S-L2N7002M3T5G	72	8000 Tape & Reel

MAXIMUM RATINGS

Rating	Symbol	Value	Unit
Drain-Source Voltage	V_{DSS}	60	V _{dc}
Drain-Gate Voltage ($R_{GS} = 1.0 M\Omega$)	V_{DGR}	60	V _{dc}
Drain Current - Continuous $T_C = 25^\circ C$ (Note 1.) - Pulse $t < 10\mu s$	I_D I_{DM}	± 115 ± 800	mA _{dc}
Gate-Source Voltage - Continuous	V_{GS}	± 20	V _{dc}

THERMAL CHARACTERISTICS

Characteristic	Symbol	Max	Unit
Total Device Dissipation FR-5 Board (Note 2.) $T_A = 25^\circ C$ Derate above $25^\circ C$	P_D	150 1.2	mW mW/ $^\circ C$
Thermal Resistance, Junction to Ambient	$R_{\theta JA}$	833	$^\circ C/W$
Junction and Storage Temperature	T_J, T_{stg}	-55 to +150	$^\circ C$

1. The Power Dissipation of the package may result in a lower continuous drain current.
2. FR-5 = 1.0 x 0.75 x 0.062 in.
3. Alumina = 0.4 x 0.3 x 0.025 in 99.5% alumina.

L2N7002M3T5G
S-L2N7002M3T5G

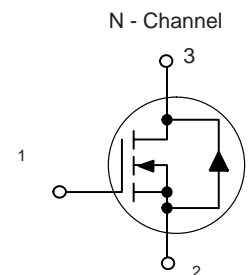
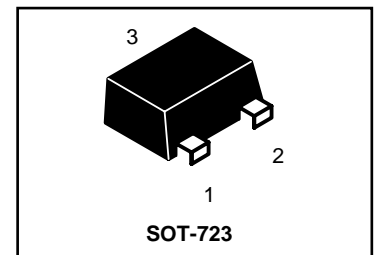

MARKING DIAGRAM & PIN ASSIGNMENT

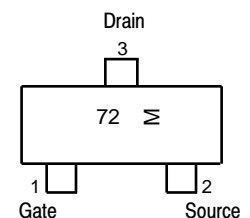

72 = Device Code
M = Month Code

L2N7002M3T5G , S-L2N7002M3T5G
ELECTRICAL CHARACTERISTICS ($T_A = 25^\circ\text{C}$ unless otherwise noted)

Characteristic	Symbol	Min	Typ	Max	Unit
OFF CHARACTERISTICS					
Drain–Source Breakdown Voltage ($V_{GS} = 0, I_D = 10 \mu\text{A}$)	$V_{(BR)DSS}$	60	–	–	Vdc
Zero Gate Voltage Drain Current ($V_{GS} = 0, V_{DS} = 60 \text{ Vdc}$)	I_{DSS}	–	–	1.0 500	μA Adc
Gate–Body Leakage Current, Forward ($V_{GS} = 20 \text{ Vdc}$)	I_{GSSF}	–	–	100	nAdc
Gate–Body Leakage Current, Reverse ($V_{GS} = -20 \text{ Vdc}$)	I_{GSSR}	–	–	-100	nAdc

ON CHARACTERISTICS (Note 2.)

Gate Threshold Voltage ($V_{DS} = V_{GS}, I_D = 250 \mu\text{A}$)	$V_{GS(th)}$	1.0	1.8	2.2	Vdc
On–State Drain Current ($V_{DS} \geq 2.0 V_{DS(on)}, V_{GS} = 10 \text{ Vdc}$)	$I_{D(on)}$	500	–	–	mA
Static Drain–Source On–State Voltage ($V_{GS} = 10 \text{ Vdc}, I_D = 500 \text{ mA}$) ($V_{GS} = 5.0 \text{ Vdc}, I_D = 50 \text{ mA}$)	$V_{DS(on)}$	–	–	3.75 0.375	Vdc
Static Drain–Source On–State Resistance ($V_{GS} = 10 \text{ V}, I_D = 500 \text{ mA}$) ($V_{GS} = 5.0 \text{ Vdc}, I_D = 50 \text{ mA}$)	$r_{DS(on)}$	–	–	4 4	Ohms
Forward Transconductance ($V_{DS} \geq 2.0 V_{DS(on)}, I_D = 200 \text{ mA}$)	g_{FS}	80	–	–	mmhos

DYNAMIC CHARACTERISTICS

Input Capacitance ($V_{DS} = 25 \text{ Vdc}, V_{GS} = 0, f = 1.0 \text{ MHz}$)	C_{iss}	–	17	50	pF
Output Capacitance ($V_{DS} = 25 \text{ Vdc}, V_{GS} = 0, f = 1.0 \text{ MHz}$)	C_{oss}	–	10	25	pF
Reverse Transfer Capacitance ($V_{DS} = 25 \text{ Vdc}, V_{GS} = 0, f = 1.0 \text{ MHz}$)	C_{rss}	–	2.5	5.0	pF

SWITCHING CHARACTERISTICS (Note 2.)

Turn–On Delay Time	($V_{DD} = 25 \text{ Vdc}, I_D \cong 500 \text{ mA}$, $R_G = 25 \Omega, R_L = 50 \Omega, V_{gen} = 10 \text{ V}$)	$t_{d(on)}$	–	7	20	ns
Turn–Off Delay Time		$t_{d(off)}$	–	11	40	ns

BODY–DRAIN DIODE RATINGS

Diode Forward On–Voltage ($I_S = 115 \text{ mA}, V_{GS} = 0 \text{ V}$)	V_{SD}	–	–	1.5	Vdc
Source Current Continuous (Body Diode)	I_S	–	–	115	mA
Source Current Pulsed	I_{SM}	–	–	800	mA

 2. Pulse Test: Pulse Width $\leq 300 \mu\text{s}$, Duty Cycle $\leq 2.0\%$.

L2N7002M3T5G , S-L2N7002M3T5G

TYPICAL ELECTRICAL CHARACTERISTICS

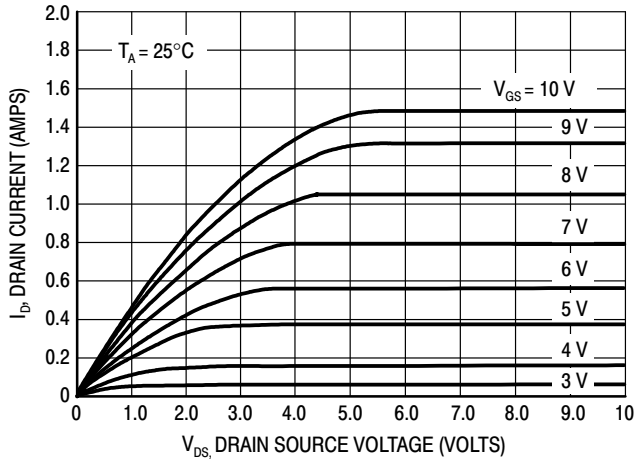

Figure 1. Ohmic Region

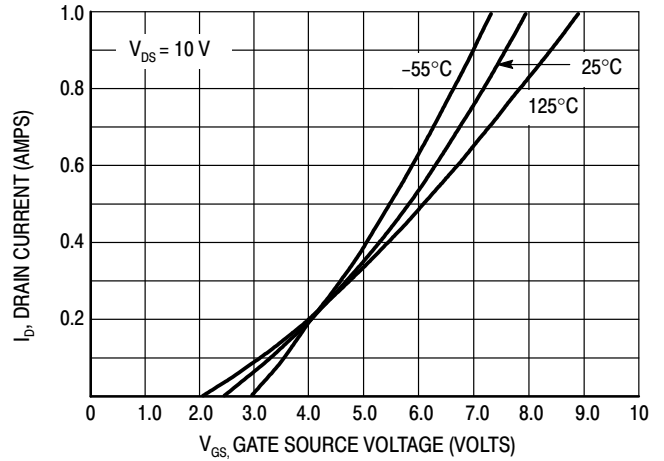

Figure 2. Transfer Characteristics

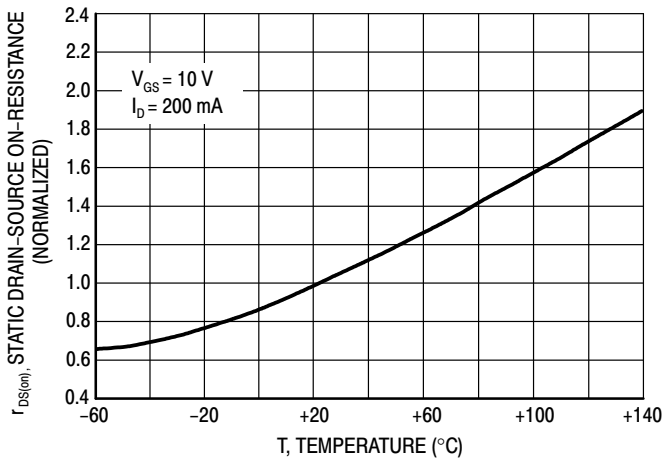

Figure 3. Temperature versus Static Drain-Source On-Resistance

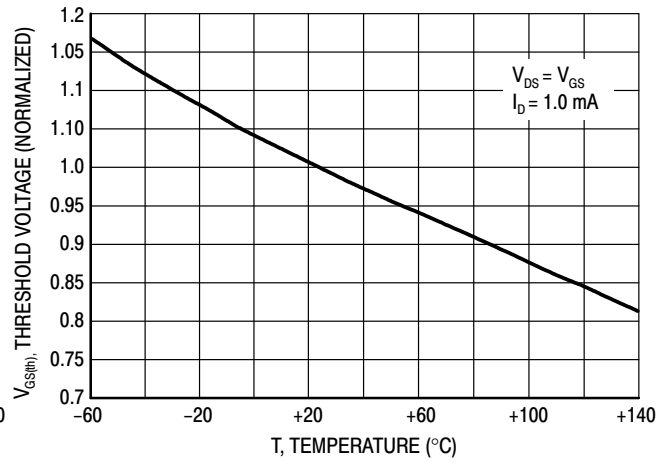
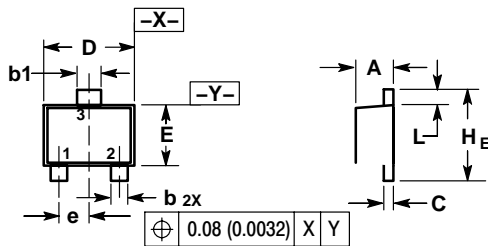
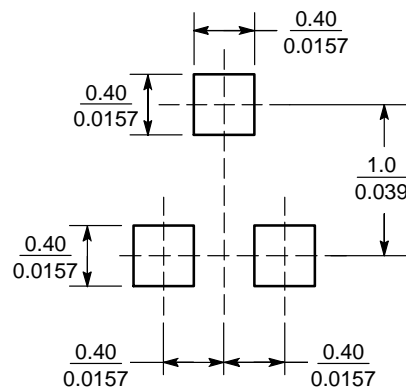

Figure 4. Temperature versus Gate Threshold Voltage

SOT-723

NOTES:

1. DIMENSIONING AND TOLERANCING PER ANSI Y14.5M, 1982.
2. CONTROLLING DIMENSION: MILLIMETERS.
3. MAXIMUM LEAD THICKNESS INCLUDES LEAD FINISH. MINIMUM LEAD THICKNESS IS THE MINIMUM THICKNESS OF BASE MATERIAL.
4. DIMENSIONS D AND E DO NOT INCLUDE MOLD FLASH, PROTRUSIONS OR GATE BURRS.

DIM	MILLIMETERS			INCHES		
	MIN	NOM	MAX	MIN	NOM	MAX
A	0.45	0.50	0.55	0.018	0.020	0.022
b	0.15	0.20	0.27	0.0059	0.0079	0.0106
b1	0.25	0.3	0.35	0.010	0.012	0.014
C	0.07	0.12	0.17	0.0028	0.0047	0.0067
D	1.15	1.20	1.25	0.045	0.047	0.049
E	0.75	0.80	0.85	0.03	0.032	0.034
e	0.40 BSC			0.016 BSC		
H E	1.15	1.20	1.25	0.045	0.047	0.049
L	0.15	0.20	0.25	0.0059	0.0079	0.0098

SOLDERING FOOTPRINT

($\frac{\text{mm}}$
 $\frac{\text{inches}}$)

单击下面可查看定价，库存，交付和生命周期等信息

[>>LRC\(乐山无线电\)](#)