

# Bias Resistor Transistor

## PNP Silicon Surface Mount Transistor with Monolithic Bias Resistor Network

**LDTA114WET1G**

● **Applications**

Inverter, Interface, Driver

● **Features**

- 1) Built-in bias resistors enable the configuration of an inverter circuit without connecting external input resistors.
- 2) The bias resistors consist of thin-film resistors with complete isolation to allow positive biasing of the input, and parasitic effects are almost completely eliminated.
- 3) Only the on / off conditions need to be set for operation, making the device design easy.
- 4) Higher mounting densities can be achieved.

- We declare that the material of product compliance with RoHS requirements.

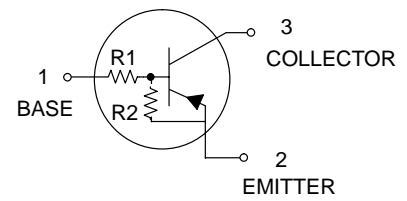
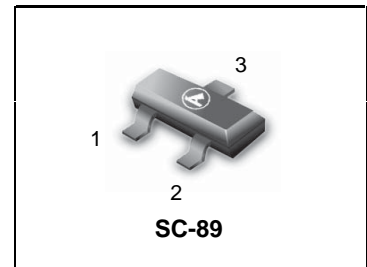

● **Absolute maximum ratings (Ta=25°C)**

Parameter	Symbol	Limits	Unit
Supply voltage	V <sub>CC</sub>	-50	V
Input voltage	V <sub>I</sub>	-30 to +10	V
Output current	I <sub>O</sub>	-100	mA
	I <sub>C(Max.)</sub>	-100	
Power dissipation	P <sub>D</sub>	200	mW
Junction temperature	T <sub>j</sub>	150	°C
Storage temperature	T <sub>stg</sub>	-55 to +150	°C

**DEVICE MARKING AND RESISTOR VALUES**

Device	Marking	R1 (K)	R2 (K)	Shipping
LDTA114WET1G	L6	10	4.7	3000/Tape & Reel
LDTA114WET3G	L6	10	4.7	10000/Tape & Reel

● **External characteristics (Unit: mm)**

Parameter	Symbol	Min.	Typ.	Max.	Unit	Conditions
Input voltage	V <sub>I(off)</sub>	-	-	-0.8	V	V <sub>CC</sub> =-5V, I <sub>O</sub> =-100μA
	V <sub>I(on)</sub>	-3	-	-		V <sub>O</sub> =-0.3V, I <sub>O</sub> =-2mA
Output voltage	V <sub>O(on)</sub>	-	-0.1	-0.3	V	I <sub>O</sub> =-10mA, I <sub>I</sub> =-0.5mA
Input current	I <sub>I</sub>	-	-	-0.88	mA	V <sub>I</sub> =-5V
Output current	I <sub>O(off)</sub>	-	-	-0.5	μA	V <sub>CC</sub> =-50V, V <sub>I</sub> =0V
DC current gain	G <sub>I</sub>	24	-	-	-	I <sub>O</sub> =-10mA, V <sub>O</sub> =-5V
Input resistance	R <sub>I</sub>	7	10	13	kΩ	-
Resistance ratio	R <sub>2</sub> /R <sub>1</sub>	0.37	0.47	0.57	-	-
Transition frequency	f <sub>T</sub> *	-	250	-	MHz	V <sub>CE</sub> =-10V, I <sub>E</sub> =5mA, f=100MHz

\* Characteristics of built-in transistor

**LDTA114WET1G**

● **Electrical characteristics curves**

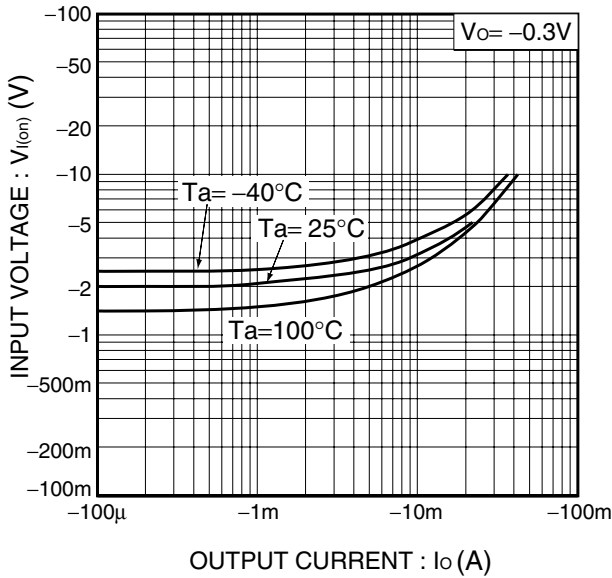

Fig.1 Input voltage vs. Output current (ON characteristics)

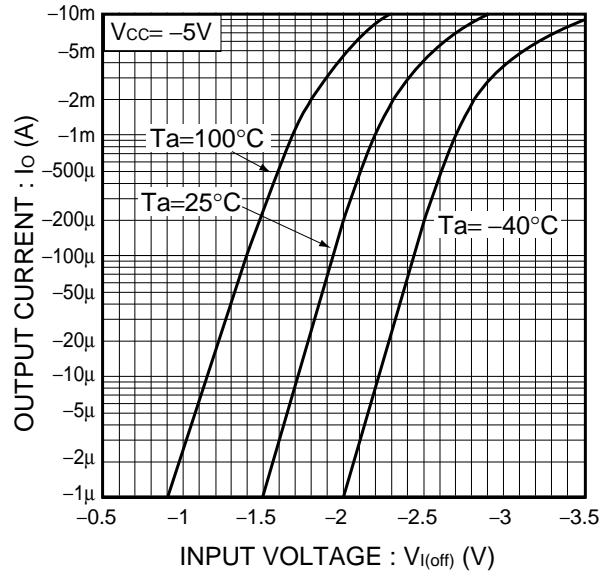

Fig.2 Output current vs. Input voltage (OFF characteristics)

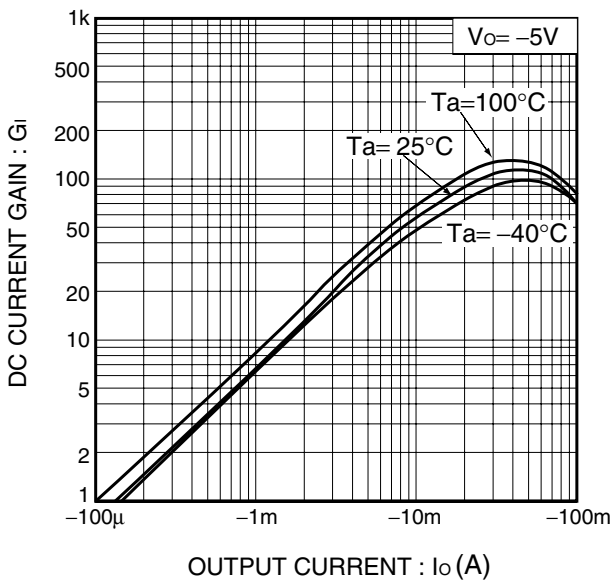

Fig.3 DC current gain vs. Output current

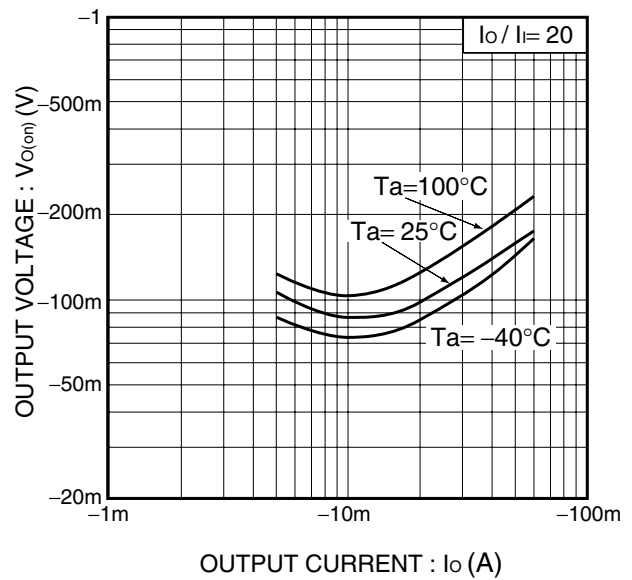
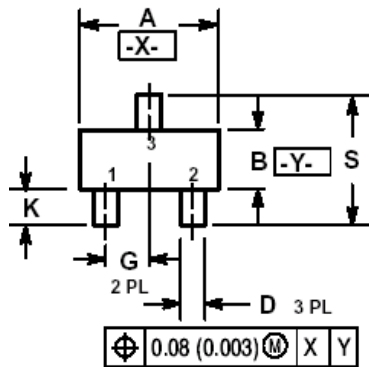

Fig.4 Output voltage vs. Output current

**LDTA114WET1G**

**SC-89**



NOTES:

1. DIMENSIONING AND TOLERANCING PER ANSI Y14.5M, 1982.
2. CONTROLLING DIMENSION: MILLIMETERS
3. MAXIMUM LEAD THICKNESS INCLUDES LEAD FINISH THICKNESS. MINIMUM LEAD THICKNESS IS THE MINIMUM THICKNESS OF BASE MATERIAL.
4. 463C-01 OBSOLETE, NEW STANDARD 463C-02.

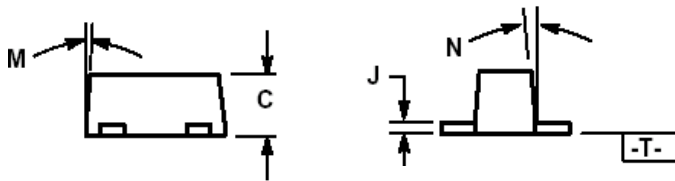

DIM	MILLIMETERS			INCHES		
	MIN	NOM	MAX	MIN	NOM	MAX
A	1.50	1.60	1.70	0.059	0.063	0.067
B	0.75	0.85	0.95	0.030	0.034	0.040
C	0.60	0.70	0.80	0.024	0.028	0.031
D	0.23	0.28	0.33	0.009	0.011	0.013
G	0.50 BSC			0.020 BSC		
H	0.53 REF			0.021 REF		
J	0.10	0.15	0.20	0.004	0.006	0.008
K	0.30	0.40	0.50	0.012	0.016	0.020
L	1.10 REF			0.043 REF		
M	---	---	10 °	---	---	10 °
N	---	---	10 °	---	---	10 °
S	1.50	1.60	1.70	0.059	0.063	0.067

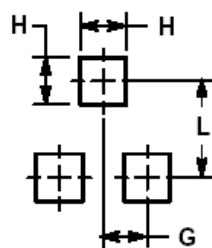

单击下面可查看定价，库存，交付和生命周期等信息

[>>LRC\(乐山无线电\)](#)