

# SMBJ\*\*\* A Series

SURFACE MOUNT TRANSIENT VOLTAGE SUPPRESSOR  
VOLTAGE 5.0 TO 440 Volts, 600 Watt Peak Pulse Power

## 1. FEATURES

- We declare that the material of product compliance with RoHS requirements and Halogen Free.
- Plastic package has Underwriters Laboratory Flammability Classification 94V-O
- For surface mounted applications in order to optimize board space
- Low profile package
- Built-in strain relief
- Glass passivated junction
- Low inductance
- Excellent clamping capability
- Repetition Rate (duty cycle): 0.01%
- Fast response time: typically less than 1.0ps
- Typical IR less than 1mA above 10V
- High temperature soldering guaranteed:  
260°C/10 seconds,
- Weight: 0.088g

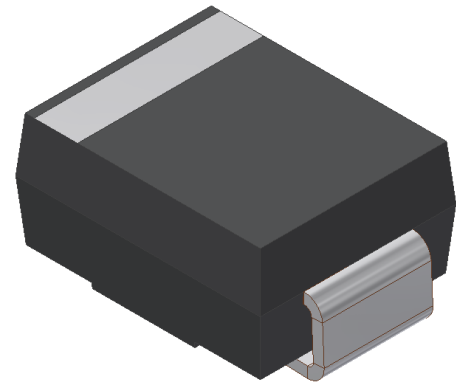

## 2. MECHANICAL DATA

**Case:** Epoxy, Molded

**Terminals:** Plated leads, solderable per MIL-STD-202, Method 208

**Polarity:** With Color band denoted cathode

**Mounting Position:** Any

## 3. MAXIMUM RATINGS (Ta = 25°C)

Ratings at 25°C ambient temperature unless otherwise specified.

Single phase, half wave, 60Hz, resistive or inductive load.

For capacitive load, derate current by 20%.

RATING	VALUE	UNITS
Peak Power Dissipation at $T_A=25^\circ\text{C}$ , $T_P=1\text{ms}$ (Note 1)	Minimum 600	Watts
Steady State Power Dissipation at $T_L=75^\circ\text{C}$ (Note 2)	3.0	Watts
Operating Temperature Range	-55 to +150	°C
Storage Temperature Range	-55 to +150	°C

NOTES:

1. Non-repetitive current pulse, per Fig. 3 and derated above  $T_A=25^\circ\text{C}$  per Fig. 2.
2. Mounted on Copper Leaf area of 1.57in<sup>2</sup>(40mm<sup>2</sup>).
3. 8.3ms single half sine-wave, duty cycle= 4 pulses per minutes maximum.

## SMBJ\*\*\* A Series

Uni-Directional Part Number	Device marking code	Reverse Stand-off Voltage VRWM (V)	Breakdown Voltage VBR (V) Min. @IT	Breakdown Voltage VBR (V) Max. @IT	Test Current IT (mA)	Maximum Clamping Voltage @IPP VC (V)	Peak Pulse Current Ipp (A)	Reverse Leakage @VRWM IR (uA)
SMBJ5.0A	SMBJ5.0A	5.00	6.40	7.00	10.00	9.20	65.30	800
SMBJ6.0A	SMBJ6.0A	6.00	6.67	7.37	10.00	10.30	58.30	800
SMBJ6.5A	SMBJ6.5A	6.50	7.22	7.98	10.00	11.20	53.60	500
SMBJ7.0A	SMBJ7.0A	7.00	7.78	8.60	10.00	12.00	50.00	200
SMBJ7.5A	SMBJ7.5A	7.50	8.33	9.21	1.00	12.90	46.60	100
SMBJ8.0A	SMBJ8.0A	8.00	8.89	9.83	1.00	13.60	44.20	50
SMBJ8.5A	SMBJ8.5A	8.50	9.44	10.40	1.00	14.40	41.70	20
SMBJ9.0A	SMBJ9.0A	9.00	10.00	11.10	1.00	15.40	39.00	10
SMBJ10A	SMBJ10A	10.00	11.10	12.30	1.00	17.00	35.30	1
SMBJ11A	SMBJ11A	11.00	12.20	13.50	1.00	18.20	33.00	1
SMBJ12A	SMBJ12A	12.00	13.30	14.70	1.00	19.90	30.20	1
SMBJ13A	SMBJ13A	13.00	14.40	15.90	1.00	21.50	28.00	1
SMBJ14A	SMBJ14A	14.00	15.60	17.20	1.00	23.20	25.90	1
SMBJ15A	SMBJ15A	15.00	16.70	18.50	1.00	24.40	24.60	1
SMBJ16A	SMBJ16A	16.00	17.80	19.70	1.00	26.00	23.10	1
SMBJ17A	SMBJ17A	17.00	18.90	20.90	1.00	27.60	21.80	1
SMBJ18A	SMBJ18A	18.00	20.00	22.10	1.00	29.20	20.60	1
SMBJ20A	SMBJ20A	20.00	22.20	24.50	1.00	32.40	18.60	1
SMBJ22A	SMBJ22A	22.00	24.40	26.90	1.00	35.50	16.90	1
SMBJ24A	SMBJ24A	24.00	26.70	29.50	1.00	38.90	15.50	1
SMBJ26A	SMBJ26A	26.00	28.90	31.90	1.00	42.10	14.30	1
SMBJ28A	SMBJ28A	28.00	31.10	34.40	1.00	45.40	13.30	1
SMBJ30A	SMBJ30A	30.00	33.30	36.80	1.00	48.40	12.40	1
SMBJ33A	SMBJ33A	33.00	36.70	40.60	1.00	53.30	11.30	1
SMBJ36A	SMBJ36A	36.00	40.00	44.20	1.00	58.10	10.40	1
SMBJ40A	SMBJ40A	40.00	44.40	49.10	1.00	64.50	9.30	1
SMBJ43A	SMBJ43A	43.00	47.80	52.80	1.00	69.40	8.70	1
SMBJ45A	SMBJ45A	45.00	50.00	55.30	1.00	72.70	8.30	1
SMBJ48A	SMBJ48A	48.00	53.30	58.90	1.00	77.40	7.80	1
SMBJ51A	SMBJ51A	51.00	56.70	62.70	1.00	82.40	7.30	1
SMBJ54A	SMBJ54A	54.00	60.00	66.30	1.00	87.10	6.90	1
SMBJ58A	SMBJ58A	58.00	64.40	71.20	1.00	93.60	6.50	1
SMBJ60A	SMBJ60A	60.00	66.70	73.70	1.00	96.80	6.20	1
SMBJ64A	SMBJ64A	64.00	71.10	78.60	1.00	103.00	5.90	1
SMBJ70A	SMBJ70A	70.00	77.80	86.00	1.00	113.00	5.30	1
SMBJ75A	SMBJ75A	75.00	83.30	92.10	1.00	121.00	5.00	1
SMBJ78A	SMBJ78A	78.00	86.70	95.80	1.00	126.00	4.80	1
SMBJ85A	SMBJ85A	85.00	94.40	104.00	1.00	137.00	4.40	1
SMBJ90A	SMBJ90A	90.00	100.00	111.00	1.00	146.00	4.10	1
SMBJ100A	SMBJ100A	100.00	111.00	123.00	1.00	162.00	3.70	1
SMBJ110A	SMBJ110A	110.00	122.00	135.00	1.00	177.00	3.40	1
SMBJ120A	SMBJ120A	120.00	133.00	147.00	1.00	193.00	3.10	1
SMBJ130A	SMBJ130A	130.00	144.00	159.00	1.00	209.00	2.90	1
SMBJ150A	SMBJ150A	150.00	167.00	185.00	1.00	243.00	2.50	1
SMBJ160A	SMBJ160A	160.00	178.00	197.00	1.00	259.00	2.30	1
SMBJ170A	SMBJ170A	170.00	189.00	209.00	1.00	275.00	2.20	1
SMBJ180A	SMBJ180A	180.00	198.00	221.00	1.00	291.00	2.10	1
SMBJ190A	SMBJ190A	190.00	209.00	233.00	1.00	307.00	2.00	1
SMBJ200A	SMBJ200A	200.00	220.00	246.00	1.00	324.00	1.90	1
SMBJ220A	SMBJ220A	220.00	246.00	272.00	1.00	356.00	1.70	1
SMBJ250A	SMBJ250A	250.00	279.00	309.00	1.00	405.00	1.50	1
SMBJ300A	SMBJ300A	300.00	335.00	371.00	1.00	486.00	1.30	1
SMBJ350A	SMBJ350A	350.00	391.00	432.00	1.00	567.00	1.10	1
SMBJ400A	SMBJ400A	400.00	447.00	494.00	1.00	648.00	0.90	1
SMBJ440A	SMBJ440A	440.00	492.00	543.00	1.00	713.00	0.90	1

### 5. ELECTRICAL CHARACTERISTICS CURVES

Fig. 1-Peak Pulse Power Rating Curve

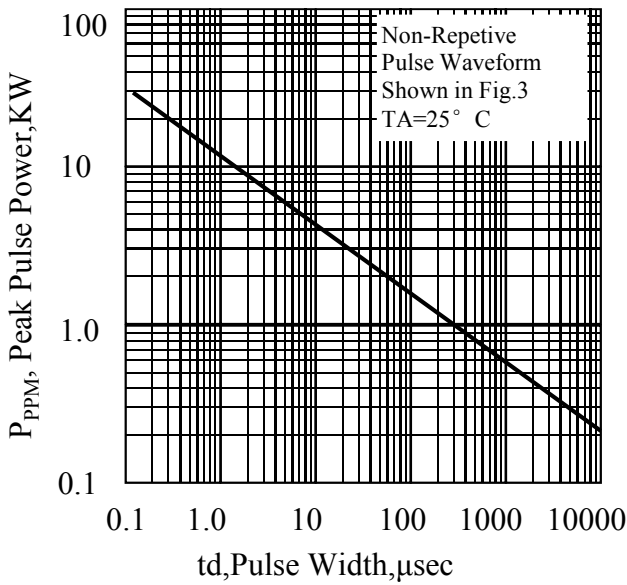

Fig. 2-Pulse Derating Curve

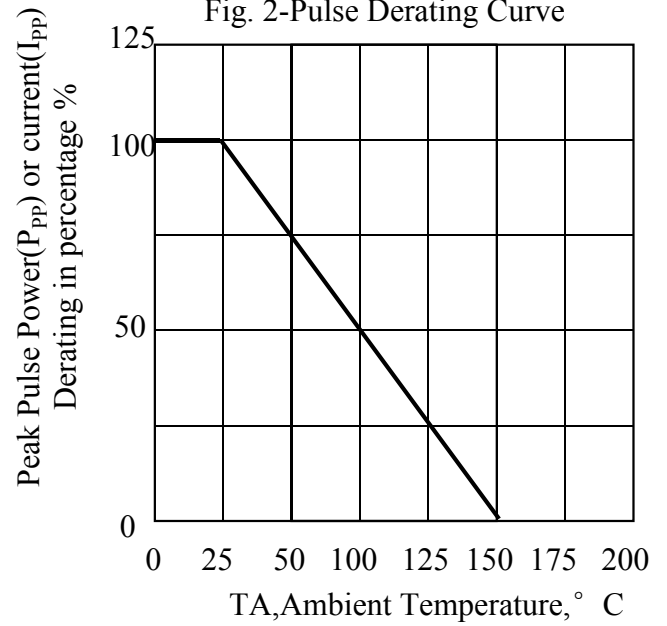

Fig. 3-Pulse Waveform

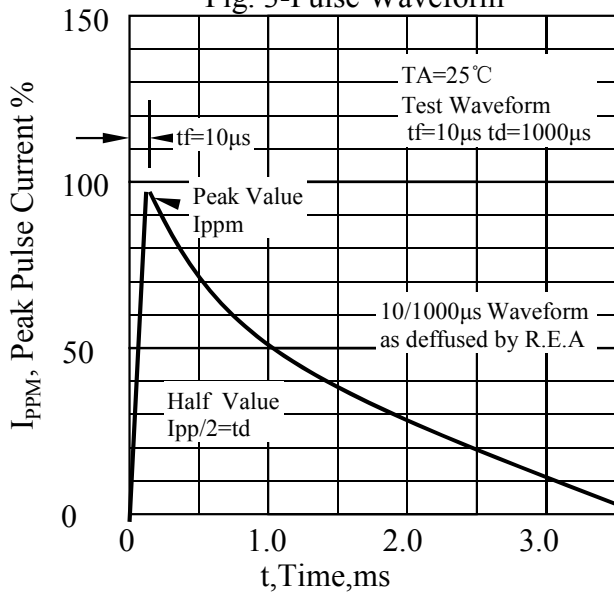
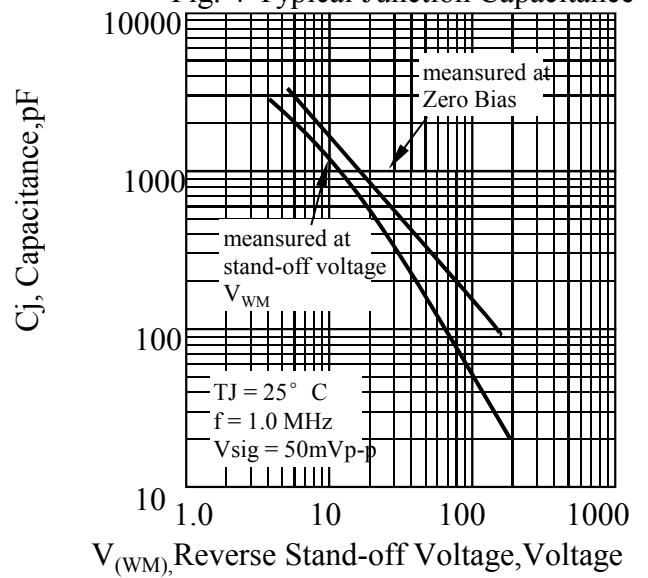
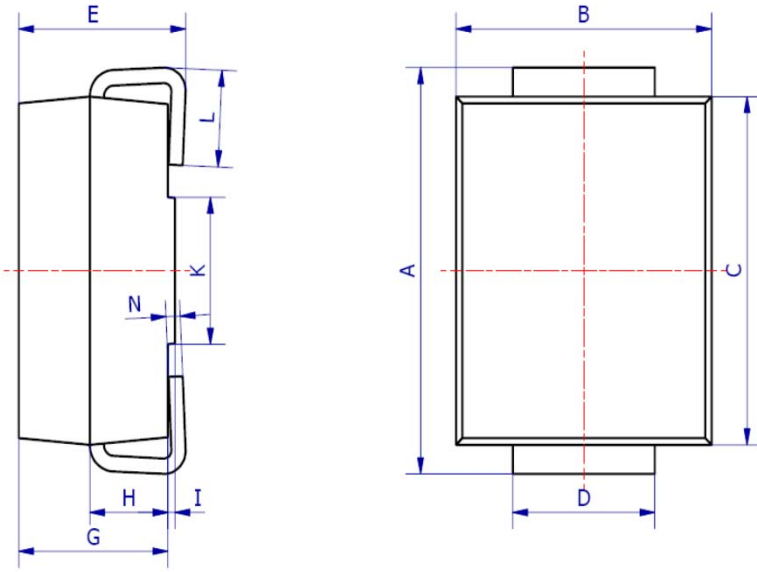

Fig. 4-Typical Junction Capacitance



### 6. OUTLINE AND DIMENSIONS



SMB			
DIM	Min	Max	Typ.
A	5.00	5.45	5.25
B	3.20	4.00	3.60
C	4.30	4.70	4.50
D	1.80	2.20	2.00
E	2.20	2.50	2.35
G	1.90	2.30	2.10
H	0.95	1.25	1.10
I	0.05	0.15	0.10
K	1.70	2.10	1.90
L	0.90	1.50	1.20
N	0.10	0.30	0.20
All Dimensions in mm			

### 7. SOLDERING FOOTPRINT

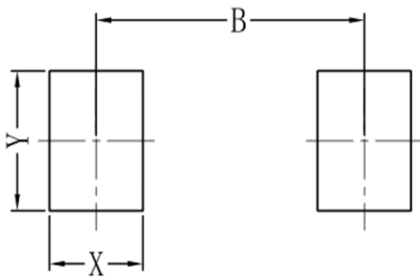

SMB	
DIM	(mm)
X	1.60
Y	2.20
B	4.60

单击下面可查看定价，库存，交付和生命周期等信息

[>>LRC\(乐山无线电\)](#)