

LN76076DT1WG

100V N-Channel Power MOSFET

1. FEATURES

- Low thermal impedance.
- Fast switching.
- We declare that the material of product compliance with RoHS requirements and Halogen Free.

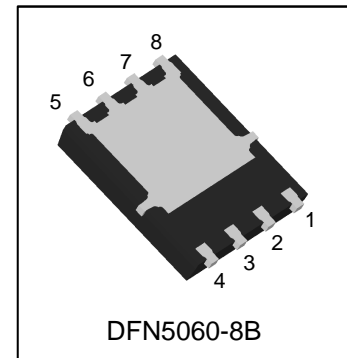

2. APPLICATIONS

- Power Tools
- UPS
- Motor Control

3. DEVICE MARKING AND RESISTOR VALUES

Device	Marking	Shipping
LN76076DT1WG	LN76076	3000/Tape&Reel

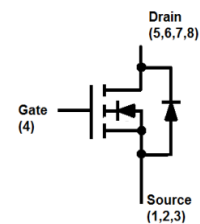

4. MAXIMUM RATINGS(Ta = 25°C)

Parameter		Symbol	Limits	Unit
Drain-to-Source Voltage		VDS	100	V
Gate-to-Source Voltage		VGS	±20	V
Continuous Drain Current(Note 1)	TA=25°C	ID	16.5	A
	TA=75°C		13	
	TC=25°C		85	
	TC=75°C		66	
Pulsed Drain Current (Note 2)		IDM	66	A
Avalanche Current		IAS	15	A
Avalanche Energy(L=0.1mH)		EAS	11.25	mJ
Power Dissipation(Note 1)	TA=25°C	PD	2.5	W
	TC=25°C		62.5	
Operating Junction and Storage Temperature Range		Tj/Tstg	-55~+150	°C

5. THERMAL CHARACTERISTICS

Parameter	Symbol	Max	Unit
Thermal Resistance,Junction-to-Ambient(Note 1)	RθJA	50	°C/W
Thermal Resistance,Junction-to-Ambient(Note 3)	RθJA	100	
Thermal Resistance,Junction-to-Case	RθJC	2	

- 1.Surface mounted on 1.5 x 1.5 FR4 board using 1 sq in pad, 2 oz Cu.
- 2.Pulse width limited by maximum junction temperature.
- 3.Surface mounted on FR4 board using the minimum recommended pad size.

6. ELECTRICAL CHARACTERISTICS (Ta= 25°C)

Characteristic	Symbol	Min.	Typ.	Max.	Unit
Static					
Drain–Source Breakdown Voltage (VGS = 0 V, ID = 250μA)	VBRDSS	100	-	-	V
Gate Threshold Voltage (VDS = VGS , ID = 250 uA)	VGS(th)	1.2	-	2.5	V
Gate-Body leakage current (VDS = 0 V, VGS = ±20V)	IGSS	-	-	±100	nA
Zero Gate Voltage Drain Current (VDS = 80 V, VGS = 0 V)	IDSS	-	-	1	μA
Drain-to-Source On-Resistance (Note 4) (VGS = 10 V, ID = 20 A) (VGS = 4.5 V, ID = 10 A)	RDS(ON)	- -	- -	8 10	mΩ
Diode Forward Voltage (IS = 2 A, VGS = 0 V)	VSD	-	-	1.2	V
Dynamic					
Total Gate Charge	(VDS = 50 V, VGS = 10 V, ID = 20 A)	Qg	-	36	nC
Gate to Source Charge		Qgs	-	4.7	
Gate to Drain Charge		Qgd	-	13.5	
Turn-on Delay Time	(VDS = 50V, ID =20 A, VGS =10 V, RG = 6 Ω, RL = 2.5 Ω)	td(on)	-	12	nS
Rise Time		tr	-	18	
Turn-Off Delay Time		td(off)	-	78	
Fall Time		tf	-	42	
Input Capacitance	(VDS = 50 V, VGS = 0 V, f = 100 kHz)	Ciss	-	2148	pF
Output Capacitance		Coss	-	370	
Reverse Transfer Capacitance		Crss	-	7	

4. Pulse test: PW ≤ 300μs duty cycle ≤ 2%.

7. ELECTRICAL CHARACTERISTICS CURVES

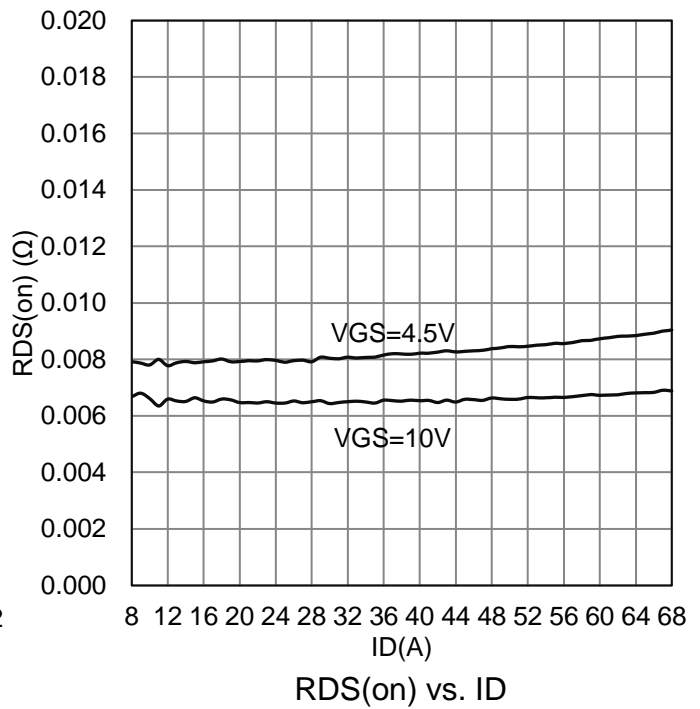
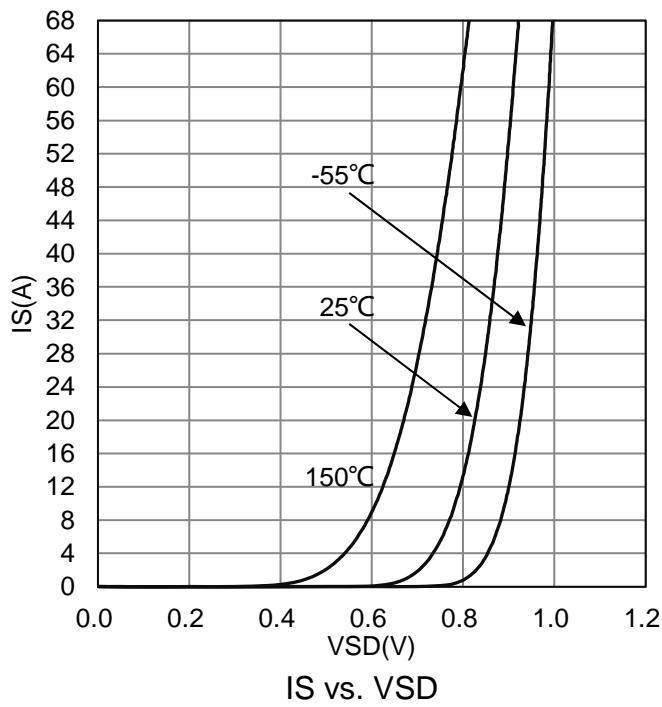
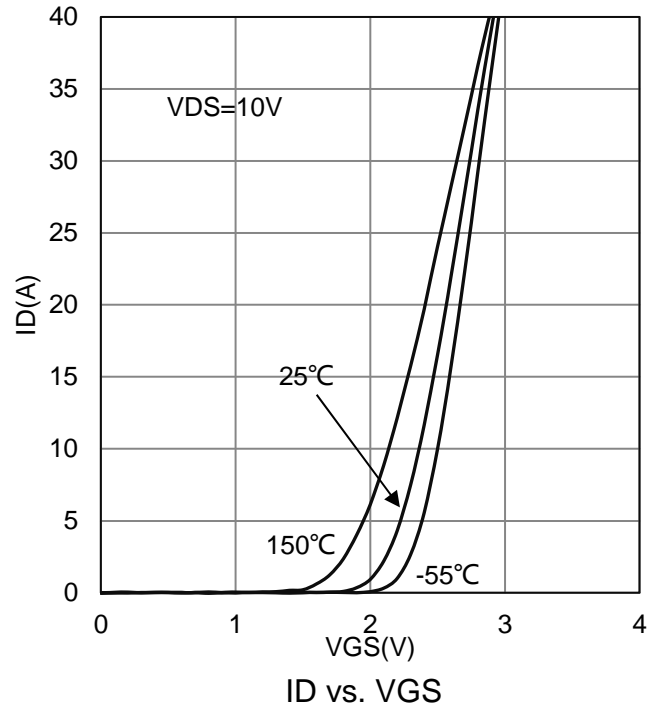
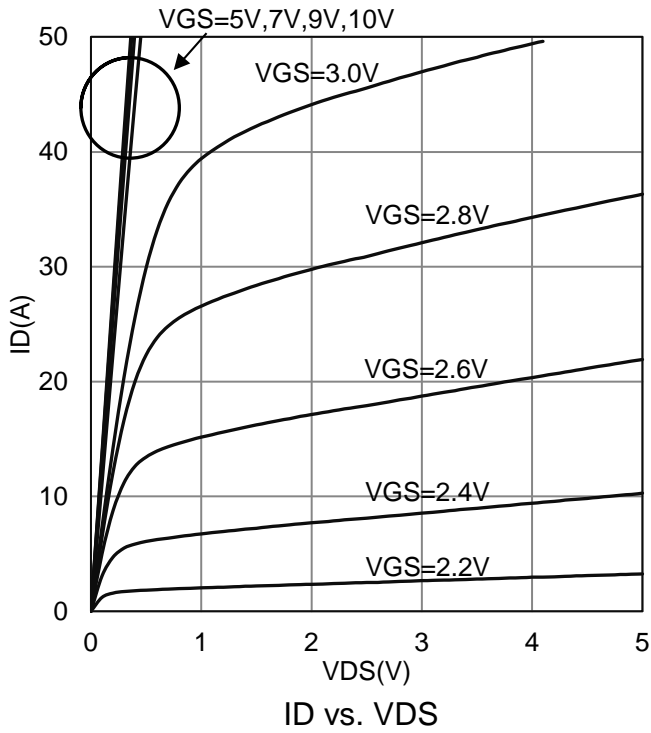

7. ELECTRICAL CHARACTERISTICS CURVES(Con.)

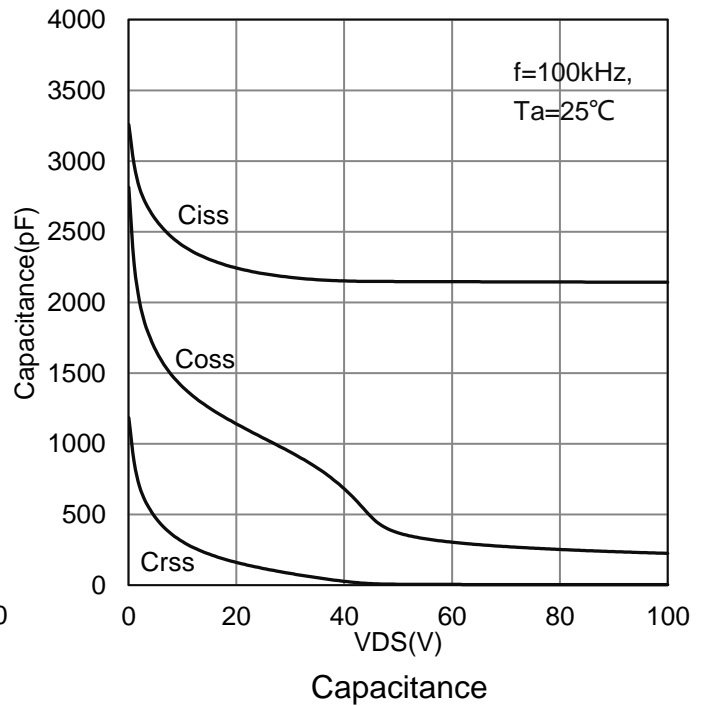
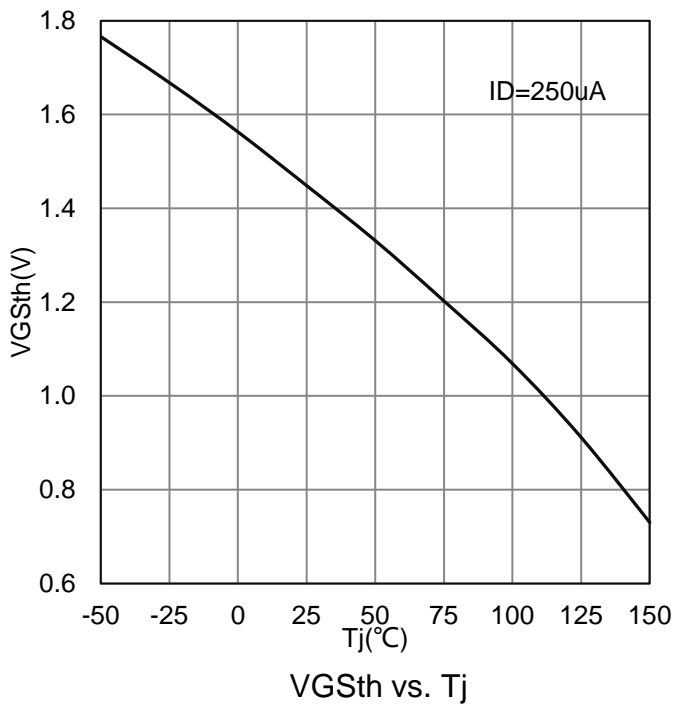
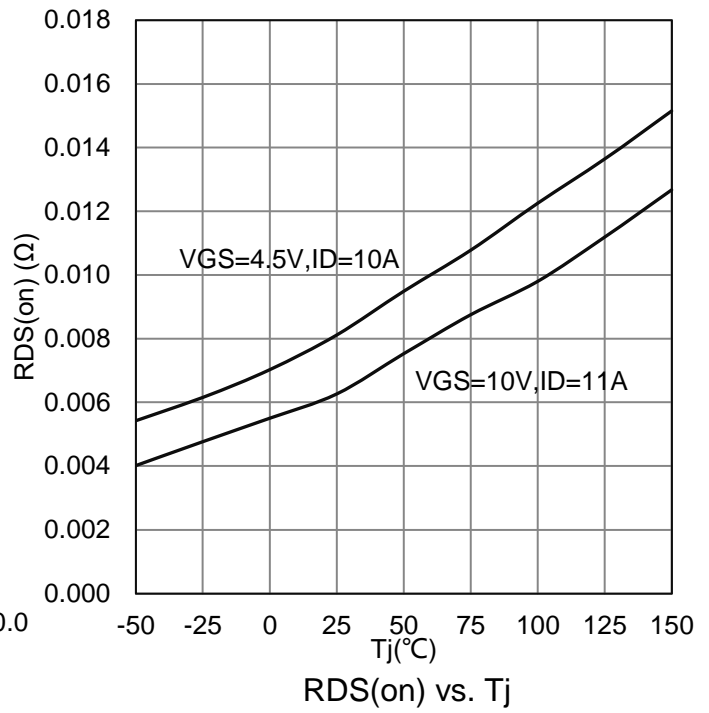
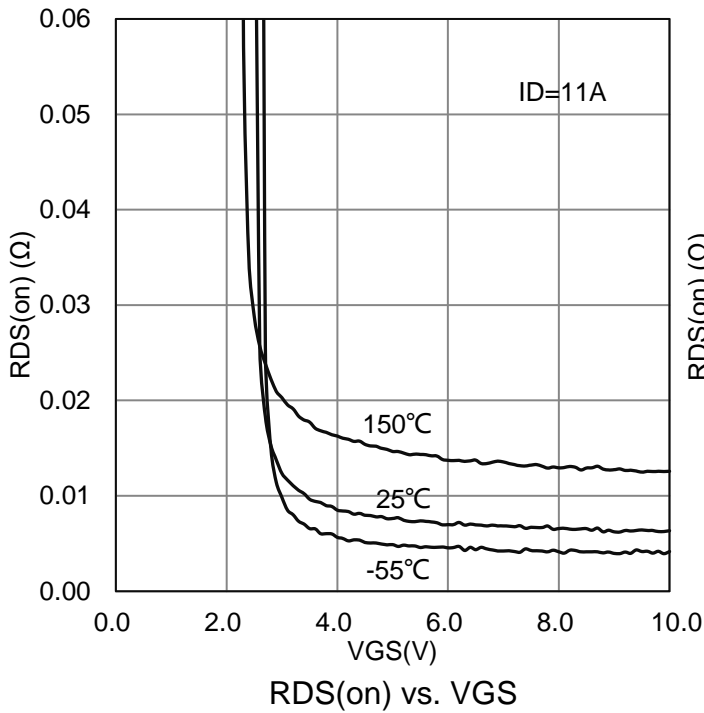

7. ELECTRICAL CHARACTERISTICS CURVES(Con.)

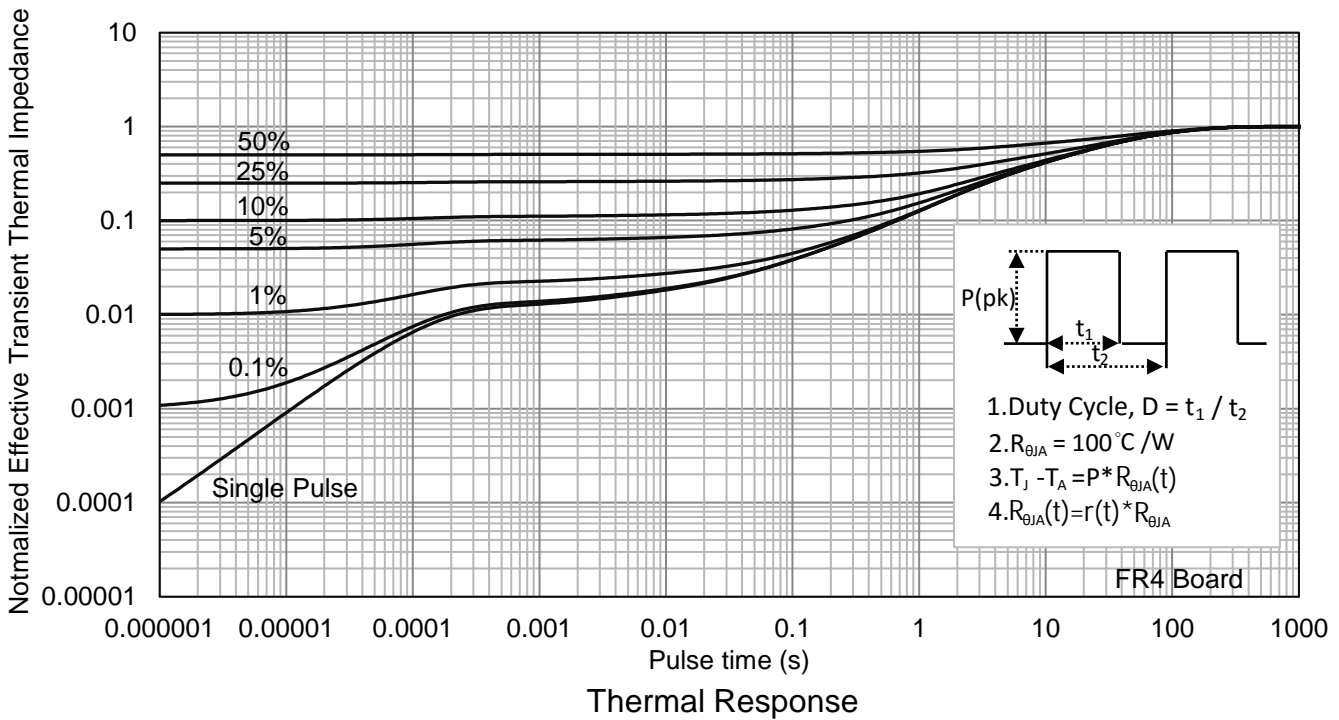
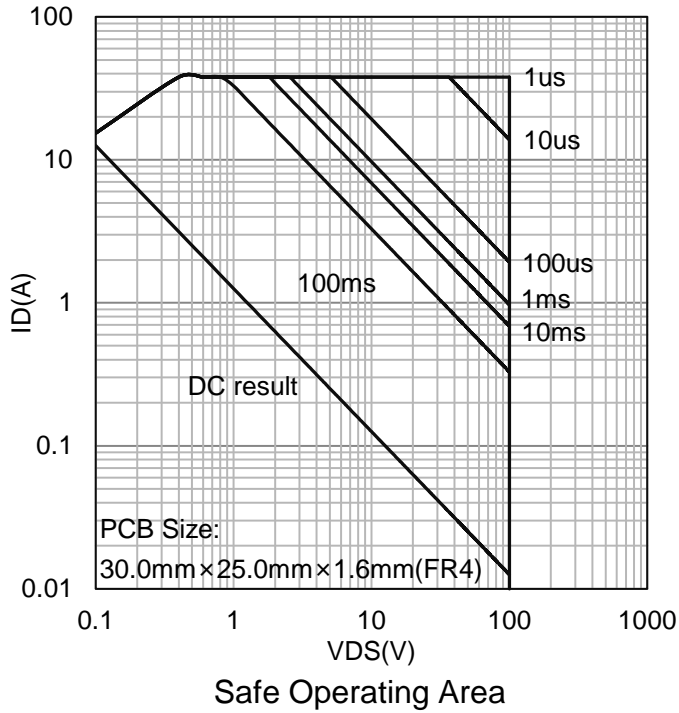

8. OUTLINE AND DIMENSIONS

DFN5060-8B

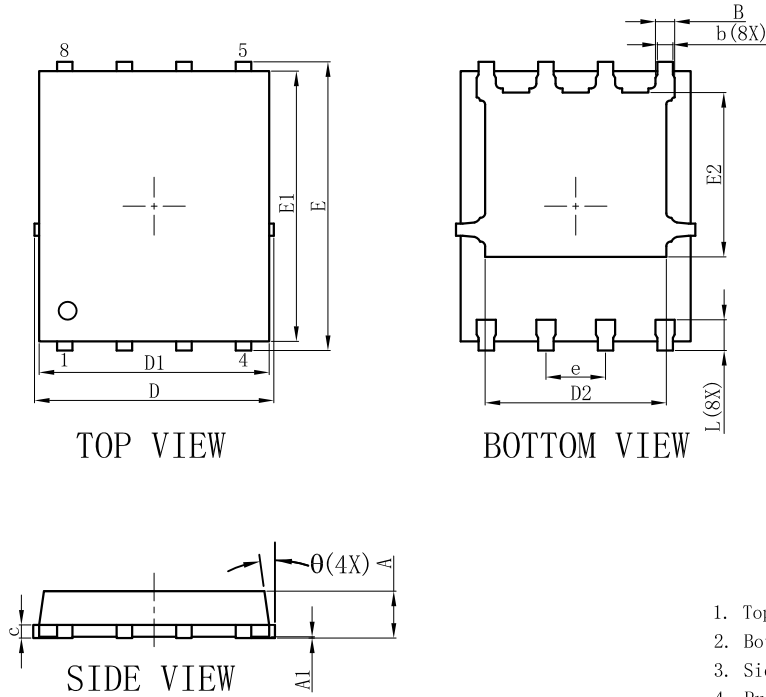

DFN5060-8B			
DIM	MIN	NOR	MAX
A	0.90	1.00	1.10
A1	0.00	0.02	0.05
E	6.00	6.15	6.30
E1	5.66	5.76	5.86
E2	3.40	3.50	3.60
D	4.95	5.10	5.25
D1	4.80	4.90	5.00
D2	3.76	3.86	3.96
b	0.30	0.35	0.40
B	0.36	0.41	0.46
L	0.56	0.66	0.76
e	1.27BSC		
c	0.254REF.		
θ	0°	-	12°
All Dimensions in mm			

GENERAL NOTES

1. Top package surface finish Ra0.4±0.2um
2. Bottom package surface finish Ra0.7±0.2um
3. Side package surface finish Ra0.4±0.2um
4. Protrusion or Gate Burrs shall not exceed 0.05mm per side.
5. Offcenter Max0.038mm; Mismatch Max 0.038mm.

9. SOLDERING FOOTPRINT

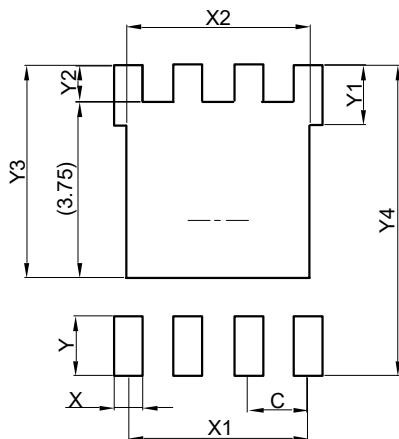

DFN5060-8B	
DIM	(mm)
C	1.27
X	0.61
X1	3.81
X2	3.91
Y	1.27
Y1	1.27
Y2	0.77
Y3	4.52
Y4	6.61

DISCLAIMER

- Before you use our Products, you are requested to carefully read this document and fully understand its contents. LRC shall not be in any way responsible or liable for failure, malfunction or accident arising from the use of any LRC's Products against warning, caution or note contained in this document.
- All information contained in this document is current as of the issuing date and subject to change without any prior notice. Before purchasing or using LRC's Products, please confirm the latest information with a LRC sales representative.

单击下面可查看定价，库存，交付和生命周期等信息

[>>LRC\(乐山无线电\)](#)