

SODJ*****(C)**A-SH

SURFACE MOUNT TRANSIENT VOLTAGE SUPPRESSOR

200 Watt Peak Pulse Power

Features

- * For surface mounted applications in order to optimize board space
- * Low profile package
- * Excellent clamping capability
- * IEC61000-4-2 ESD 15kV Air,8kV contact compliance
- * Protects one I/O line
- * Lead-free parts meet RoHS requirements
- * Suffix "-SH" indicates Halogen-free part, ex.SODJ5.0A-SH.

Applications

- * Personal digital assistants (PDA)
- * Cellular handsets & Accessories
- * Portable devices
- * Portable instrumentation
- * Handhelds and notebooks
- * Digital cameras

Mechanical data

- * **Epoxy** : UL94-V0 rated flame retardant
- * **Case** : Molded plastic, SOD123-FL/MINI SMA
- * **Terminals** :Plated terminals, solderable per MIL-STD-750,Method 2026
- * **Polarity** : Indicated by cathode band; Bidirectional without color band.
- * **Mounting Position** : Any
- * **Weight** :15mg

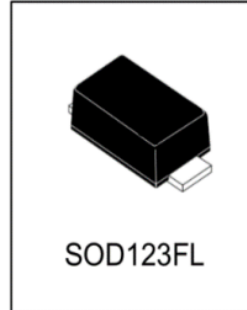

We declare that the material of product is
Halogen free (green epoxy compound)

1.Maximum ratings and Electrical Characteristics(AT T =25 AoC unless otherwise noted)

PARAMETER	SYMBOL	VALUE	UNITS
Peak Power Dissipation at $T_A=25^{\circ}\text{C}$, $T_P=1\text{ms}$ (Note 1)	P_{PPM}	Minimum 200	Watts
Steady State Power Dissipation at $T_C=75^{\circ}\text{C}$ (Note 2)	$P_{M(AV)}$	0.5	Watts
Peak Forward Surge Current, 8.3ms Single Half Sine-wave Unidirectional Only, Superimposed on Rated Load(JECED Method) (Note 3)	I_{FSM}	20	Amps
Operating Temperature Range	T_J ,	-55 to +150	$^{\circ}\text{C}$
Storage Temperature Range	T_{STG}	-55 to +150	$^{\circ}\text{C}$

NOTES:

1. Non-repetitive current pulse, per Fig. 3 and derated above $T_A=25^{\circ}\text{C}$ per Fig. 2.
2. 8.0mm² (.013mm thick) land areas
3. 8.3ms single half sine-wave, duty cycle= 4 pulses per minutes maximum.

SODJ*****(C)**A-SH

UNI-DIRECTIONAL PART NUMBER	Bidirectional-DIRECTIONAL PART NUMBER	REVERSE STAND-OFF VOLTAGE VRWM (V)	BREAKDOWN VOLTAGE VBR (V) MIN. @IT	BREAKDOWN VOLTAGE VBR (V) MAX. @IT	TEST CURRENT IT (mA)	MAXIMUM CLAMPING VOLTAGE @IPP VC (V)	REVERSE LEAKAGE @VRWM IR (uA)	IPPM (A)	Marking Code	
									Uni	Bi
SODJ5.0A-SH	SODJ5.0CA-SH	5	6.4	7	10	9.2	400	21.7	KE	AE
SODJ6.0A-SH	SODJ6.0CA-SH	6	6.67	7.37	10	10.3	400	19.4	KG	AG
SODJ6.5A-SH	SODJ6.5CA-SH	6.5	7.22	7.98	10	11.2	250	17.9	KK	AK
SODJ7.0A-SH	SODJ7.0CA-SH	7	7.78	8.6	10	12	100	16.7	KM	AM
SODJ7.5A-SH	SODJ7.5CA-SH	7.5	8.33	9.21	1	12.9	50	15.5	KP	AP
SODJ8.0A-SH	SODJ8.0CA-SH	8	8.89	9.83	1	13.6	25	14.7	KR	AR
SODJ8.5A-SH	SODJ8.5CA-SH	8.5	9.44	10.4	1	14.4	10	13.9	KT	AT
SODJ9.0A-SH	SODJ9.0CA-SH	9	10	11.1	1	15.4	5	13	KV	AV
SODJ10A-SH	SODJ10CA-SH	10	11.1	12.3	1	17	2.5	11.8	KX	AX
SODJ11A-SH	SODJ11CA-SH	11	12.2	13.5	1	18.2	2.5	11	KZ	AZ
SODJ12A-SH	SODJ12CA-SH	12	13.3	14.7	1	19.9	2.5	10.1	LE	BE
SODJ13A-SH	SODJ13CA-SH	13	14.4	15.9	1	21.5	1	9.3	LG	BG
SODJ14A-SH	SODJ14CA-SH	14	15.6	17.2	1	23.2	1	8.6	LK	BK
SODJ15A-SH	SODJ15CA-SH	15	16.7	18.5	1	24.4	1	8.2	LM	BM
SODJ16A-SH	SODJ16CA-SH	16	17.8	19.7	1	26	1	7.7	LP	BP
SODJ17A-SH	SODJ17CA-SH	17	18.9	20.9	1	27.6	1	7.2	LR	BR
SODJ18A-SH	SODJ18CA-SH	18	20	22.1	1	29.2	1	6.8	LT	BT
SODJ20A-SH	SODJ20CA-SH	20	22.2	24.5	1	32.4	1	6.2	LV	BV
SODJ22A-SH	SODJ22CA-SH	22	24.4	26.9	1	35.5	1	5.6	LX	BX
SODJ24A-SH	SODJ24CA-SH	24	26.7	29.5	1	38.9	1	5.1	LZ	BZ
SODJ26A-SH	SODJ26CA-SH	26	28.9	31.9	1	42.1	1	4.8	ME	CE
SODJ28A-SH	SODJ28CA-SH	28	31.1	34.4	1	45.4	1	4.4	MG	CG
SODJ30A-SH	SODJ30CA-SH	30	33.3	36.8	1	48.4	1	4.1	MK	CK
SODJ33A-SH	SODJ33CA-SH	33	36.7	40.6	1	53.3	1	3.8	MM	CM
SODJ36A-SH	SODJ36CA-SH	36	40	44.2	1	58.1	1	3.4	MP	CP
SODJ40A-SH	SODJ40CA-SH	40	44.4	49.1	1	64.5	1	3.1	MR	CR
SODJ43A-SH	SODJ43CA-SH	43	47.8	52.8	1	69.4	1	2.9	MT	CT
SODJ45A-SH	SODJ45CA-SH	45	50	55.3	1	72.7	1	2.8	MV	CV
SODJ48A-SH	SODJ48CA-SH	48	53.3	58.9	1	77.4	1	2.6	MX	CX
SODJ51A-SH	SODJ51CA-SH	51	56.7	62.7	1	82.4	1	2.4	MZ	CZ
SODJ54A-SH	SODJ54CA-SH	54	60	66.3	1	87.1	1	2.3	NE	DE
SODJ58A-SH	SODJ58CA-SH	58	64.4	71.2	1	93.6	1	2.1	NG	DG
SODJ60A-SH	SODJ60CA-SH	60	66.7	73.7	1	96.8	1	2.1	NK	DK
SODJ64A-SH	SODJ64CA-SH	64	71.1	78.6	1	103	1	1.9	NM	DM
SODJ70A-SH	SODJ70CA-SH	70	77.8	86	1	113	1	1.8	NP	DP
SODJ75A-SH	SODJ75CA-SH	75	83.3	92.1	1	121	1	1.7	NR	DR
SODJ78A-SH	SODJ78CA-SH	78	86.7	95.8	1	126	1	1.6	NT	DT
SODJ85A-SH	SODJ85CA-SH	85	94.4	104	1	137	1	1.5	NV	DV
SODJ90A-SH	SODJ90CA-SH	90	100	111	1	146	1	1.4	NX	DX
SODJ100A-SH	SODJ100CA-SH	100	111	123	1	162	1	1.2	NZ	DZ
SODJ110A-SH	SODJ110CA-SH	110	122	135	1	177	1	1.1	PE	EE
SODJ120A-SH	SODJ120CA-SH	120	133	147	1	193	1	1.0	PG	EG
SODJ130A-SH	SODJ130CA-SH	130	144	159	1	209	1	1.0	PK	EK
SODJ150A-SH	SODJ150CA-SH	150	167	185	1	243	1	0.8	PM	EM
SODJ160A-SH	SODJ160CA-SH	160	178	197	1	259	1	0.8	PP	EP
SODJ170A-SH	SODJ170CA-SH	170	189	209	1	275	1	0.7	PR	ER
SODJ180A-SH	SODJ180CA-SH	180	198	221	1	291	1	0.7	PT	ET
SODJ190A-SH	SODJ190CA-SH	190	209	233	1	307	1	0.7	PV	EV
SODJ200A-SH	SODJ200CA-SH	200	220	246	1	324	1	0.6	PX	EX
SODJ220A-SH	SODJ220CA-SH	220	246	272	1	356	1	0.56	PY	EY

SODJ^{***}(C)A-SH

2. Ratings and Characteristic Curves (TA = 25°C unless otherwise noted)

Fig. 1-Peak Pulse Power Rating Curve

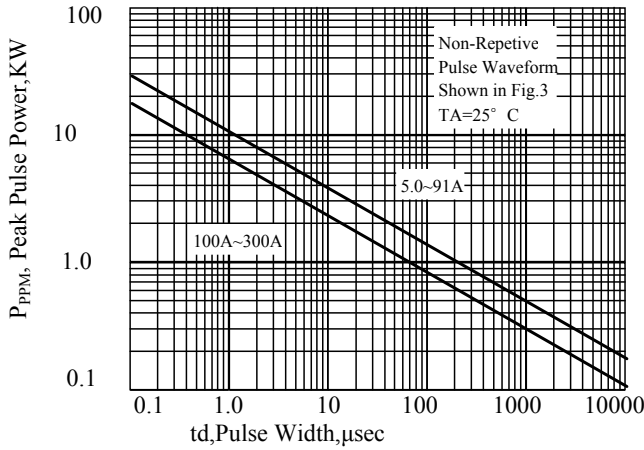

Fig. 2-Power Derating Curve

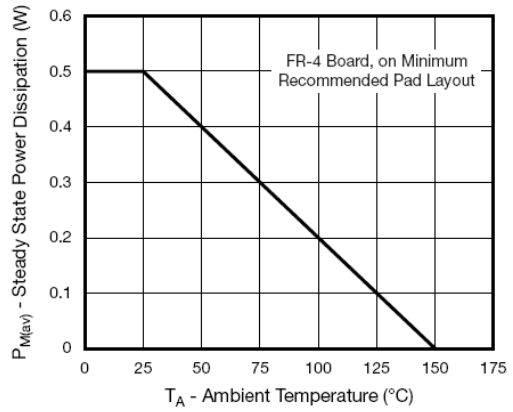

Fig. 3-Pulse Waveform

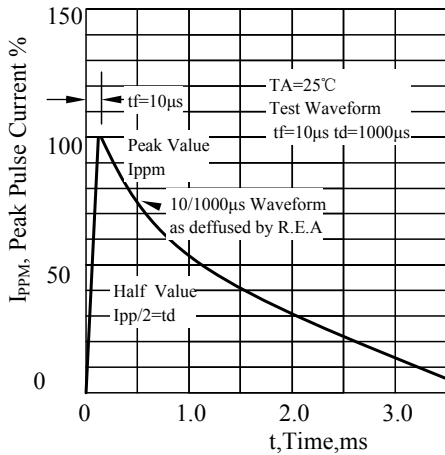

Fig. 4-Typical Junction Capacitance Unidirectional

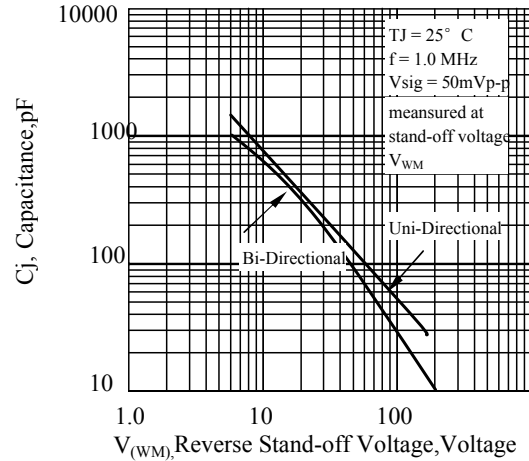

Fig 5 - typical transient thermal impedance

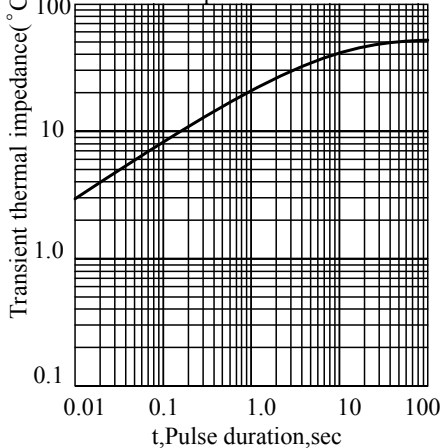
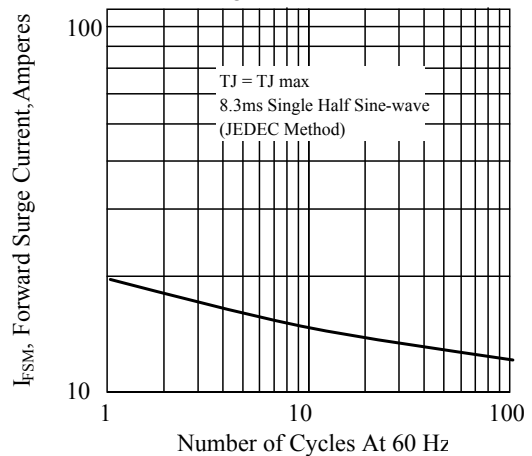
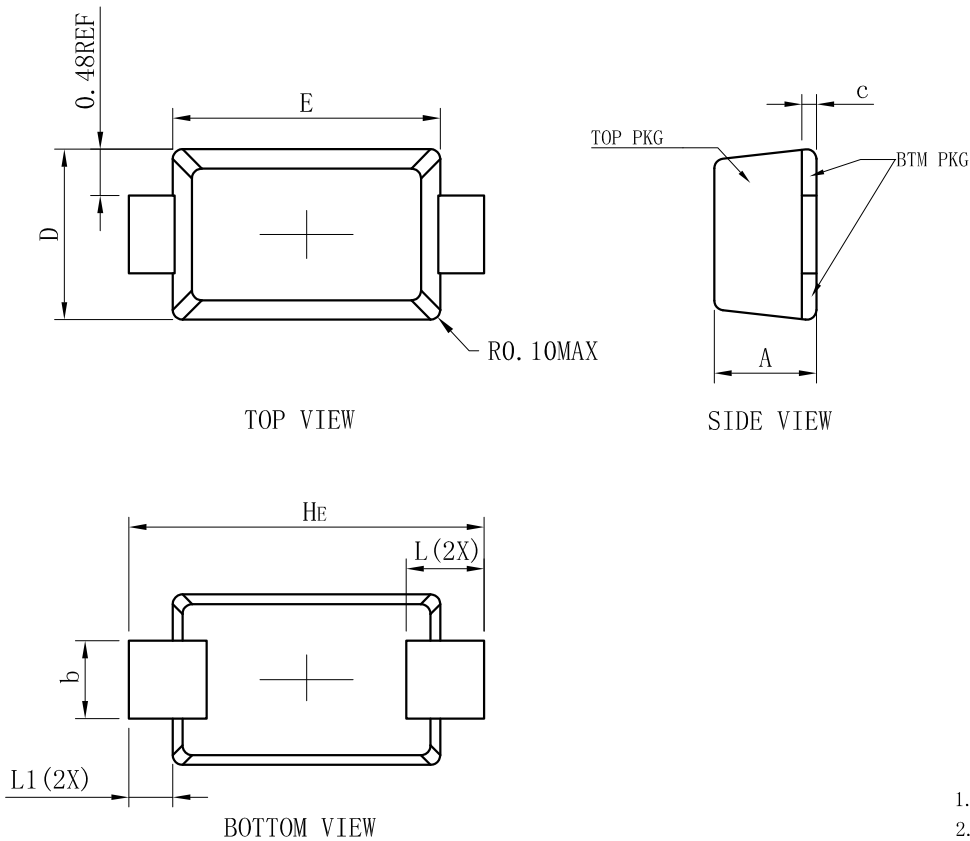

Fig. 6-Maximum Non-Repetitive Peak Forward Surge Current Unidirectional



3. dimension:



SOD123FL			
DIM	MIN	NOR	MAX
A	0.90	1.05	1.15
b	0.75	0.80	0.95
L	0.50	0.80	1.10
E	2.60	2.75	2.90
D	1.60	1.75	1.90
HE	3.50	3.65	3.80
c	0.12	0.17	0.22
L1	0.25	0.45	0.65
All Dimensions in mm			

GENERAL NOTES

1. Top package surface finish $Ra0.4 \pm 0.2\mu m$
2. Bottom package surface finish $Ra0.7 \pm 0.2\mu m$
3. Side package surface finish $Ra0.4 \pm 0.2\mu m$

Suggested solder pad layout

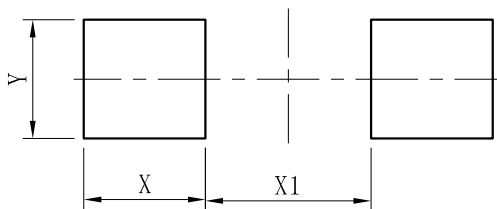

DIM	(mm)
X	1.20
Y	1.10
X1	2.00

DISCLAIMER

- Before you use our Products, you are requested to carefully read this document and fully understand its contents. LRC shall not be in any way responsible or liable for failure, malfunction or accident arising from the use of any LRC's Products against warning, caution or note contained in this document.
- All information contained in this document is current as of the issuing date and subject to change without any prior notice. Before purchasing or using LRC's Products, please confirm the latest information with a LRC sales representative.



Proprietary Information

Title: Power Packages Product Packing Specification

功率产品包装规范

Document Number: APS-QA-QS-009

Revision C

Page 3 of 6



8.1.2 Label position and QA stamp position.(Empty area) 标签张贴位置及QA印章位置。(印章盖 标签空白区)



7英寸卷盘标签张贴及QA印章位置



13英寸卷盘标签张贴及QA印章位置

8.1.3 Ensure direction In the same reel. The same steel coil plate direction, With antistatic bubble to package reel. Refer to the below picture.

同一箱内的卷盘方向一致,用防静电泡沫对卷盘进行包裹。

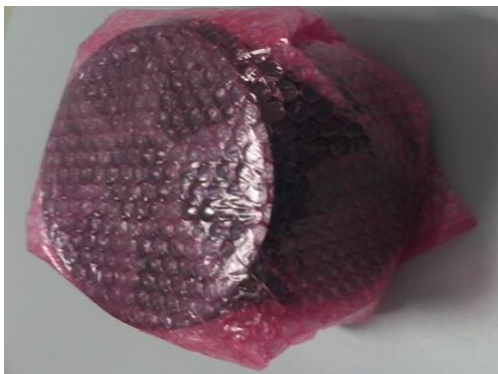

7英寸卷盘防静电泡沫包裹



13英寸卷盘防静电泡沫包裹

Do not copy without written permission from Advanced Power Semiconductor



Proprietary Information

Title: Power Packages Product Packing Specification

功率产品包装规范

Document Number: APS-QA-QS-009

Revision C

Page 4 of 6

8.1.4 Put in the antistatic packing box after packaged reels. And QA stamp on the box label .

将包装好的卷盘放入防静电纸箱中，并 盒标签上盖章。



7 英寸卷盘内盒及标签



13 英寸卷盘内盒及标签

8.1.5 Product use printing inner box. 产品使用LRC印字内箱。



7英寸卷盘内箱印字（侧面）



13英寸卷盘内箱印字（正面）

8.1.6 Inner box packing quantity requirement. 内盒包装数量要求。

Product Description	QTY
SOD123-FL	1-10Reels
SOD323-HE	1-10Reels
SMA-FL	1-7Reels
SMB-FL	1-4Reels

8.1.7 With transparent tape sealing. 透明胶带封箱。

Do not copy without written permission from Advanced Power Semiconductor



Proprietary Information

Title: Power Packages Product Packing Specification

功率产品包装规范

Document Number: APS-QA-QS-009

Revision C

Page 5 of 6



7英寸内箱封盒



13英寸内箱封盒

8.1.8 Outer box size and packing quantity requirement, 外箱尺寸及包装数量要求。

Product Description	卷盘尺寸	Height (H)	Width (W)	Length (L)	Max. Qty
Power Device	7 英寸	410mm	400mm	445mm	12
Power Device	13 英寸	410mm	400mm	445mm	5



7 英寸卷盘产品装箱



13 英寸卷盘产品装箱

统一方向

Do not copy without written permission from Advanced Power Semiconductor



Proprietary Information

Title: Power Packages Marking & Taping Specification

功率封装字模和编带规范

Document Number: APS-QA-QS-010

Revision C

Page 6 of 9

8.2 Standard Products Taping Specification

标准产品编带规范

8.2.1 Tape length of no component

空带长度说明

Taping leader length 引导部分: $440\text{mm} \pm 40\text{mm}$, Tape trailer 尾部: $200\text{mm} \pm 40\text{mm}$

Figure 4

Tape Ends For Finished Goods Reel

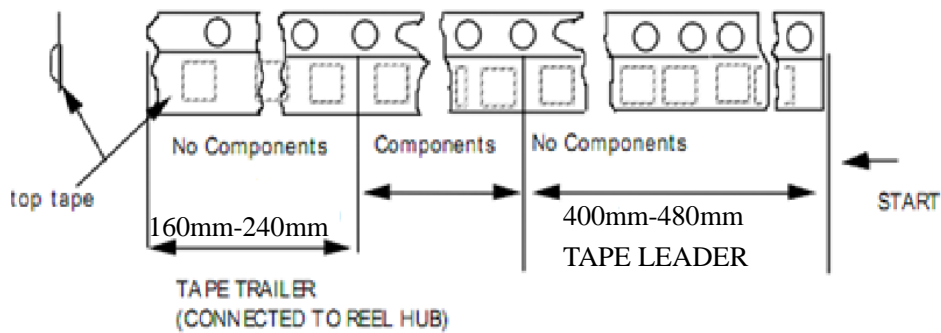

8.2.2 Component packaging orientation: The cathode lead is close to the carrier tape's index hole.

产品放置方向: 印阴极带引脚邻近载带索引孔



Do not copy without written permission from Advanced Power Semiconductor



Proprietary Information

Title: Power Packages Marking & Taping Specification

功率封装字模和编带规范

Document Number: APS-QA-QS-010

Revision C

Page 7 of 9

8.2.3 Tape enwind orientation

编带缠绕方向要求



Do not copy without written permission from Advanced Power Semiconductor

单击下面可查看定价，库存，交付和生命周期等信息

[>>LRC\(乐山无线电\)](#)