

LBC846BLT1G

S-LBC846BLT1G

General Purpose Transistors NPN Silicon

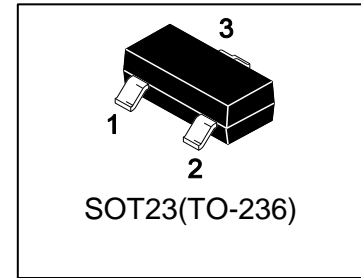

1. FEATURES

- Moisture Sensitivity Level: 1
- ESD Rating – Human Body Model: >4000 V
– Machine Model: >400 V
- We declare that the material of product compliance with RoHS requirements and Halogen Free.
- S- prefix for automotive and other applications requiring unique site and control change requirements; AEC-Q101 qualified and PPAP capable.

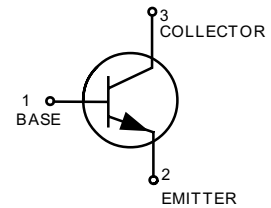

2. DEVICE MARKING AND ORDERING INFORMATION

Device	Marking	Shipping
LBC846BLT1G	1B	3000/Tape&Reel
LBC846BLT3G	1B	10000/Tape&Reel

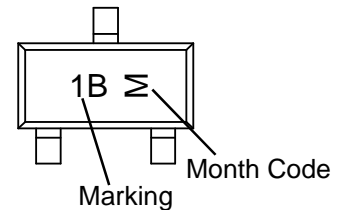

3. MAXIMUM RATINGS(Ta = 25°C)

Parameter	Symbol	Limits	Unit
Collector–Emitter Voltage	VCEO	65	V
Collector–Base Voltage	VCBO	80	V
Emitter–Base Voltage	VEBO	6	V
Collector Current — Continuous	IC	100	mA

4. THERMAL CHARACTERISTICS

Parameter	Symbol	Limits	Unit
Total Device Dissipation, FR-5 Board (Note 1) @ TA = 25°C Derate above 25°C	PD	225 1.8	mW mW/°C
Thermal Resistance, Junction–to–Ambient(Note 1)	RθJA	556	°C/W
Junction and Storage temperature	TJ, Tstg	-55~+150	°C

1. FR-5 = 1.0×0.75×0.062 in.

5. ELECTRICAL CHARACTERISTICS (Ta= 25°C)

OFF CHARACTERISTICS

Characteristic	Symbol	Min.	Typ.	Max.	Unit
Collector–Emitter Breakdown Voltage (IC = 10 mA)	VBR(CEO)	65	-	-	V
Collector–Emitter Breakdown Voltage (IC = 10 μA, VEB = 0)	VBR(CES)	80	-	-	V
Collector–Base Breakdown Voltage (IC = 10 μA)	VBR(CBO)	80	-	-	V
Emitter–Base Breakdown Voltage (IE = 1.0 μA)	VBR(EBO)	6	-	-	V
Collector Cutoff Current (VCB = 30 V)	ICBO	-	-	15	nA
(VCB = 30 V, TA = 150°C)		-	-	5	μA

ON CHARACTERISTICS

DC Current Gain (IC = 2.0 mA, VCE = 5.0 V)	HFE	200	290	450	
Collector–Emitter Saturation Voltage (IC = 10 mA, IB = 0.5 mA)	VCE(sat)	-	-	0.25	V
(IC = 100 mA, IB = 5.0 mA)		-	-	0.6	
Base–Emitter Saturation Voltage (IC = 10 mA, IB = 0.5 mA)	VBE(sat)	-	0.7	-	V
(IC = 100 mA, IB = 5.0 mA)		-	0.9	-	
Base–Emitter Voltage (IC = 2.0 mA, VCE = 5.0 V)	VBE(on)	580	660	700	mV
(IC = 10 mA, VCE = 5.0 V)		-	-	770	

SMALL–SIGNAL CHARACTERISTICS

Current–Gain — Bandwidth Product (IC = 10 mA, VCE = 5.0 V, f = 100 MHz)	fT	100	-	-	MHz
Output Capacitance (VCB = 10 V, f = 1.0 MHz)	Cobo	-	-	4.5	pF
Noise Figure (IC = 0.2 mA, VCE = 5.0 V, RS = 2.0 kΩ f = 1.0 kHz, BW = 200 Hz)	NF	-	-	10	dB

6.ELECTRICAL CHARACTERISTICS CURVES

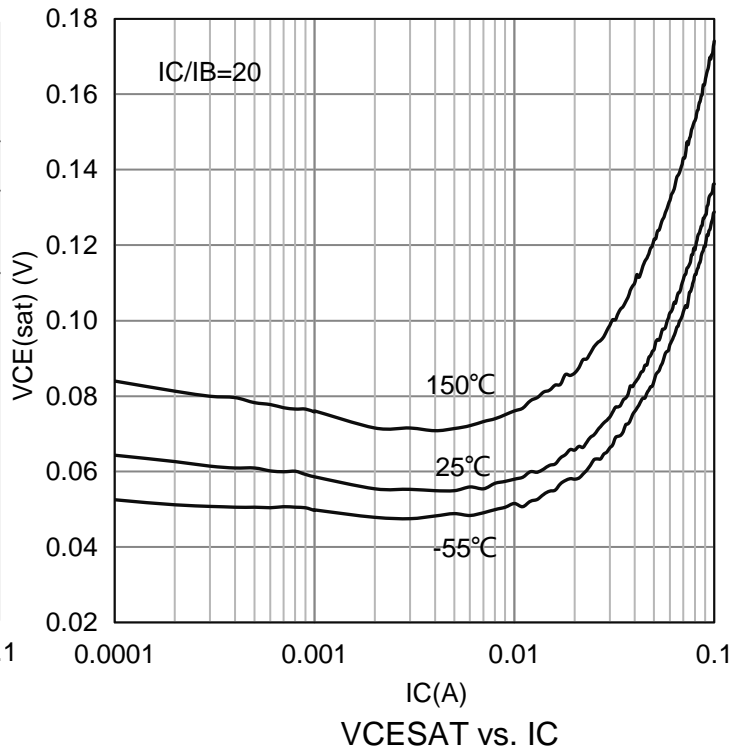
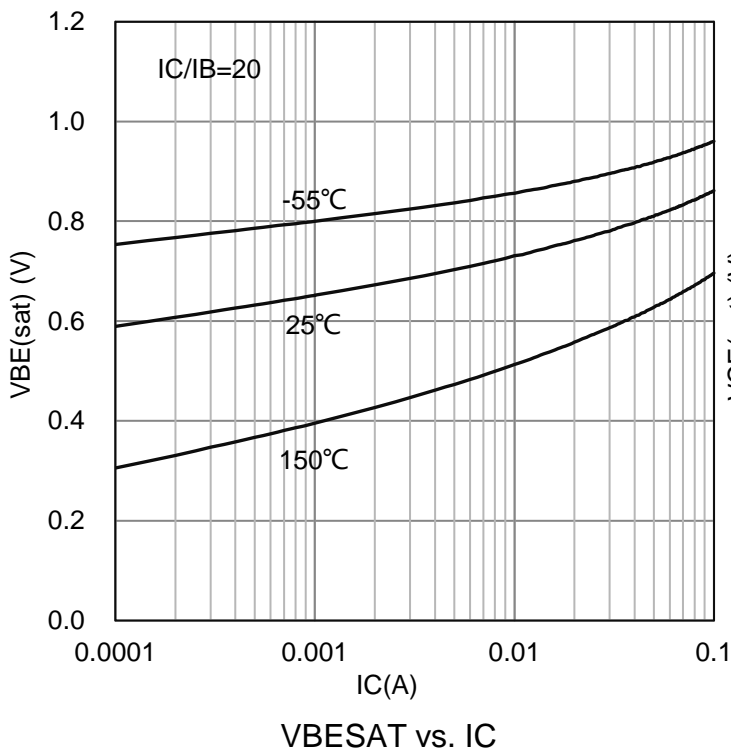
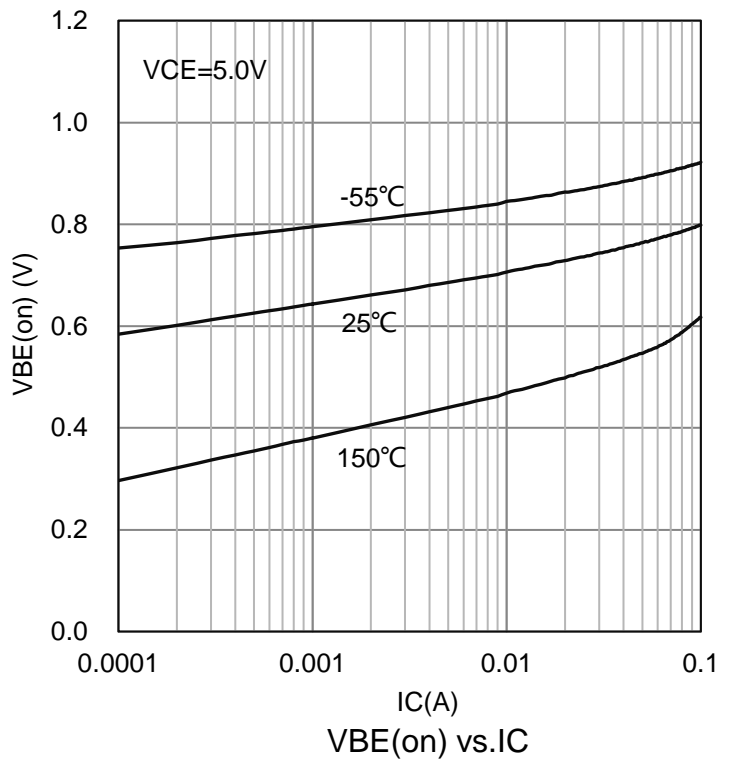
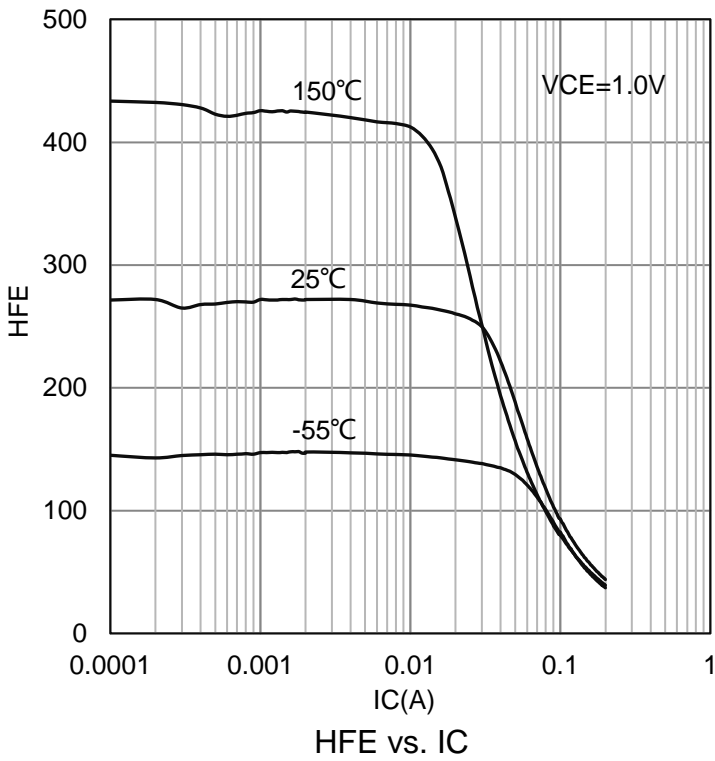

6.ELECTRICAL CHARACTERISTICS CURVES(Con.)

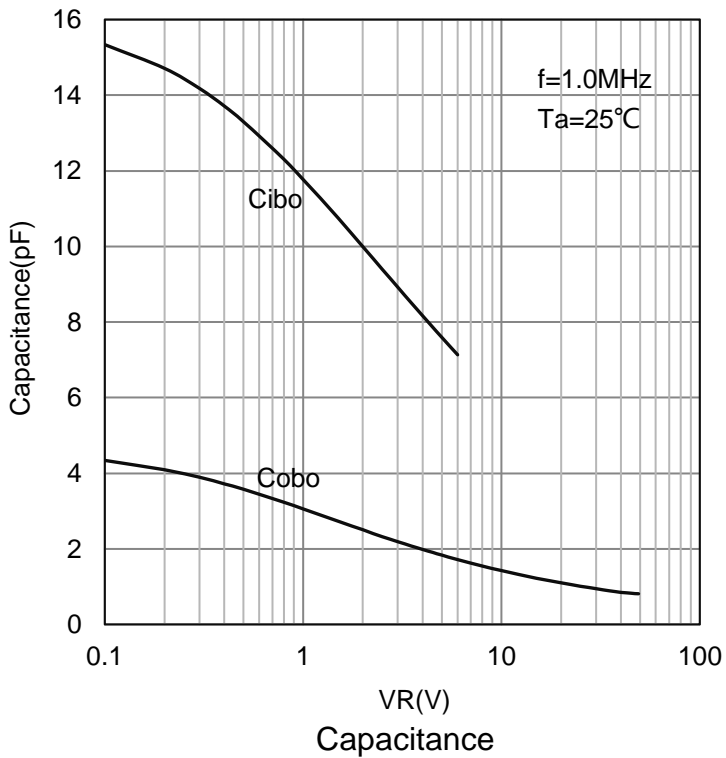
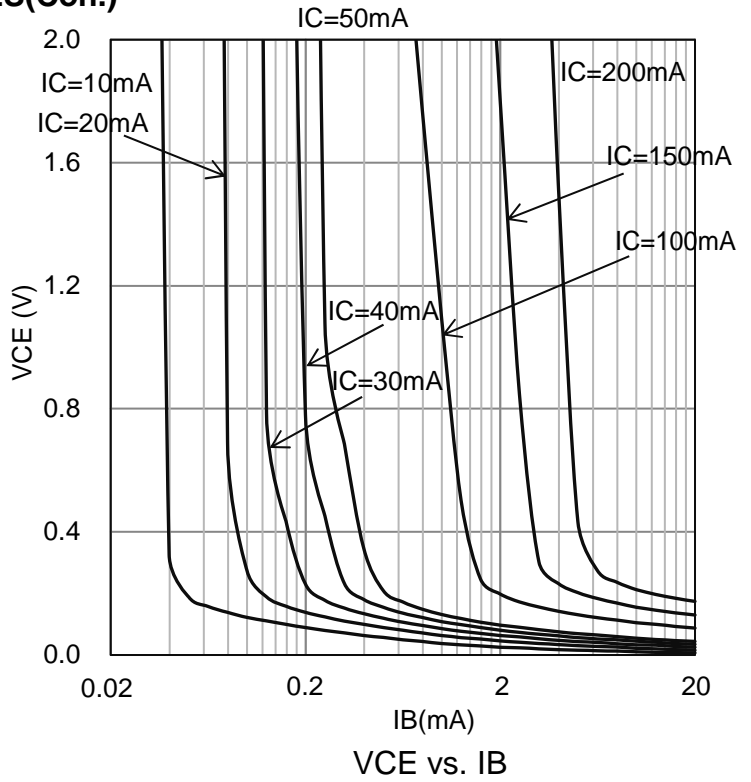
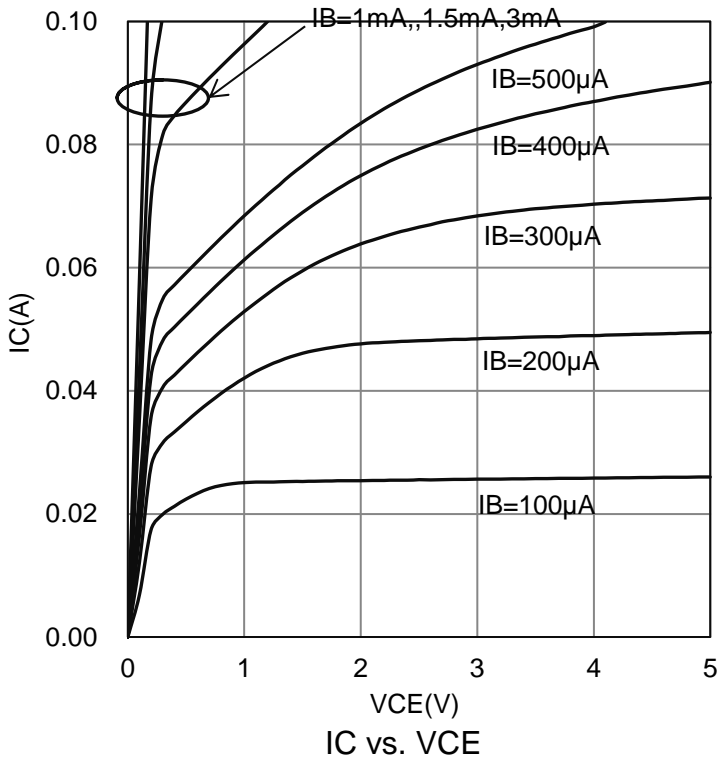

7. OUTLINE AND DIMENSIONS

Notes:

1. DIMENSIONING AND TOLERANCING PER ANSI Y14.5M, 1982.
2. CONTROLLING DIMENSION: MILLIMETERS.
3. MAXIMUM LEAD THICKNESS INCLUDES LEAD FINISH. MINIMUM LEAD THICKNESS IS THE MINIMUM THICKNESS OF BASE MATERIAL.
4. DIMENSIONS D AND E DO NOT INCLUDE MOLD FLASH, PROTRUSIONS OR GATE BURRS.

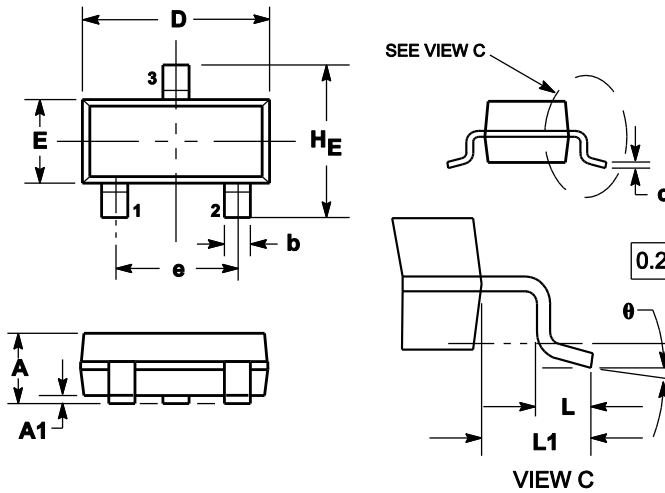

DIM	MILLIMETERS			INCHES		
	MIN	NOM	MAX	MIN	NOM	MAX
A	0.89	1	1.11	0.035	0.04	0.044
A1	0.01	0.06	0.1	0.001	0.002	0.004
b	0.37	0.44	0.5	0.015	0.018	0.02
c	0.09	0.13	0.18	0.003	0.005	0.007
D	2.80	2.9	3.04	0.11	0.114	0.12
E	1.20	1.3	1.4	0.047	0.051	0.055
e	1.78	1.9	2.04	0.07	0.075	0.081
L	0.10	0.2	0.3	0.004	0.008	0.012
L1	0.35	0.54	0.69	0.014	0.021	0.029
HE	2.10	2.4	2.64	0.083	0.094	0.104
θ	0°	---	10°	0°	---	10°

8. SOLDERING FOOTPRINT

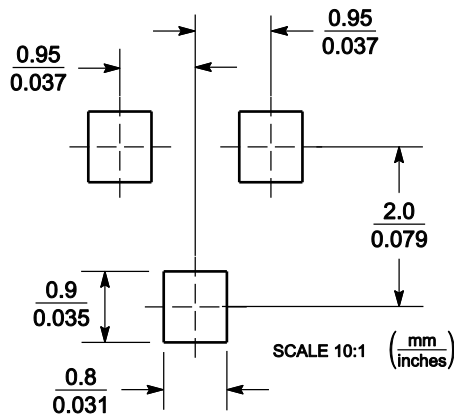

单击下面可查看定价，库存，交付和生命周期等信息

[>>LRC\(乐山无线电\)](#)