

LMBZ27VCLT1G

S-LMBZ27VCLT1G

Dual Common Cathode Zeners for ESD Protection

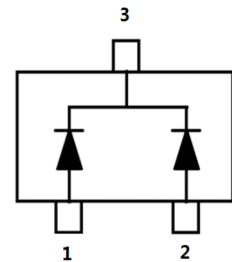
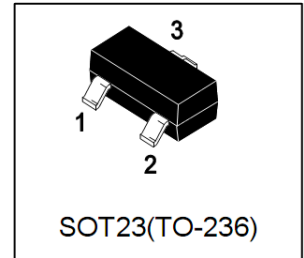

1. FEATURES

- Working Peak Reverse Voltage Range – 3 V to 26 V.
- Standard Zener Breakdown Voltage Range – 5.6 V to 33 V.
- Peak Power – 24 or 40 Watts @ 1.0 ms (Unidirectional), per Figure 5 Waveform.
- ESD Rating of Class N (exceeding 16 kV) per the Human Body Model.
- Low Leakage < 5.0 μ A.
- Flammability Rating UL 94 V-O
- Complies with IEC 61000-4-2 standards: Air discharge: \pm 30kV
Contact discharge: \pm 30kV
- We declare that the material of product compliance with RoHS requirements and Halogen Free.
- S- prefix for automotive and other applications requiring unique site and control change requirements; AEC-Q101 qualified and PPAP capable.

2. DEVICE MARKING AND ORDERING INFORMATION

Device	Marking	Shipping
LMBZ27VCLT1G	7VC	3000/Tape&Reel
LMBZ27VCLT3G	7VC	10000/Tape&Reel

3. MAXIMUM RATINGS(Ta = 25°C)

Parameter	Symbol	Limits	Unit
Peak Power Dissipation @ 1.0 ms (Note 1)	Ppk	40	W
Total Power Dissipation on FR-5 Board (Note 2) @TA = 25°C	PD	225	mW
Derate above 25°C		1.8	mW/°C
Thermal Resistance Junction-to-Ambient	R θ JA	556	°C/W
Total Power Dissipation on Alumina Substrate (Note 3) @TA = 25°C	PD	300	mW
Derate above 25°C		2.4	mW/°C
Thermal Resistance Junction-to-Ambient	R θ JA	417	°C/W
Junction and Storage Temperature Range	TJ, Tstg	-55~+150	°C
Lead Solder Temperature – Maximum (10 Second Duration)	TL	260	°C

1. Non-repetitive current pulse and derate above TA = 25°C .
2. FR-5 = 1.0 x 0.75 x 0.62 in.
3. Alumina = 0.4 x 0.3 x 0.024 in, 99.5% alumina.

4. ELECTRICAL CHARACTERISTICS (Ta= 25°C)

Symbol	Parameter
IPP	Maximum Reverse Peak Pulse Current
VC	Clamping Voltage @IPP
VRWM	Working Peak Reverse Voltage
IR	Maximum Reverse Leakage Current @VRWM
VBR	Breakdown Voltage @IT
IT	Test Current
θVBR	Maximum Temperature Coefficient of VBR
IF	Forward Current
VF	Forward Voltage @IF
ZZT	Maximum Zener Impedance @IZT
IZK	Reverse Current
ZZK	Maximum Zener Impedance @IZK

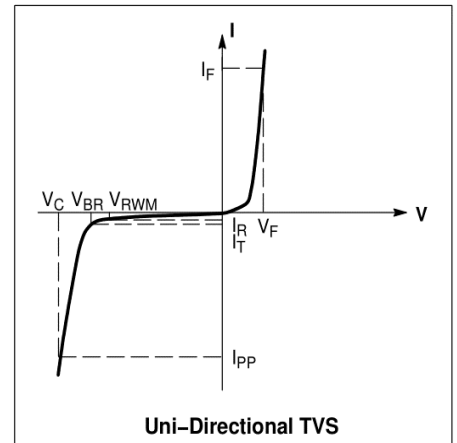

5. ELECTRICAL CHARACTERISTICS (Ta= 25°C)(VF ≤ 0.9V @ IF = 10 mA)

Characteristic	Symbol	Min.	Typ.	Max.	Unit
Breakdown Voltage (IT = 1mA)	VBR	25.65	27	28.35	V
Maximum Reverse Leakage Current (VRWM =22V)	IR	-	-	50	nA
Clamping Voltage (IPP=1A)	VC	-	-	40	V
Junction Capacitance (f=1MHz, Level=50mV, VR=0V)	Cj	-	-	60	pF
Maximum Temperature Coefficient of VBR	θVBR	-	-	24.3	mV/°C

6. ELECTRICAL CHARACTERISTICS CURVES

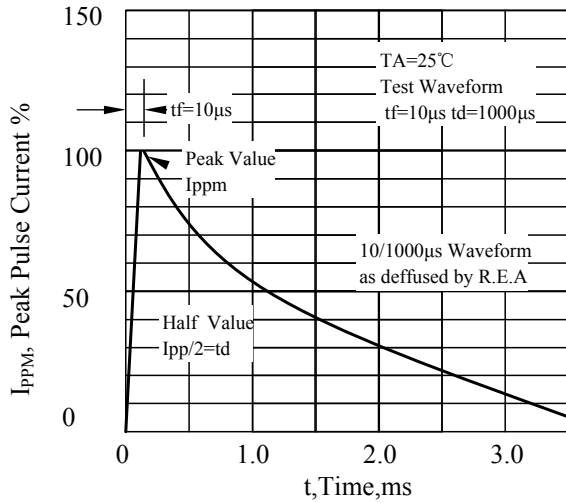

Pulse Waveform

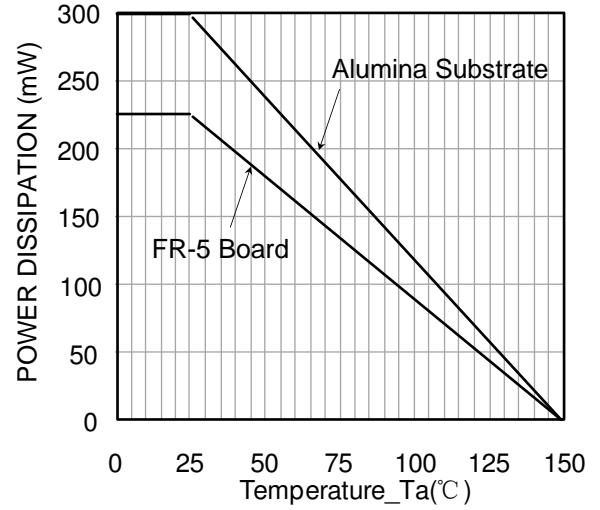

Steady State Power Derating Curve

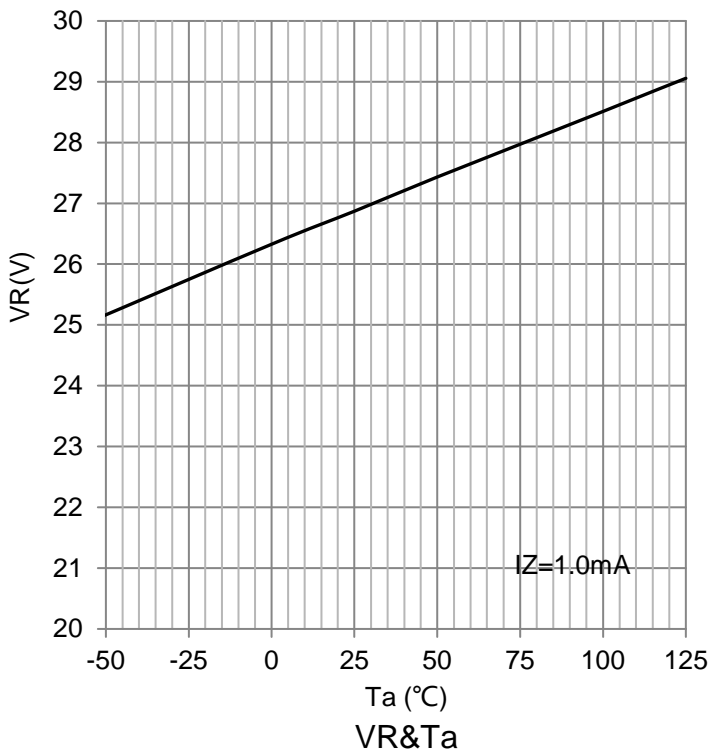

VR&Ta

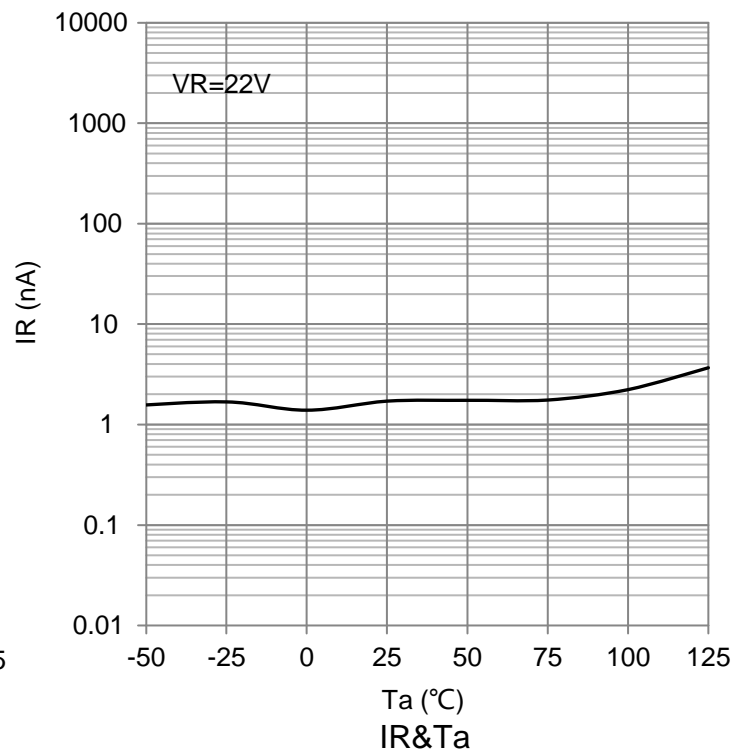

IR&Ta

6. ELECTRICAL CHARACTERISTICS CURVES(Con.)

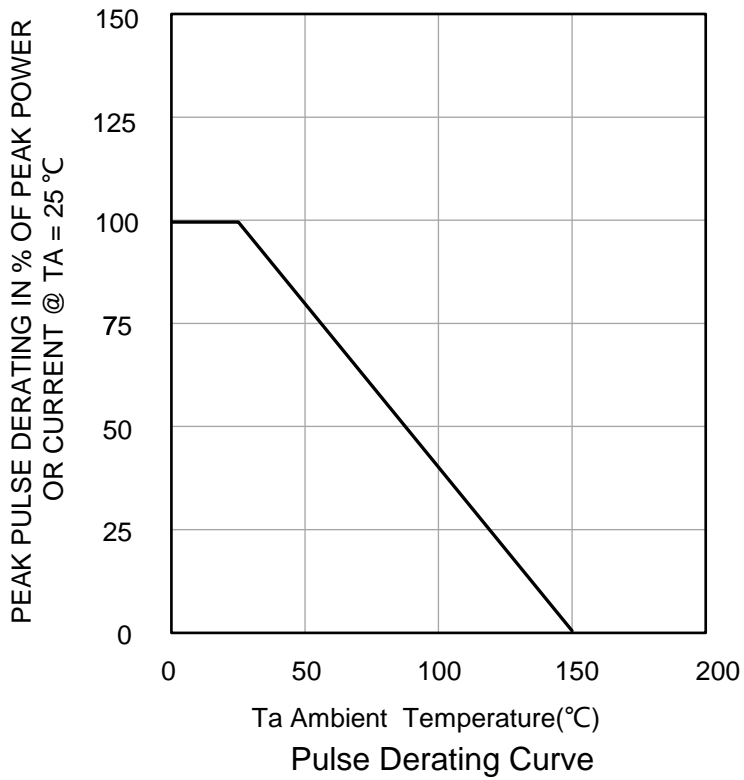

7. OUTLINE AND DIMENSIONS

Notes:

1. DIMENSIONING AND TOLERANCING PER ANSI Y14.5M, 1982.
2. CONTROLLING DIMENSION: MILLIMETERS.
3. MAXIMUM LEAD THICKNESS INCLUDES LEAD FINISH. MINIMUM LEAD THICKNESS IS THE MINIMUM THICKNESS OF BASE MATERIAL.
4. DIMENSIONS D AND E DO NOT INCLUDE MOLD FLASH, PROTRUSIONS OR GATE BURRS.

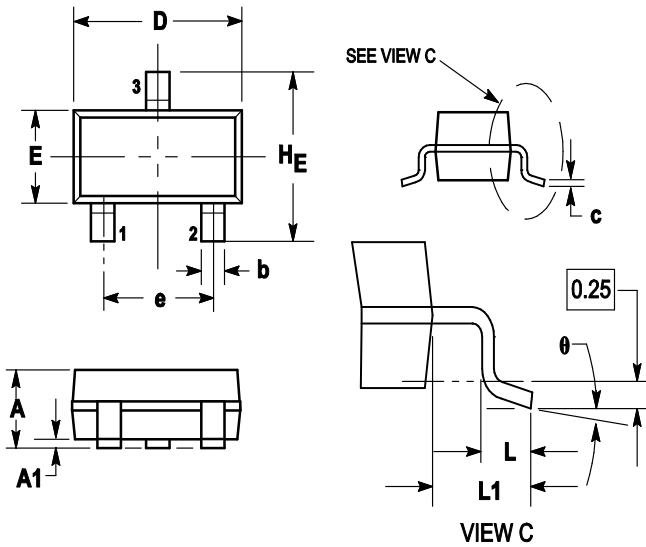

DIM	MILLIMETERS			INCHES		
	MIN	NOM	MAX	MIN	NOM	MAX
A	0.89	1	1.11	0.035	0.04	0.044
A1	0.01	0.06	0.1	0.001	0.002	0.004
b	0.37	0.44	0.5	0.015	0.018	0.02
c	0.09	0.13	0.18	0.003	0.005	0.007
D	2.80	2.9	3.04	0.11	0.114	0.12
E	1.20	1.3	1.4	0.047	0.051	0.055
e	1.78	1.9	2.04	0.07	0.075	0.081
L	0.10	0.2	0.3	0.004	0.008	0.012
L1	0.35	0.54	0.69	0.014	0.021	0.029
HE	2.10	2.4	2.64	0.083	0.094	0.104
θ	0°	---	10°	0°	---	10°

8. SOLDERING FOOTPRINT

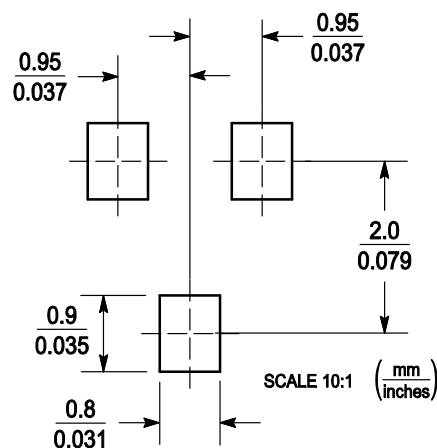

DISCLAIMER

- Curve guarantee in the specification. The curve of test items with electric parameter is used as quality guarantee. The curve of test items without electric parameter is used as reference only.
- Before you use our Products for new Project, you are requested to carefully read this document and fully understand its contents. LRC shall not be in any way responsible or liable for failure, malfunction or accident arising from the use of any LRC's Products against warning, caution or note contained in this document.
- All information contained in this document is current as of the issuing date and subject to change without any prior notice. Before purchasing or using LRC's Products, please confirm the latest information with a LRC sales representative.

单击下面可查看定价，库存，交付和生命周期等信息

[>>LRC\(乐山无线电\)](#)