

# LR2105LT1G

## S-LR2105LT1G

### ESD Protection Diode

#### 1. FEATURES

- Ultra low leakage: nA level.
- Low clamping voltage.
- Complies with IEC 61000-4-2 standards: Air discharge:  $\pm 30\text{kV}$   
Contact discharge:  $\pm 30\text{kV}$
- We declare that the material of product compliance with RoHS requirements and Halogen Free.
- S- Prefix for Automotive and Other Applications Requiring Unique Site and Control Change Requirements; AEC-Q101 Qualified and PPAP Capable.

#### 2. APPLICATIONS

- CAN bus protection
- Automotive applications

#### 3. DEVICE MARKING AND ORDERING INFORMATION

Device	Marking	Shipping
LR2105LT1G	R21	3000/Tape&Reel

#### 4. MAXIMUM RATINGS( $T_a = 25^\circ\text{C}$ )

Parameter	Symbol	Limits	Unit
IEC 61000-4-2 (ESD) Contact		$\pm 30$	kV
Air		$\pm 30$	
peak pulse power @ 8/20 $\mu\text{s}$	PPP	350	W
peak pulse current @ 8/20 $\mu\text{s}$	IPP	8	A
Storage Temperature Range	Tstg	$-55 \sim +150$	$^\circ\text{C}$
Operating Temperature Range	TJ	$-55 \sim +150$	$^\circ\text{C}$

#### 5. ELECTRICAL CHARACTERISTICS ( $T_a = 25^\circ\text{C}$ )

Symbol	Parameter
IPP	Maximum Reverse Peak Pulse Current
VC	Clamping Voltage @ IPP
VRWM	Working Peak Reverse Voltage
IR	Maximum Reverse Leakage Current @ VRWM
VBR	Breakdown Voltage @ IT
IT	Test Current
IF	Forward Current
VF	Forward Voltage @ IF
Ppk	Peak Power Dissipation
C	Capacitance @ VR = 0 and f = 1.0 MHz

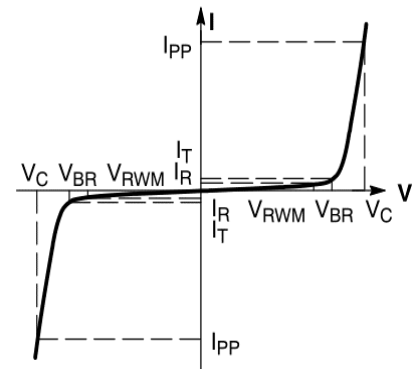
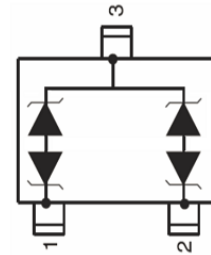
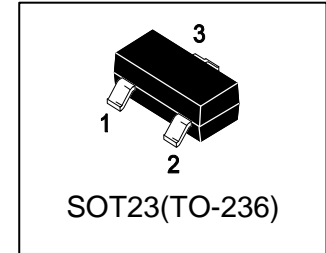

**6. ELECTRICAL CHARACTERISTICS (Ta= 25°C)**

Characteristic	Symbol	Min.	Typ.	Max.	Unit
reverse stand-off voltage	VRWM	-	-	24	V
reverse leakage current (VRWM = 24 V, Pin 1、 2to Pin 3) (VRWM = 24 V, Pin 3 to Pin 1、 2)	IRM	- -	- -	200 200	nA
breakdown voltage (IT = 5 mA, Pin 1、 2to Pin 3 ) (IT = 5 mA, Pin 3 to Pin 1、 2 )	VBR	26.2	-	32	V
Clamping Voltage (IPP = 3A (8 x 20µs pulse) (IPP = 5A (8 x 20µs pulse) (IPP = 8A (8 x 20µs pulse)	VC	- - -	32 34 37	34 36 39	V
Junction Capacitance (VR = 0V, f = 1MHz)	CJ	-	-	30	pF

### 7.ELECTRICAL CHARACTERISTICS CURVES

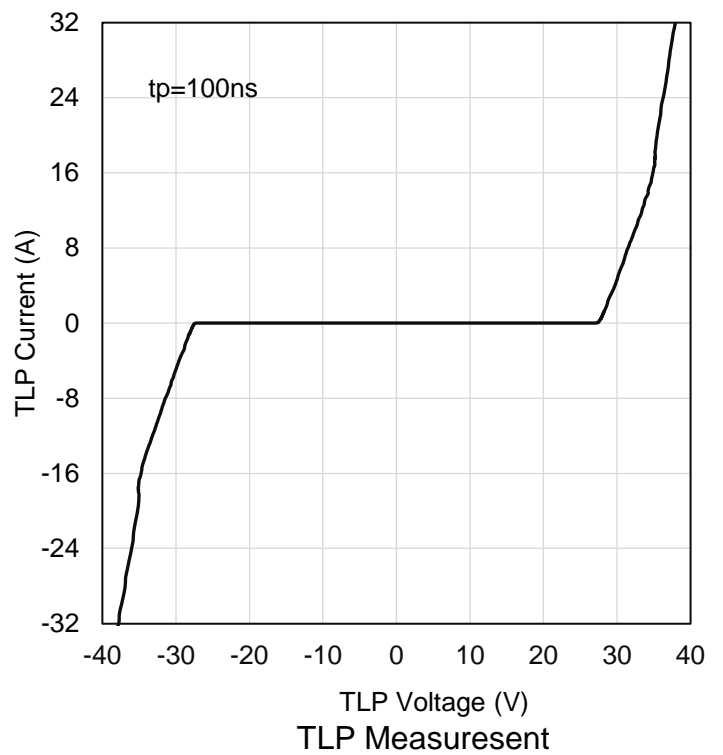
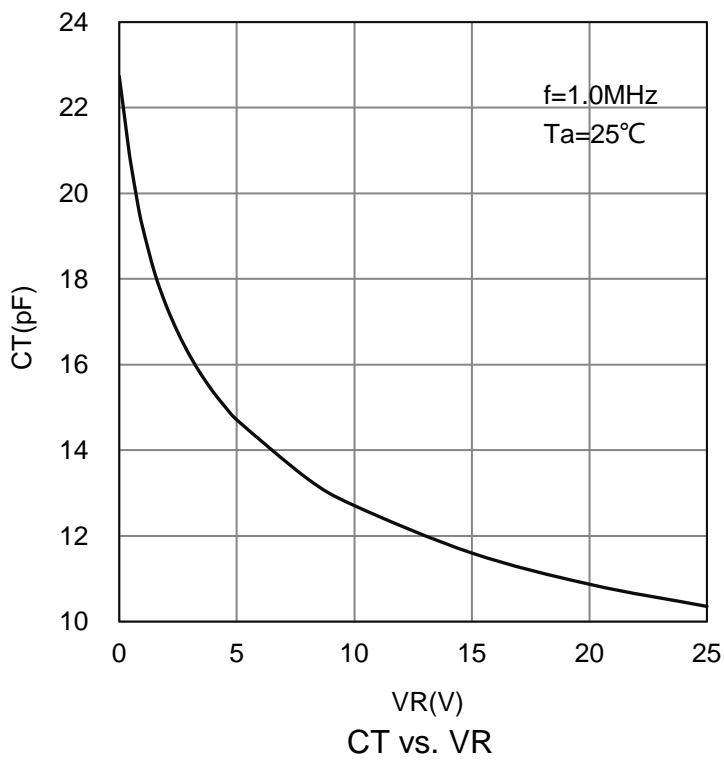
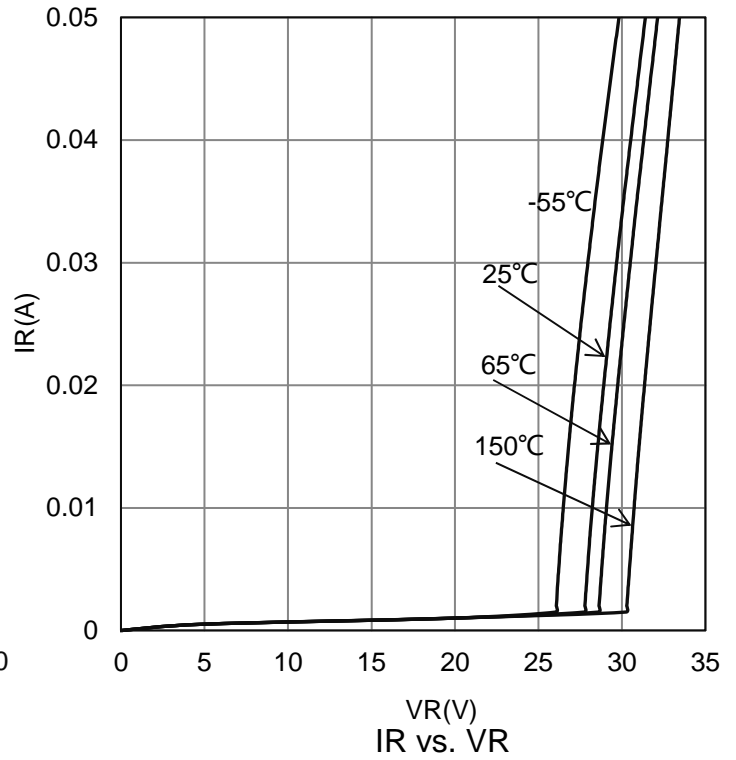
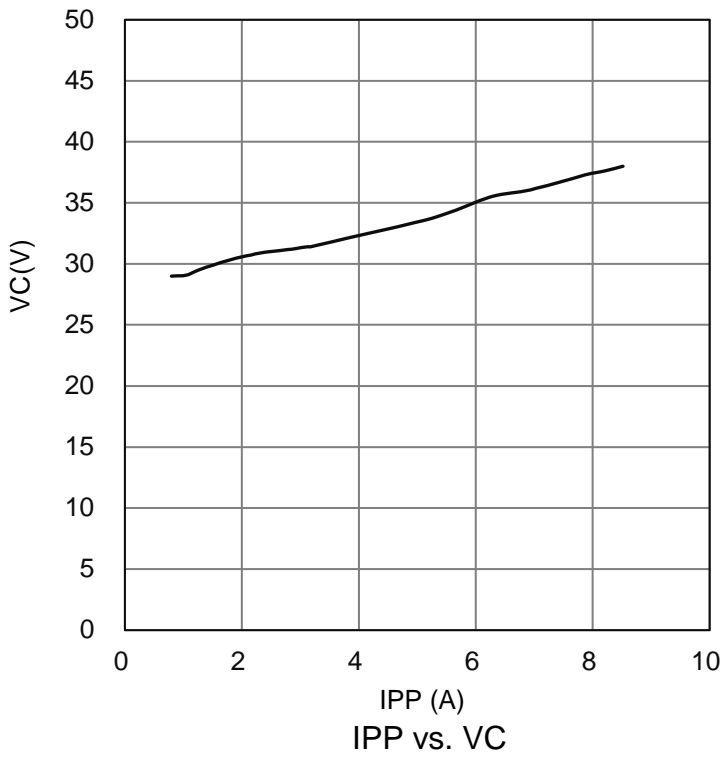

### 8.OUTLINE AND DIMENSIONS

Notes:

1. DIMENSIONING AND TOLERANCING PER ANSI Y14.5M, 1982.
2. CONTROLLING DIMENSION: MILLIMETERS.
3. MAXIMUM LEAD THICKNESS INCLUDES LEAD FINISH. MINIMUM LEAD THICKNESS IS THE MINIMUM THICKNESS OF BASE MATERIAL.
4. DIMENSIONS D AND E DO NOT INCLUDE MOLD FLASH, PROTRUSIONS OR GATE BURRS.

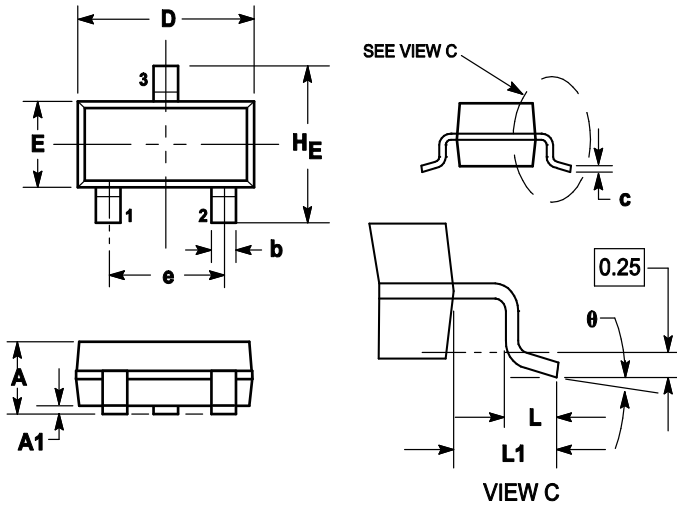

DIM	MILLIMETERS			INCHES		
	MIN	NOM	MAX	MIN	NOM	MAX
A	0.89	1	1.11	0.035	0.04	0.044
A1	0.01	0.06	0.1	0.001	0.002	0.004
b	0.37	0.44	0.5	0.015	0.018	0.02
c	0.09	0.13	0.18	0.003	0.005	0.007
D	2.80	2.9	3.04	0.11	0.114	0.12
E	1.20	1.3	1.4	0.047	0.051	0.055
e	1.78	1.9	2.04	0.07	0.075	0.081
L	0.10	0.2	0.3	0.004	0.008	0.012
L1	0.35	0.54	0.69	0.014	0.021	0.029
HE	2.10	2.4	2.64	0.083	0.094	0.104
θ	0°	---	10°	0°	---	10°

### 9.SOLDERING FOOTPRINT

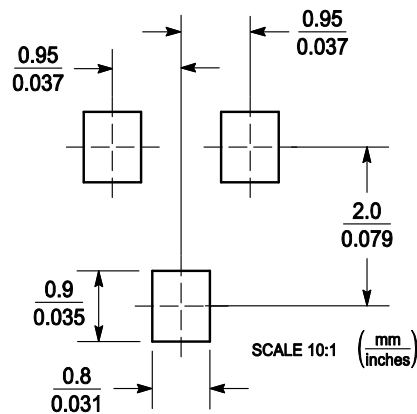

单击下面可查看定价，库存，交付和生命周期等信息

[>>LRC\(乐山无线电\)](#)