

S-SM3100A

Schottky Barrier Rectifiers

Reverse Voltage 100V Forward Current 3.0A

FEATURES

- * Plastic package has Underwriters Laboratory Flammability Classification 94V-0
- * Low power loss,high efficiency
- * For use in low voltage high frequency inverters, free wheeling,and polarity protection applications
- * Guardring for over voltage protection
- * High temperature soldering guaranteed: 260°C/10 seconds at terminals
- * S- Prefix for Automotive and Other Applications Requiring Unique Site and Control Change Requirements; AEC-Q101 Qualified and PPAP Capable.

Mechanical Data

Case: JEDEC DO-214AC,
molded plastic

Terminals: Plated axial leads, solderable per
MIL-STD-750, Method 2026

Polarity: Color band denotes cathode end

Mounting Position: Any

Weight: 0.0023 oz., 0.065 g

Handling precaution:None

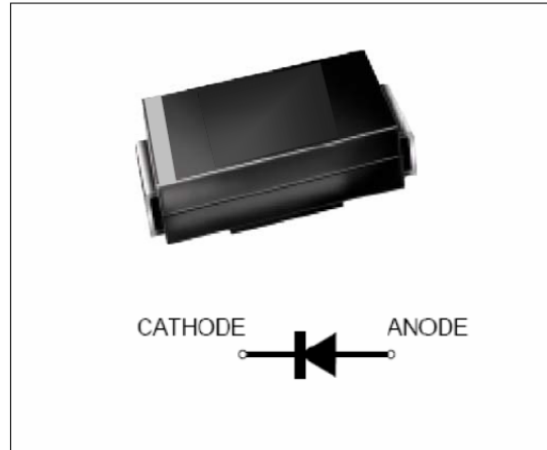

We declare that the material of product is
Halogen free (green epoxy compound)

1.Electrical Characteristic

Maximum & Thermal Characteristics Ratings at 25°C ambient temperature unless otherwise specified.

Parameter Symbol	symbol	S-SM3100A	Unit
device marking code		S310	
Maximum repetitive peak reverse voltage	V_{RRM}	100	V
Maximum RMS voltage	V_{RMS}	70	V
Maximum DC blocking voltage	V_{DC}	100	V
Maximum average forward rectified current at TC= 75°C	$I_{F(AV)}$	3.0	A
Peak forward surge current 8.3ms single half sine-wave superimposed on rated load (JEDEC Method)	I_{FSM}	90	A
Typical thermal resistance (Note 1)	$R_{\theta JA}$	150	°C/W
Operating junction and storage temperature range	T_J, T_{STG}	-40 to +150	°C

Electrical Characteristics Ratings at 25°C ambient temperature unless otherwise specified.

Parameter Symbol	symbol	S-SM3100A	Unit
Maximum instantaneous forward voltage at 3.0A	V_F	0.87	V
Maximum DC reverse current $T_A = 25^\circ\text{C}$ at rated DC blocking voltage $T_J = 100^\circ\text{C}$	I_R	0.1 10.0	mA
Typical junction capacitance at 4.0V, 1MHz	C_J	160	PF

NOTES:

1. 8.0mm² (.013mm thick) land areas

S-SM3100A

2. Ratings and Characteristic Curves (TA = 25°C unless otherwise noted)

Fig. 1 - Forward Current Derating Curve

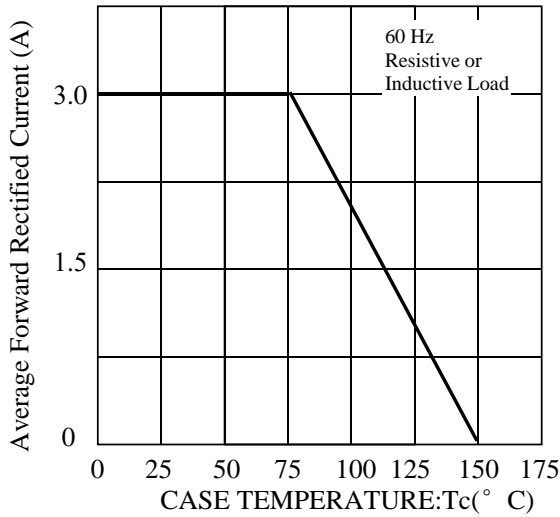

Fig. 2 - Maximum Non-repetitive Peak Forward Surge Current

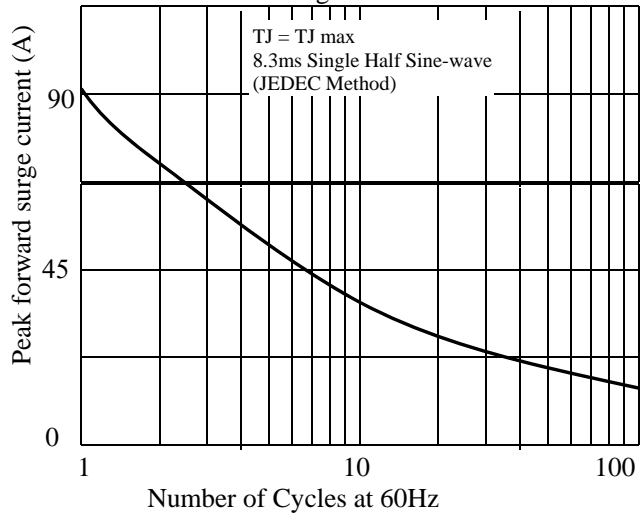

Fig 3. - Typical Instantaneous Forward Characteristics

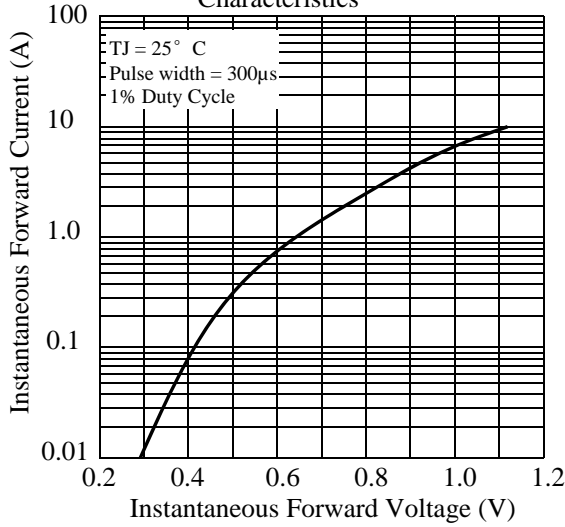

Fig 4. - Typical Reverse Characteristics

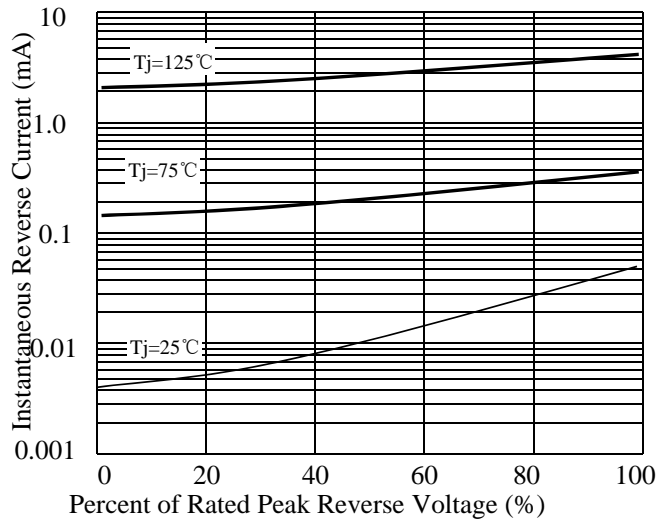

Fig 5. - typical transient thermal impedance

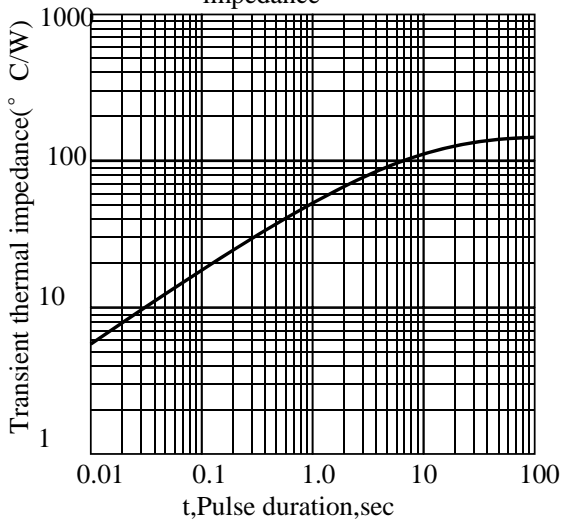
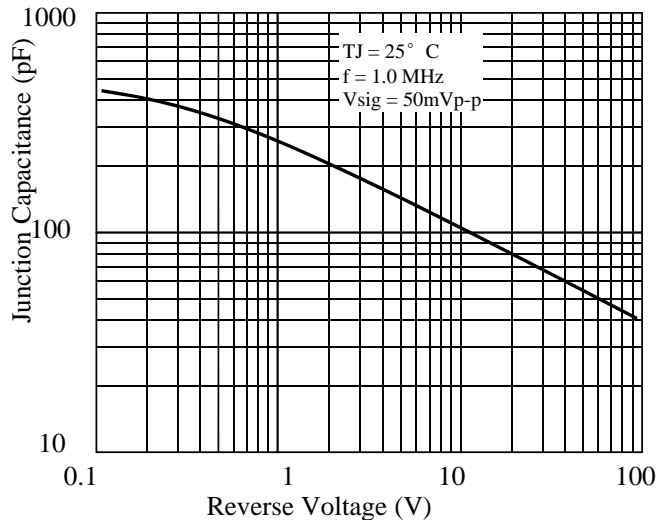
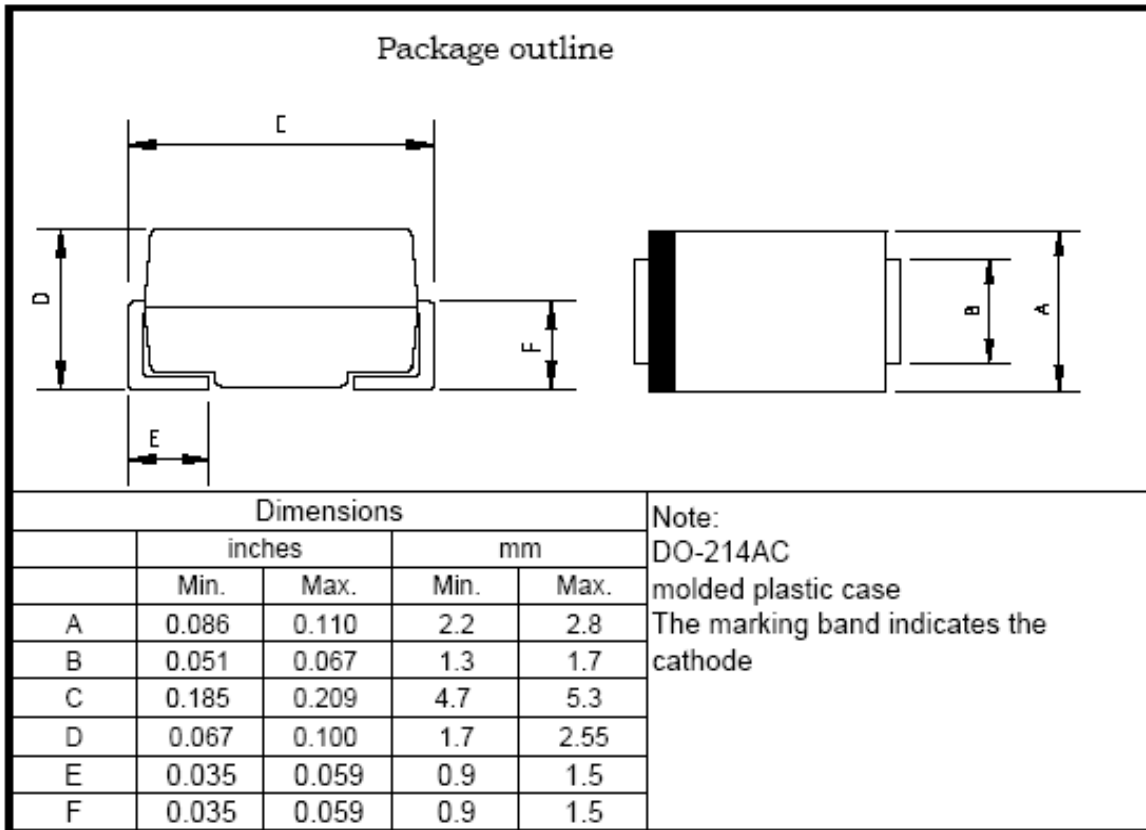

Fig 6. - Typical Junction Capacitance



S-SM3100A

3. dimension:



S-SM3100A

4. Update Record

版次	更新记录	更新作者	更新日期
1	第一版	谭志伟	2021-4-07

单击下面可查看定价，库存，交付和生命周期等信息

[>>LRC\(乐山无线电\)](#)