

General Purpose Transistors

NPN Silicon

FEATURE

- Simplifies Circuit Design.
- We declare that the material of product compliance with RoHS requirements.
- S- Prefix for Automotive and Other Applications Requiring Unique Site and Control Change Requirements; AEC-Q101 Qualified and PPAP Capable.

LMBT3904TT1G
S-LMBT3904TT1G

ORDERING INFORMATION

Device	Marking	Shipping
LMBT3904TT1G	MA	3000/Tape&Reel
S-LMBT3904TT1G	MA	3000/Tape&Reel
LMBT3904TT3G	MA	10000/Tape&Reel
S-LMBT3904TT3G	MA	10000/Tape&Reel

MAXIMUM RATINGS

Rating	Symbol	Value	Unit
Collector–Emitter Voltage	V_{CEO}	40	Vdc
Collector–Base Voltage	V_{CBO}	60	Vdc
Emitter–Base Voltage	V_{EBO}	6.0	Vdc
Collector Current — Continuous	I_C	200	mAdc

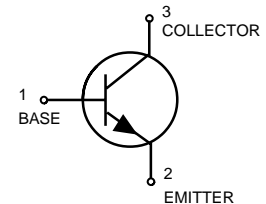
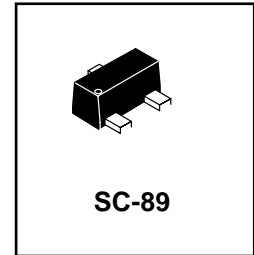

THERMAL CHARACTERISTICS

Characteristic	Symbol	Max	Unit
Total Device Dissipation FR– 4 Board, (1) $T_A = 25^\circ\text{C}$	P_D	200	mW
Derate above 25°C		1.6	mW/ $^\circ\text{C}$
Thermal Resistance, Junction to Ambient	$R_{\theta JA}$	600	$^\circ\text{C}/\text{W}$
Total Device Dissipation FR-4 Board(2), $T_A = 25^\circ\text{C}$	P_D	300	mW
Derate above 25°C		2.4	mW/ $^\circ\text{C}$
Thermal Resistance, Junction to Ambient	$R_{\theta JA}$	400	$^\circ\text{C}/\text{W}$
Junction and Storage Temperature	T_J, T_{sig}	-55 to +150	$^\circ\text{C}$

DEVICE MARKING

LMBT3904TT1G = MA

ELECTRICAL CHARACTERISTICS ($T_A = 25^\circ\text{C}$ unless otherwise noted.)

Characteristic	Symbol	Min	Max	Unit
----------------	--------	-----	-----	------

OFF CHARACTERISTICS

Collector–Emitter Breakdown Voltage(3) ($I_C = 1.0 \text{ mAdc}$)	$V_{(BR)CEO}$	40	—	Vdc
Collector–Base Breakdown Voltage ($I_C = 10 \mu\text{Adc}$)	$V_{(BR)CBO}$	60	—	Vdc
Emitter–Base Breakdown Voltage ($I_E = 10 \mu\text{Adc}$)	$V_{(BR)EBO}$	6.0	—	Vdc
Base Cutoff Current ($V_{CE} = 30 \text{ Vdc}, V_{EB} = 3.0 \text{ Vdc}$)	I_{BL}	—	50	nAdc
Collector Cutoff Current ($V_{CE} = 30 \text{ Vdc}, V_{EB} = 3.0 \text{ Vdc}$)	I_{CEX}	—	50	nAdc

1. FR-4 Minimum Pad.
2. FR-4 1.0 x 1.0 Inch Pad.
3. Pulse Test: Pulse Width $\leq 300 \mu\text{s}$, Duty Cycle $\leq 2.0\%$.

LMBT3904TT1G;S-LMBT3904TT1G
ELECTRICAL CHARACTERISTICS ($T_A = 25^\circ\text{C}$ unless otherwise noted) (Continued)

Characteristic	Symbol	Min	Max	Unit
DC CHARACTERISTICS (3)				
DC Current Gain(1) ($I_C = 0.1 \text{ mA}$, $V_{CE} = 1.0 \text{ Vdc}$)	h_{FE}	40	—	—
($I_C = 1.0 \text{ mA}$, $V_{CE} = 1.0 \text{ Vdc}$)		70	—	
($I_C = 10 \text{ mA}$, $V_{CE} = 1.0 \text{ Vdc}$)		100	300	
($I_C = 50 \text{ mA}$, $V_{CE} = 1.0 \text{ Vdc}$)		60	—	
($I_C = 100 \text{ mA}$, $V_{CE} = 1.0 \text{ Vdc}$)		30	—	
Collector–Emitter Saturation Voltage ($I_C = 10 \text{ mA}$, $I_B = 1.0 \text{ mA}$)(3)	$V_{CE(sat)}$	—	0.2	Vdc
($I_C = 50 \text{ mA}$, $I_B = 5.0 \text{ mA}$)		—	0.3	
Base–Emitter Saturation Voltage(3) ($I_C = 10 \text{ mA}$, $I_B = 1.0 \text{ mA}$)	$V_{BE(sat)}$	0.65	0.85	Vdc
($I_C = 50 \text{ mA}$, $I_B = 5.0 \text{ mA}$)		—	0.95	

SMALL–SIGNAL CHARACTERISTICS

Current–Gain — Bandwidth Product ($I_C = 10 \text{ mA}$, $V_{CE} = 20 \text{ Vdc}$, $f = 100 \text{ MHz}$)	f_T	200	—	MHz
Output Capacitance ($V_{CB} = 5.0 \text{ Vdc}$, $I_E = 0$, $f = 1.0 \text{ MHz}$)	C_{obo}	—	4.0	pF
Input Capacitance ($V_{BE} = 0.5 \text{ Vdc}$, $I_C = 0$, $f = 1.0 \text{ MHz}$)	C_{ibo}	—	8.0	pF
Input Impedance ($V_{CE} = 10 \text{ Vdc}$, $I_C = 1.0 \text{ mA}$, $f = 1.0 \text{ kHz}$)	h_{ie}	1.0	10	pF
Voltage Feedback Ratio ($V_{CE} = 10 \text{ Vdc}$, $I_C = 1.0 \text{ mA}$, $f = 1.0 \text{ kHz}$)	h_{re}	0.5	8.0	$\times 10^{-4}$
Small–Signal Current Gain ($V_{CE} = 10 \text{ Vdc}$, $I_C = 1.0 \text{ mA}$, $f = 1.0 \text{ kHz}$)	h_{fe}	100	400	—
Output Admittance ($V_{CE} = 10 \text{ Vdc}$, $I_C = 1.0 \text{ mA}$, $f = 1.0 \text{ kHz}$)	h_{oe}	1.0	40	mhos
Noise Figure ($V_{CE} = 5.0 \text{ Vdc}$, $I_C = 100 \mu\text{A}$, $R_s = 1.0 \text{ k}\Omega$, $f = 1.0 \text{ kHz}$)	NF	—	5.0	dB

SWITCHING CHARACTERISTICS

Delay Time ($V_{CC} = 3.0 \text{ Vdc}$, $V_{BE} = 0.5 \text{ Vdc}$)	t_d	—	35	ns
Rise Time ($I_C = 10 \text{ mA}$, $I_{B1} = 1.0 \text{ mA}$)	t_r	—	35	ns
Storage Time ($V_{CC} = 3.0 \text{ Vdc}$)	t_s	—	200	ns
Fall Time ($I_C = 10 \text{ mA}$, $I_{B1} = I_{B2} = 1.0 \text{ mA}$)	t_f	—	50	ns

 3. Pulse Test: Pulse Width $\leq 300 \mu\text{s}$, Duty Cycle $\leq 2.0\%$.

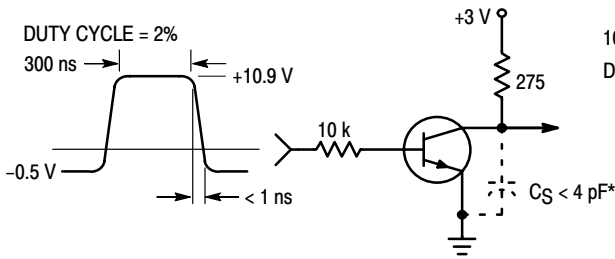

Figure 1. Delay and Rise Time Equivalent Test Circuit

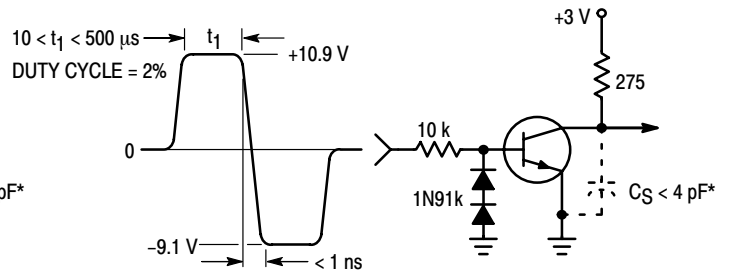

Figure 2. Storage and Fall Time Equivalent Test Circuit

* Total shunt capacitance of test jig and connectors

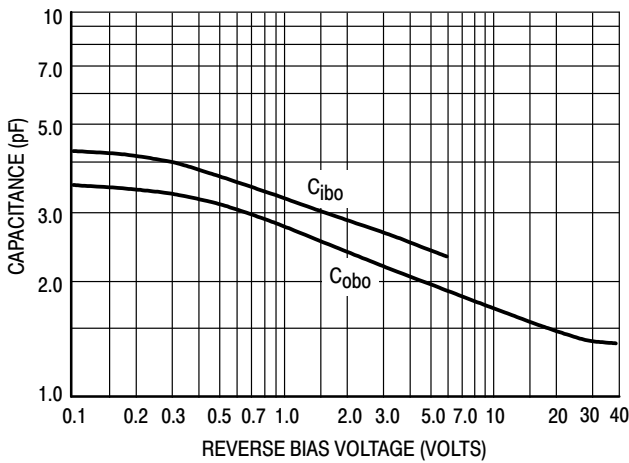

Figure 3. Capacitance

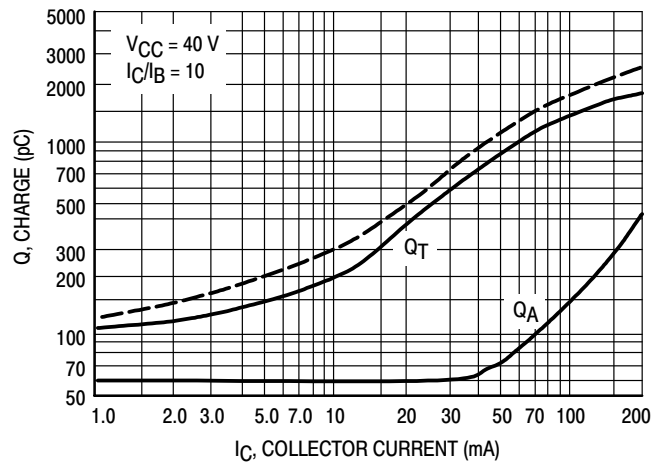

Figure 4. Charge Data

LMBT3904TT1G;S-LMBT3904TT1G

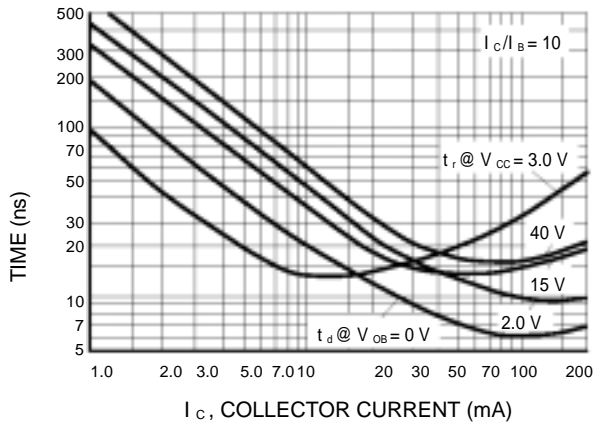

Figure 5. Turn-On Time

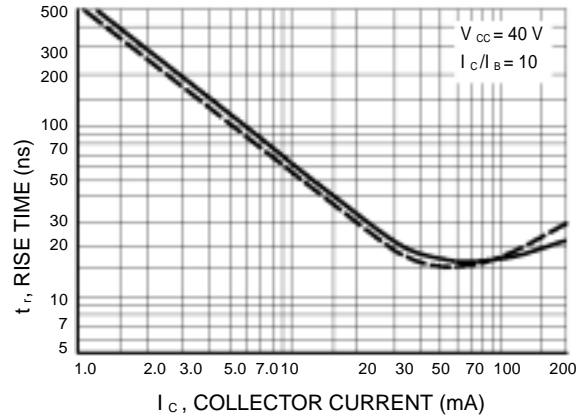

Figure 6. Rise Time

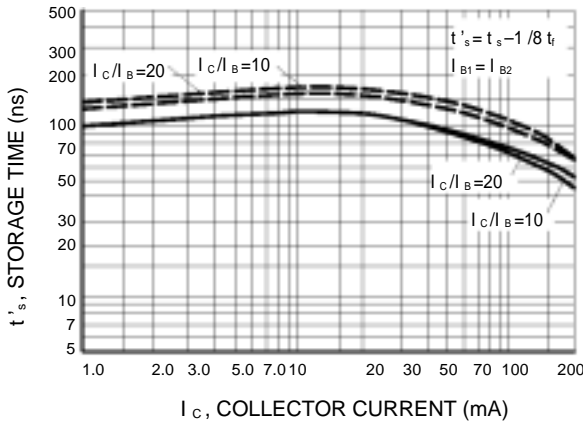

Figure 7. Storage Time

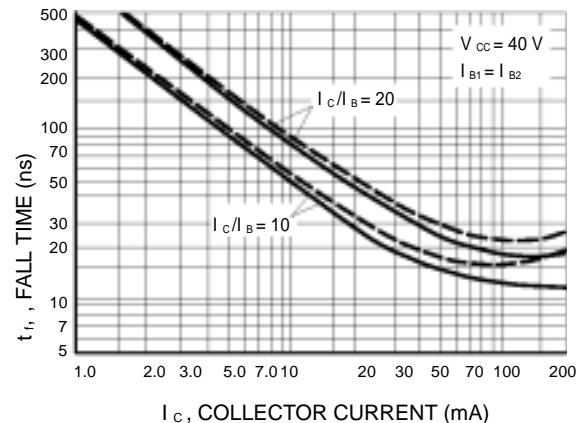

Figure 8. Fall Time

TYPICAL AUDIO SMALL-SIGNAL CHARACTERISTICS
NOISE FIGURE VARIATIONS

($V_{CE} = 5.0$ Vdc, $T_A = 25^\circ\text{C}$, Bandwidth = 1.0 Hz)

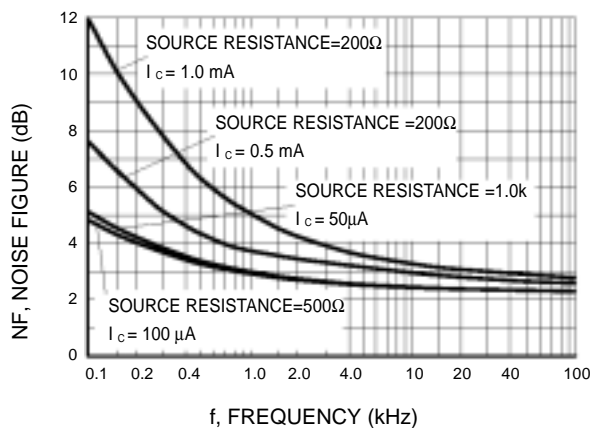

Figure 9.

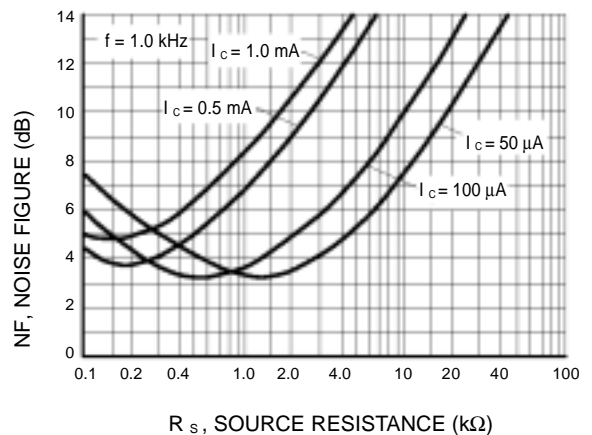
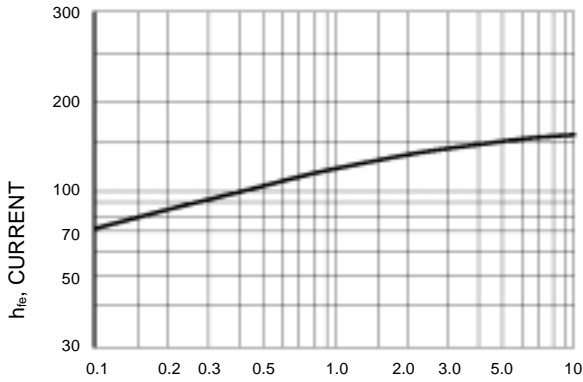

Figure 10.

h PARAMETERS

($V_{CE} = 10 \text{ Vdc}$, $f = 1.0 \text{ kHz}$, $T_A = 25^\circ\text{C}$)



I_C , COLLECTOR CURRENT (mA)

Figure 11. Current Gain

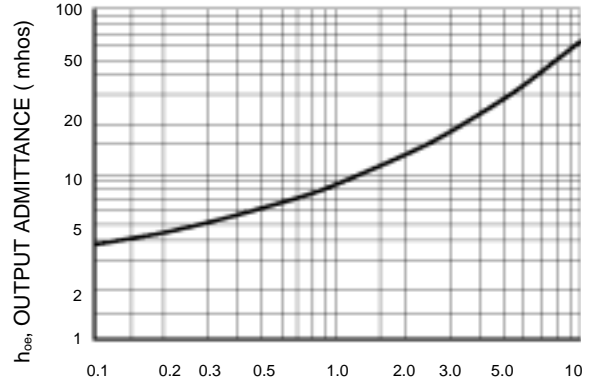

I_C , COLLECTOR CURRENT (mA)

Figure 12. Output Admittance

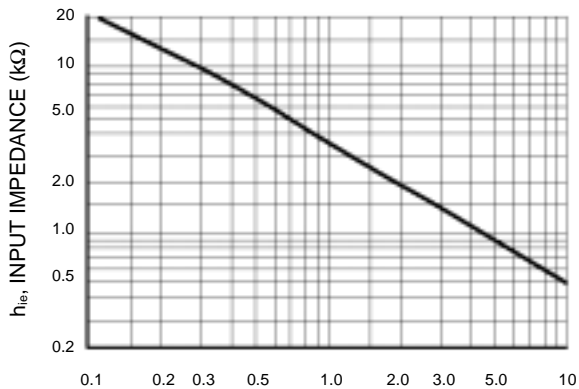

I_C , COLLECTOR CURRENT (mA)

Figure 13. Input Impedance

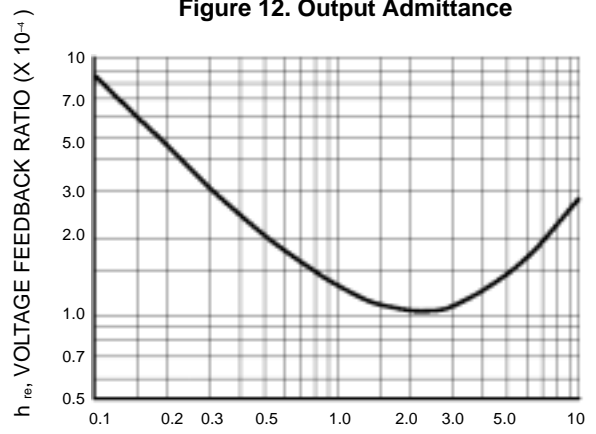

I_C , COLLECTOR CURRENT (mA)

Figure 14. Voltage Feedback Ratio

TYPICAL STATIC CHARACTERISTICS

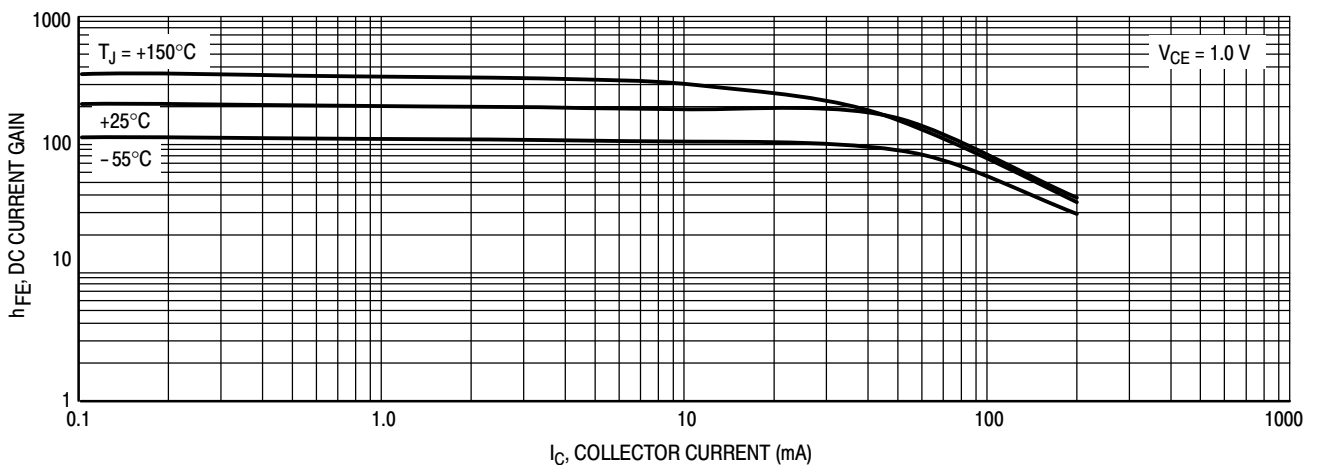

I_C , COLLECTOR CURRENT (mA)

Figure 15. DC Current Gain

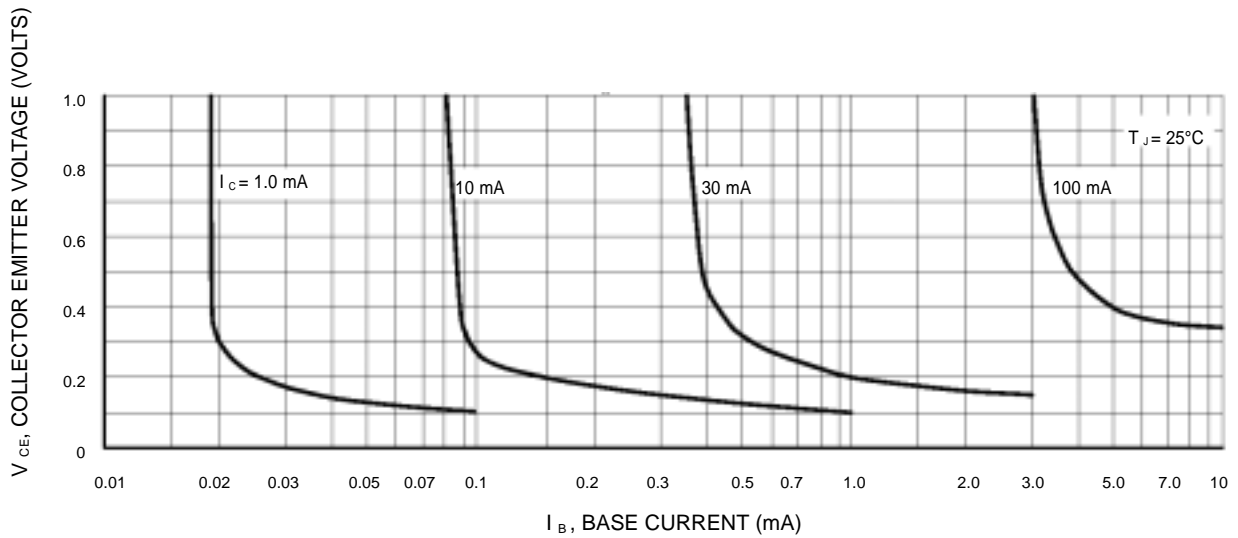

Figure 16. Collector Saturation Region

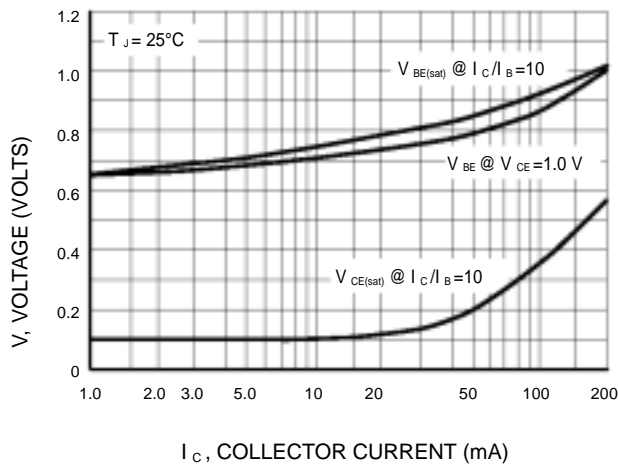

Figure 17. "ON" Voltages

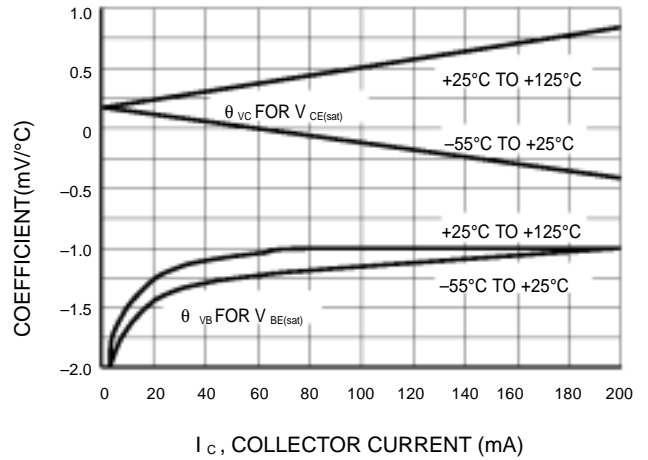
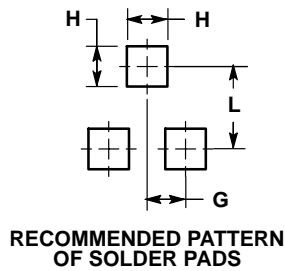
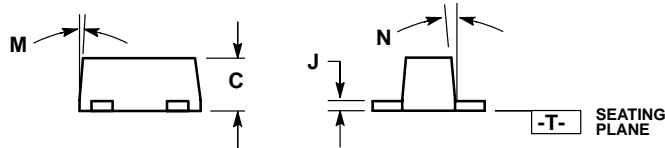
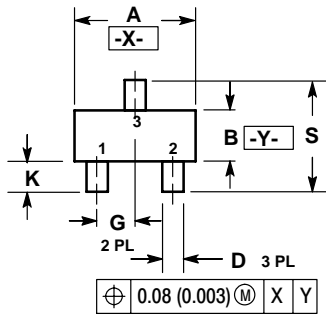

Figure 18. Temperature Coefficients

LMBT3904TT1G;S-LMBT3904TT1G

SC-89



NOTES:

1. DIMENSIONING AND TOLERANCING PER ANSI Y14.5M, 1982.
2. CONTROLLING DIMENSION: MILLIMETERS
3. MAXIMUM LEAD THICKNESS INCLUDES LEAD FINISH THICKNESS. MINIMUM LEAD THICKNESS IS THE MINIMUM THICKNESS OF BASE MATERIAL.
4. 463C-01 OBSOLETE, NEW STANDARD 463C-02.

DIM	MILLIMETERS			INCHES		
	MIN	NOM	MAX	MIN	NOM	MAX
A	1.50	1.60	1.70	0.059	0.063	0.067
B	0.75	0.85	0.95	0.030	0.034	0.040
C	0.60	0.70	0.80	0.024	0.028	0.031
D	0.23	0.28	0.33	0.009	0.011	0.013
G	0.50 BSC			0.020 BSC		
H	0.53 REF			0.021 REF		
J	0.10	0.15	0.20	0.004	0.006	0.008
K	0.30	0.40	0.50	0.012	0.016	0.020
L	1.10 REF			0.043 REF		
M	---	---	10 °	---	---	10 °
N	---	---	10 °	---	---	10 °
S	1.50	1.60	1.70	0.059	0.063	0.067

单击下面可查看定价，库存，交付和生命周期等信息

[>>LRC\(乐山无线电\)](#)