

# LBAV70LT1G

## S-LBAV70LT1G

Monolithic Dual Switching Diode  
Common Cathode

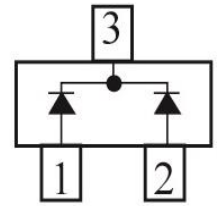
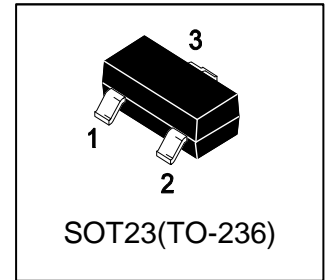

### 1. FEATURES

- We declare that the material of product compliance with RoHS requirements and Halogen Free.
- S-prefix for automotive and other applications requiring unique site and control change requirements; AEC-Q101 qualified and PPAP capable.

### 2. DEVICE MARKING AND ORDERING INFORMATION

Device	Marking	Shipping
LBAV70LT1G	A4	3000/Tape&Reel
LBAV70LT3G	A4	10000/Tape&Reel

### 3. MAXIMUM RATINGS(Ta = 25°C)

Parameter	Symbol	Limits	Unit
Reverse Voltage	VR	100	V
Forward Current	IF	200	mA
Repetitive Peak Forward Current	IFRM	500	mA
Non-Repetitive Peak Forward Current	IFSM	2	A
t=1μs		1	
t=1ms		0.5	
t=1s			

### 4. THERMAL CHARACTERISTICS

Parameter	Symbol	Limits	Unit
Total Device Dissipation, FR-5 Board (Note 1) @ TA = 25°C	PD	225	mW
Derate above 25°C		1.8	mW/°C
Thermal Resistance (Note 1)	RθJA RθJC	556 200	°C/W
Junction and Storage temperature	TJ, Tstg	-55 ~ +150	°C

1. FR-5 = 1.0×0.75×0.062 in.

**5. ELECTRICAL CHARACTERISTICS (Ta= 25°C)**

Characteristic	Symbol	Min.	Typ.	Max.	Unit
Reverse Breakdown Voltage (I(BR)=100μA)	VBR	100	-	-	V
Forward Voltage (IF = 1.0 mA)	VF	-	-	715	mV
(IF = 10 mA)		-	-	855	
(IF = 50 mA)		-	-	1000	
(IF = 150 mA)		-	-	1250	
Reverse Voltage Leakage Current (VR = 70V)	IR	-	-	2.5	μA
(VR = 100V)		-	-	2.6	
(VR = 70V, TJ = 150°C)		-	-	100	
(VR = 25V, TJ = 150°C)		-	-	60	
Diode Capacitance (VR = 0V, f = 1.0 MHz)	CD	-	-	1.5	pF
Reverse Recovery Time (IF=IR=10mA, IR(REC)=1.0 mA, RL =100Ω)	trr	-	-	6.0	ns

### 6. ELECTRICAL CHARACTERISTICS CURVES

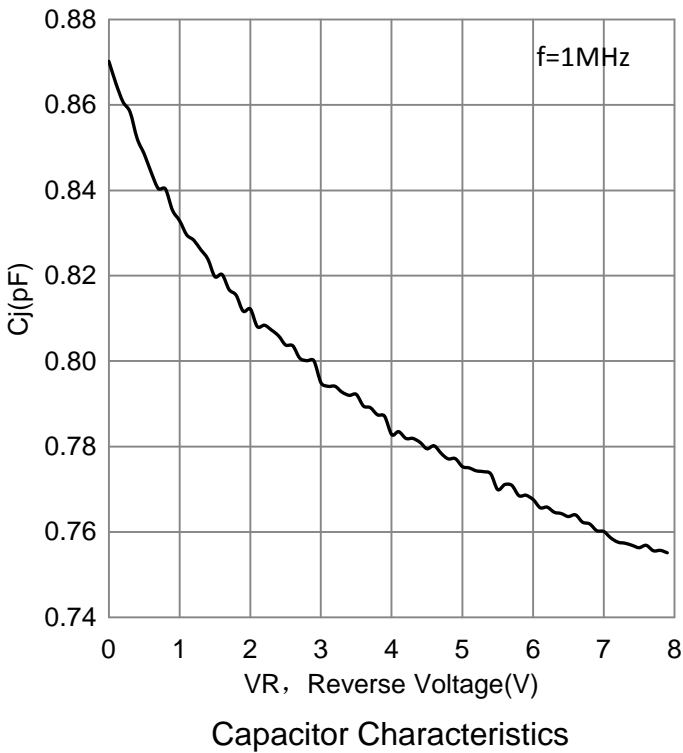
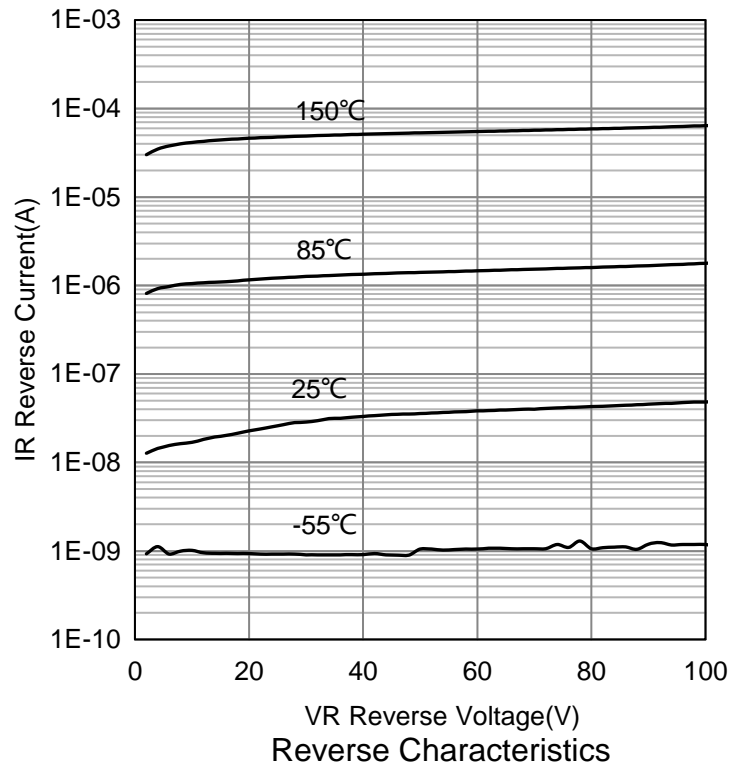
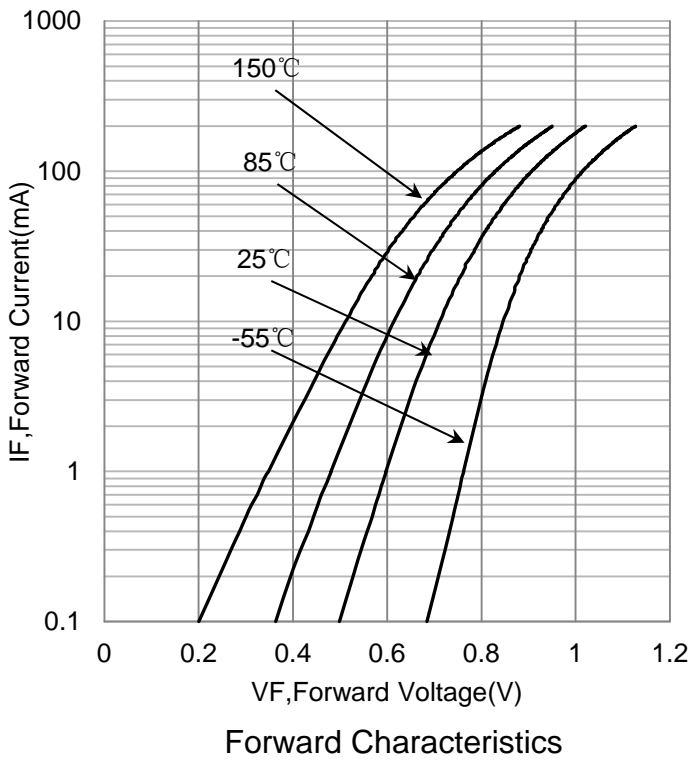

### 7. OUTLINE AND DIMENSIONS

Notes:

1. DIMENSIONING AND TOLERANCING PER ANSI Y14.5M, 1982.
2. CONTROLLING DIMENSION: MILLIMETERS.
3. MAXIMUM LEAD THICKNESS INCLUDES LEAD FINISH. MINIMUM LEAD THICKNESS IS THE MINIMUM THICKNESS OF BASE MATERIAL.
4. DIMENSIONS D AND E DO NOT INCLUDE MOLD FLASH, PROTRUSIONS OR GATE BURRS.

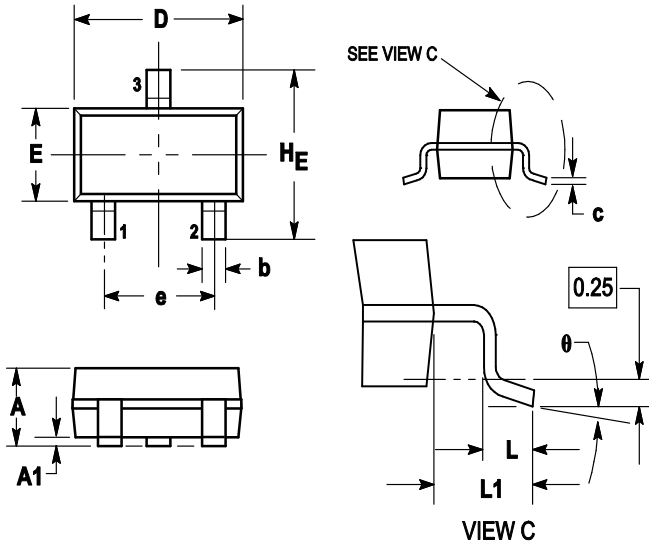

DIM	MILLIMETERS			INCHES		
	MIN	NOM	MAX	MIN	NOM	MAX
A	0.89	1	1.11	0.035	0.04	0.044
A1	0.01	0.06	0.1	0.001	0.002	0.004
b	0.37	0.44	0.5	0.015	0.018	0.02
c	0.09	0.13	0.18	0.003	0.005	0.007
D	2.80	2.9	3.04	0.11	0.114	0.12
E	1.20	1.3	1.4	0.047	0.051	0.055
e	1.78	1.9	2.04	0.07	0.075	0.081
L	0.10	0.2	0.3	0.004	0.008	0.012
L1	0.35	0.54	0.69	0.014	0.021	0.029
HE	2.10	2.4	2.64	0.083	0.094	0.104
theta	0°	---	10°	0°	---	10°

### 8. SOLDERING FOOTPRINT

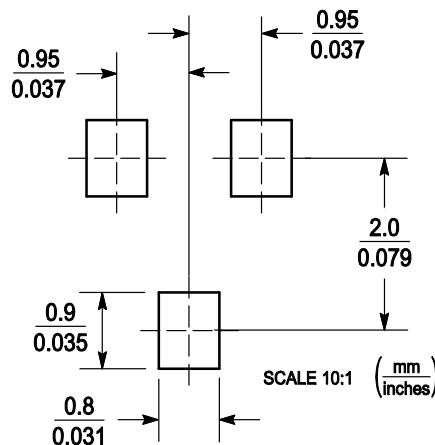

## **DISCLAIMER**

- Curve guarantee in the specification. The curve of test items with electric parameter is used as quality guarantee. The curve of test items without electric parameter is used as reference only.
- Before you use our Products for new Project, you are requested to carefully read this document and fully understand its contents. LRC shall not be in any way responsible or liable for failure, malfunction or accident arising from the use of any LRC's Products against warning, caution or note contained in this document.
- All information contained in this document is current as of the issuing date and subject to change without any prior notice. Before purchasing or using LRC's Products, please confirm the latest information with a LRC sales representative.

单击下面可查看定价，库存，交付和生命周期等信息

[>>LRC\(乐山无线电\)](#)