

LMBTA06LT1G

S-LMBTA06LT1G

Driver Transistors

1. FEATURES

- We declare that the material of product compliance with RoHS requirements and Halogen Free.
- S- prefix for automotive and other applications requiring unique site and control change requirements; AEC-Q101 qualified and PPAP capable.

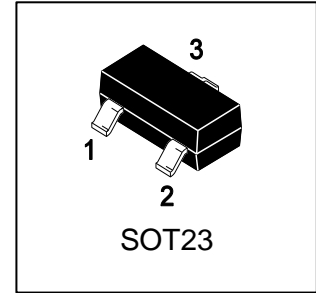

2. DEVICE MARKING AND ORDERING INFORMATION

Device	Marking	Shipping
LMBTA06LT1G	1GM	3000/Tape&Reel
LMBTA06LT3G	1GM	10000/Tape&Reel

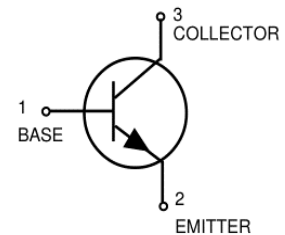

3. MAXIMUM RATINGS(Ta = 25°C)

Parameter	Symbol	Limits	Unit
Collector-Emitter Voltage	VCEO	80	V
Collector-Base voltage	VCBO	80	V
Emitter-Base Voltage	VEBO	4	V
Collector current-continuoun	IC	500	mA

4. THERMAL CHARACTERISTICS

Parameter	Symbol	Value	Unit
Total Device Dissipation FR-5 Board (Note 1) TA = 25°C	PD	225	mW
Derate above 25°C		1.8	mW/°C
Thermal Resistance, Junction to Ambient	RθJA	556	°C/W
Total Device Dissipation Alumina Substrate(Note 2) TA = 25°C	PD	300	mW
Derate above 25°C		2.4	mW/°C
Thermal Resistance, Junction to Ambient	RθJA	417	°C/W
Junction and Storage Temperature	TJ , Tstg	-55~+150	°C

1. FR-5 = 1.0 x 0.75 x 0.062 in.

2. Alumina = 0.4 x 0.3 x 0.024 in. 99.5% alumina.

5. ELECTRICAL CHARACTERISTICS (Ta= 25°C)

Characteristic	Symbol	Min.	Typ.	Max.	Unit
OFF CHARACTERISTICS					
Collector–Emitter Breakdown Voltage(Note 3) (IC =1.0 mA, IB = 0)	V(BR)CEO	80	-	-	V
Emitter–Base Breakdown Voltage (IE = 100 μA, IC = 0)	V(BR)EBO	4	-	-	V
Collector Cutoff Current (VCE = 60V, IB = 0)	ICES	-	-	0.1	μA
Emitter Cutoff Current (VCB = 80V, IE = 0)	ICBO	-	-	0.1	μA
ON CHARACTERISTICS					
DC Current Gain (IC = 10 mA, VCE = 1.0 V) (IC = 100 mA, VCE = 1.0 V)	hFE	100 100	- -	- -	
Collector–Emitter Saturation Voltage (IC = 100 mA, IB = 10 mA)	VCE(sat)	-	-	0.25	V
Base–Emitter On Voltage (IC = 100 mA, VCE = 1.0 V)	VBE(sat)	-	-	1.2	V
SMALL–SIGNAL CHARACTERISTICS					
Current –Gain – Bandwidth Product(Note 4) (VCE = 2.0 V, IC = 10mA, f = 100 MHz)	fT	100	-	-	MHz

3. Pulse Test: Pulse Width $\leq 300 \mu\text{s}$, Duty Cycle $\leq 2.0\%$.

4. fT is defined as the frequency at which |hfe| extrapolates to unity.

6.ELECTRICAL CHARACTERISTICS CURVES

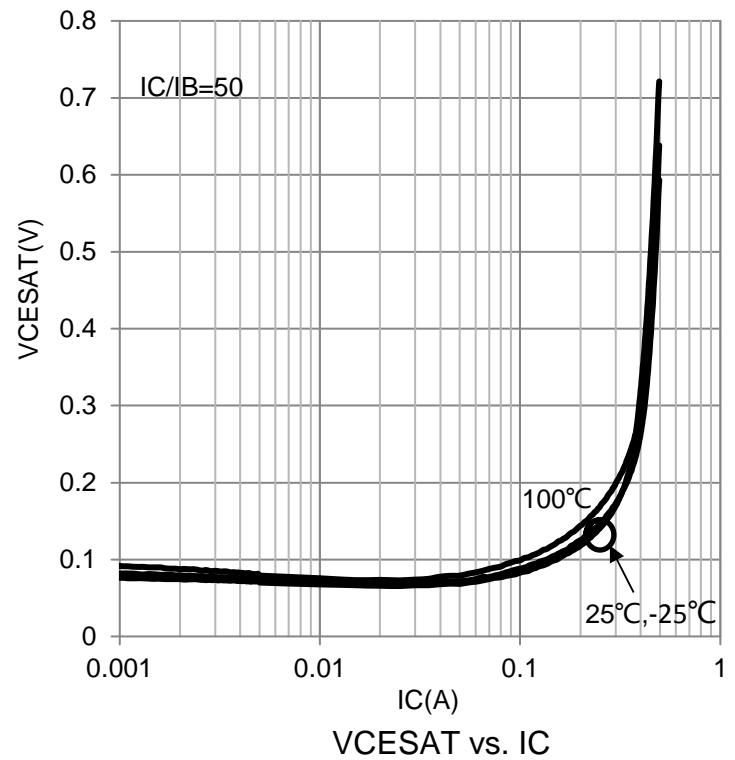
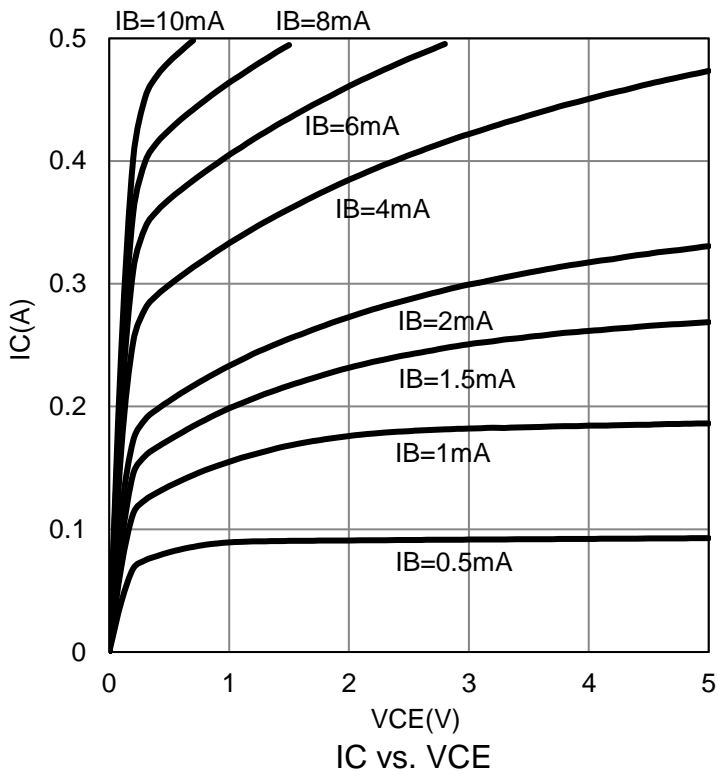
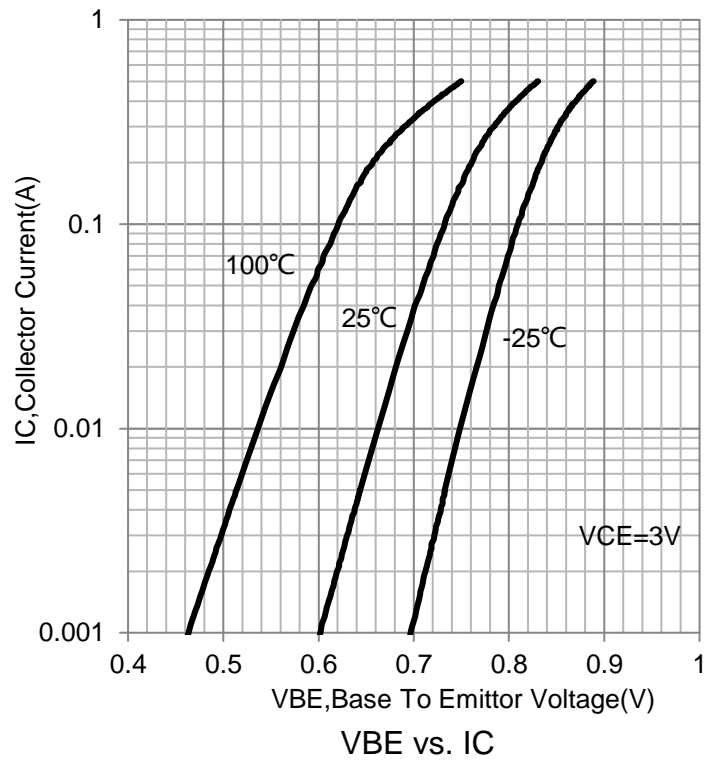
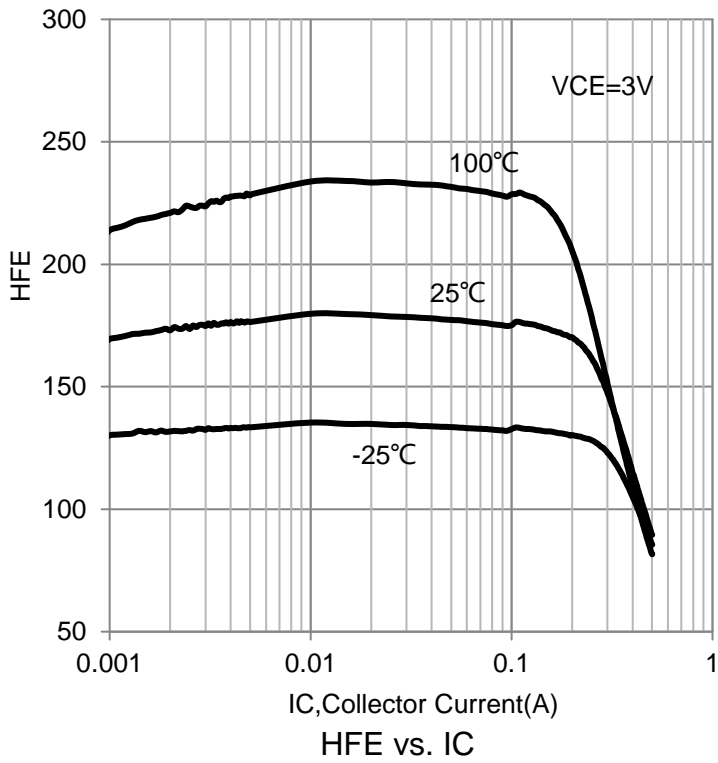

6.ELECTRICAL CHARACTERISTICS CURVES(Con.)

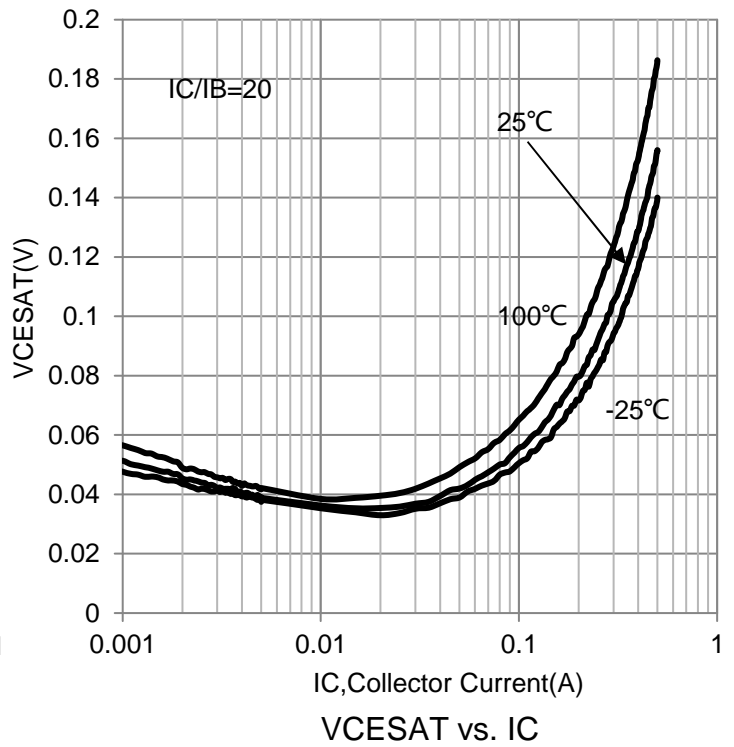
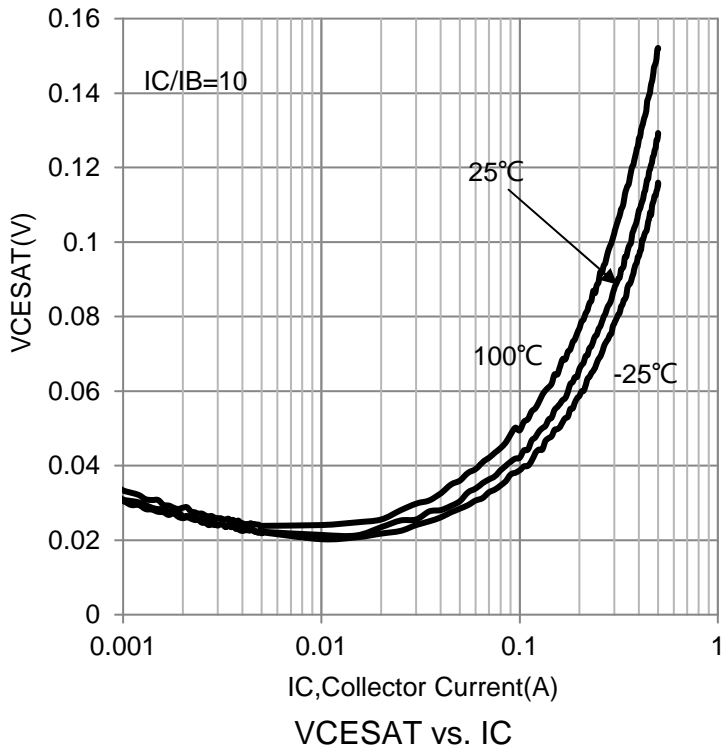

7.OUTLINE AND DIMENSIONS

Notes:

1. DIMENSIONING AND TOLERANCING PER ANSI Y14.5M, 1982.
2. CONTROLLING DIMENSION: MILLIMETERS.
3. MAXIMUM LEAD THICKNESS INCLUDES LEAD FINISH. MINIMUM LEAD THICKNESS IS THE MINIMUM THICKNESS OF BASE MATERIAL.
4. DIMENSIONS D AND E DO NOT INCLUDE MOLD FLASH, PROTRUSIONS OR GATE BURRS.

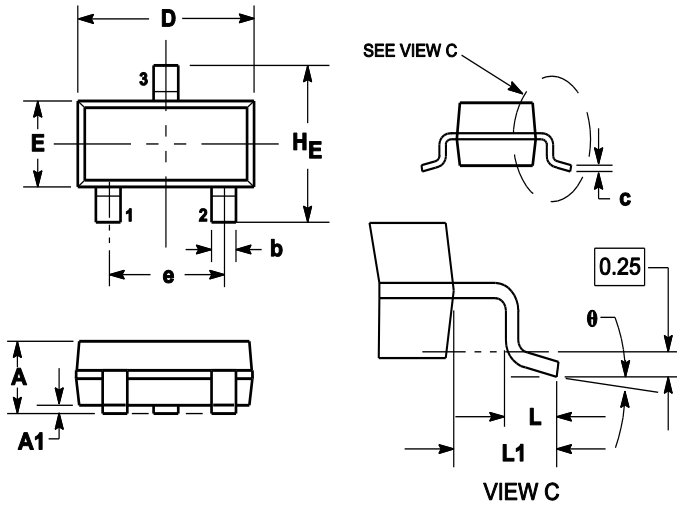

DIM	MILLIMETERS			INCHES		
	MIN	NOM	MAX	MIN	NOM	MAX
A	0.89	1	1.11	0.035	0.04	0.044
A1	0.01	0.06	0.1	0.001	0.002	0.004
b	0.37	0.44	0.5	0.015	0.018	0.02
c	0.09	0.13	0.18	0.003	0.005	0.007
D	2.80	2.9	3.04	0.11	0.114	0.12
E	1.20	1.3	1.4	0.047	0.051	0.055
e	1.78	1.9	2.04	0.07	0.075	0.081
L	0.10	0.2	0.3	0.004	0.008	0.012
L1	0.35	0.54	0.69	0.014	0.021	0.029
HE	2.10	2.4	2.64	0.083	0.094	0.104
θ	0°	---	10°	0°	---	10°

8.SOLDERING FOOTPRINT

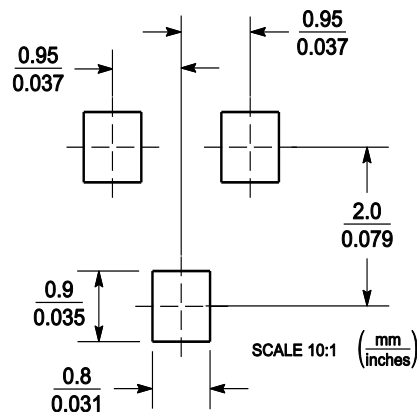

单击下面可查看定价，库存，交付和生命周期等信息

[>>LRC\(乐山无线电\)](#)