

LMUN5233T1G

S-LMUN5233T1G

Bias Resistor Transistor
NPN Silicon Surface Mount Transistor
with Monolithic Bias Resistor Network

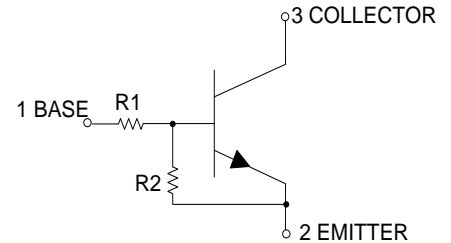
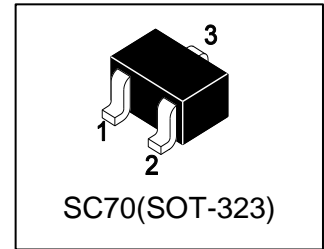

1. FEATURES

- Simplifies circuit design
- Reduces board space and component count
- The SC-70/SOT-323 package can be soldered using wave or reflow.
- The modified gull-winged leads absorb thermal stress during soldering eliminating the possibility of damage to the die.
- We declare that the material of product compliance with RoHS requirements and Halogen Free.
- S- prefix for automotive and other applications requiring unique site and control change requirements; AEC-Q101 qualified and PPAP capable.

2. DEVICE MARKING AND RESISTOR VALUES

Device	Marking	R1(K)	R2(K)	Vin(V)	Shipping
LMUN5233T1G	8K	4.7	47	-5 ~+30	3000/Tape&Reel
LMUN5233T3G	8K	4.7	47	-5 ~+30	10000/Tape&Reel

3. MAXIMUM RATINGS(Ta = 25°C)

Parameter	Symbol	Limits	Unit
Collector-Emitter Voltage	V _{CEO}	50	V
Collector-Base Voltage	V _{CB0}	50	V
Collector Current — Continuous	I _C	100	mA

4. THERMAL CHARACTERISTICS

Parameter	Symbol	Limits	Unit
Total Device Dissipation, FR-5 Board (Note 1) @ TA = 25°C Derate above 25°C	PD	202 1.6	mW mW/°C
Thermal Resistance, Junction-to-Ambient(Note 1)	R _{θJA}	618	°C/W
Junction and Storage temperature	T _J , T _{stg}	-55~+150	°C

1. FR-5 @ Minimum Pad.

5. ELECTRICAL CHARACTERISTICS (Ta= 25°C)

OFF CHARACTERISTICS

Characteristic	Symbol	Min.	Typ.	Max.	Unit
Collector–Emitter Breakdown Voltage (IC = 2.0 mA, IB = 0)	VBR(CEO)	50	-	-	V
Collector–Base Breakdown Voltage (IC = 10 μA, IE = 0)	VBR(CBO)	50	-	-	V
Collector-Base Cutoff Current (VCB = 50 V, IE = 0)	ICBO	-	-	100	nA
Collector-Emitter Cutoff Current (VCE = 50 V, IB = 0)	ICEO	-	-	500	nA
Emitter-Base Cutoff Current (VEB = 6.0 V, IC = 0)	IEBO	-	-	0.18	mA

ON CHARACTERISTICS (Note 2.)

DC Current Gain (IC = 5.0 mA, VCE = 10 V)	HFE	80	200	-	
Collector–Emitter Saturation Voltage (IC = 10 mA, IB = 1 mA)	VCE(sat)	-	-	0.25	V
Output Voltage (on) (VCC = 5.0 V, VB = 2.5 V, RL = 1.0KΩ)	VOL	-	-	0.2	V
Output Voltage(off) (VCC = 5.0 V, VB = 0.25 V, RL = 1.0KΩ)	VOH	4.9	-	-	V
Input Voltage(off) (VCE=5.0V, IC=100μA)	Vi(off)	-	-	0.5	V
Input Voltage(on) (VCE=0.3V, IC=5.0mA)	Vi(on)	1.3	-	-	V
Input Resistor	R1	3.3	4.7	6.1	KΩ
Resistor Ratio	R1/R2	0.055	0.1	0.185	

2. Pulse Test: Pulse Width < 300 μs, Duty Cycle < 2.0%

6. ELECTRICAL CHARACTERISTICS CURVES

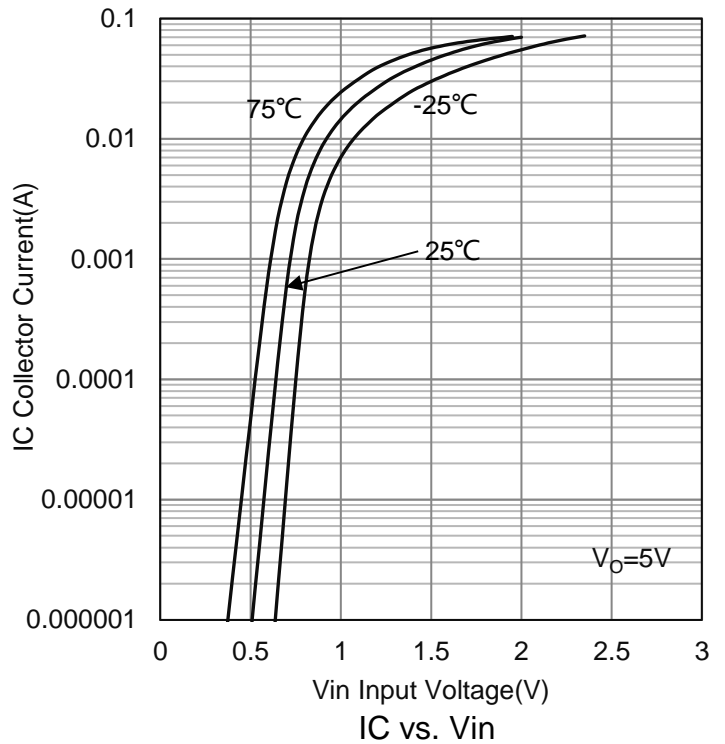
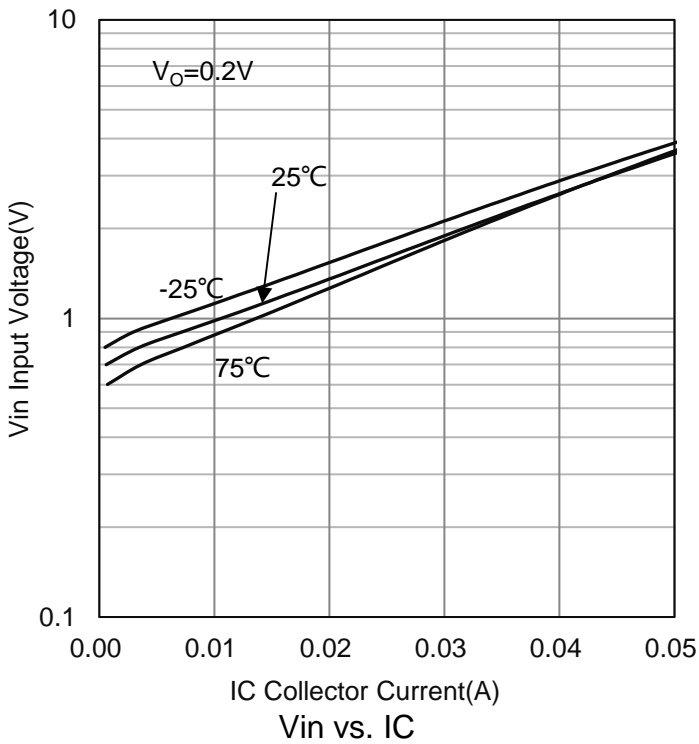
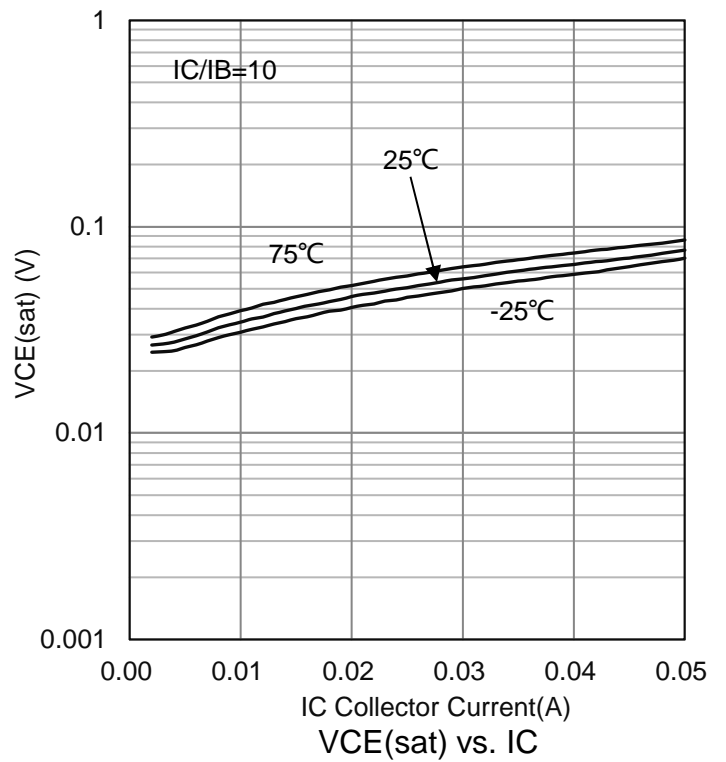
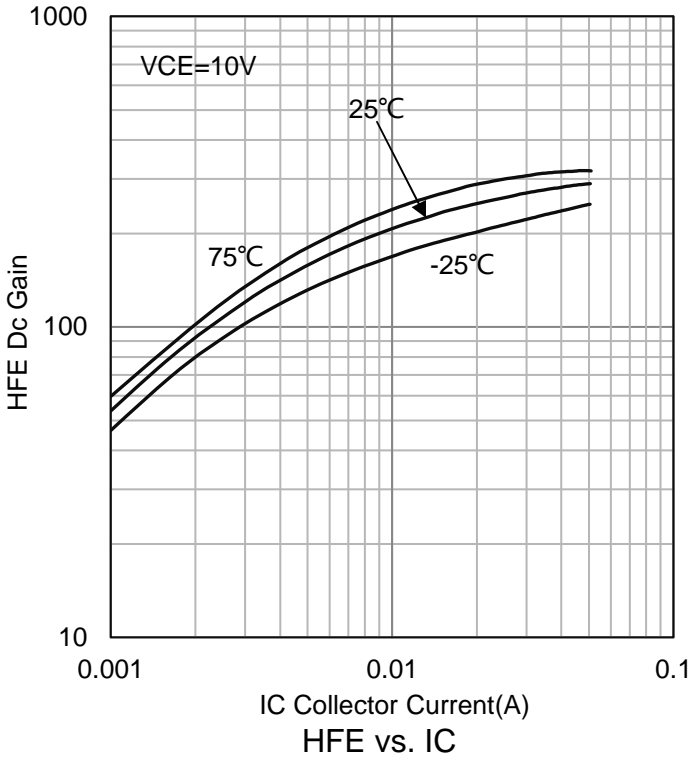

6. ELECTRICAL CHARACTERISTICS CURVES(Con.)

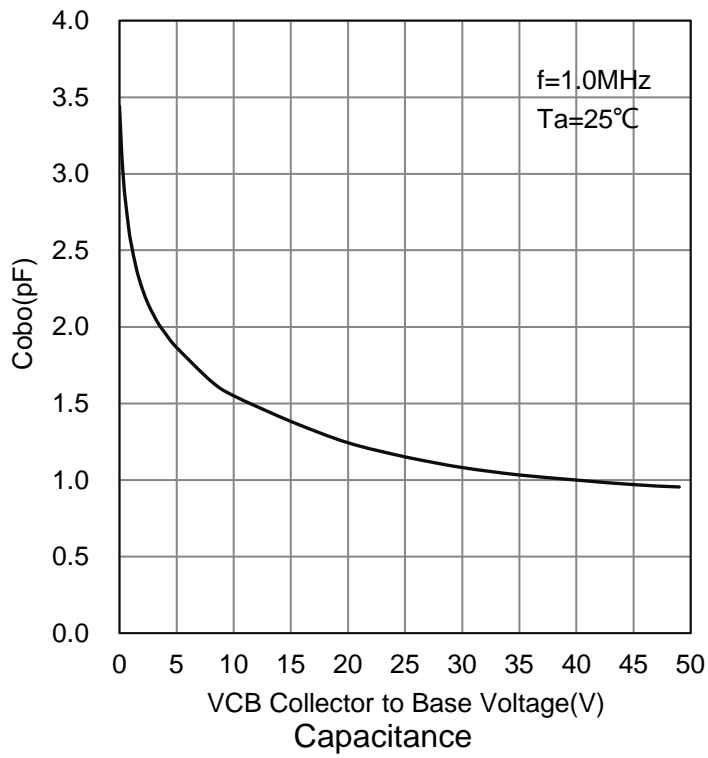

7. OUTLINE AND DIMENSIONS

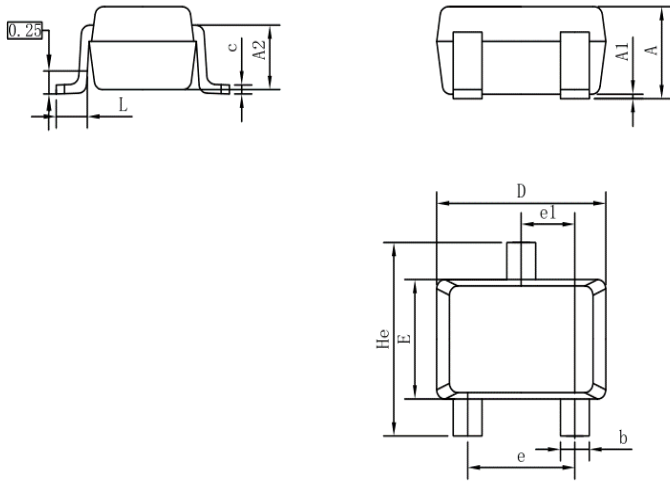

SC70			
DIM	MIN	NOR	MAX
A	0.80	0.95	1.00
A1	0.00	0.05	0.10
A2	0.7 REF		
b	0.30	0.35	0.40
c	0.10	0.15	0.25
D	1.80	2.05	2.20
E	1.15	1.30	1.35
e	1.20	1.30	1.40
e1	0.65 BSC		
L	0.20	0.35	0.56
He	2.00	2.10	2.40
ALL Dimension in mm			

8. SOLDERING FOOTPRINT

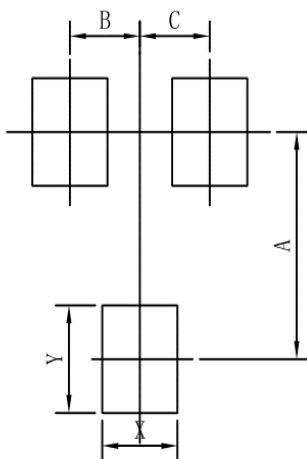

SC70	
DIM	MIN
A	1.90
B	0.65
C	0.65
X	0.70
Y	0.90

DISCLAIMER

- Curve guarantee in the specification. The curve of test items with electric parameter is used as quality guarantee. The curve of test items without electric parameter is used as reference only.
- Before you use our Products for new Project, you are requested to carefully read this document and fully understand its contents. LRC shall not be in any way responsible or liable for failure, malfunction or accident arising from the use of any LRC's Products against warning, caution or note contained in this document.
- All information contained in this document is current as of the issuing date and subject to change without any prior notice. Before purchasing or using LRC's Products, please confirm the latest information with a LRC sales representative.

单击下面可查看定价，库存，交付和生命周期等信息

[>>LRC\(乐山无线电\)](#)