

LP3443LT1G

S-LP3443LT1G

20V P-Channel Enhancement-Mode MOSFET

1. FEATURES

- $V_{DS} = -20V$
- $R_{DS(ON)} \leq 70m\Omega, @V_{GS} = -4.5V, I_{DS} = -4.7A$
- $R_{DS(ON)} \leq 110m\Omega, @V_{GS} = -2.5V, I_{DS} = -1.0A$
- We declare that the material of product compliance with RoHS requirements and Halogen Free.
- S- prefix for automotive and other applications requiring unique site and control change requirements; AEC-Q101 qualified and PPAP capable.
- ESD rating of class 0 (<100V) per Human Body Model

2. APPLICATIONS

- Advanced trench process technology
- High density cell design for ultra low on-resistance.

3. DEVICE MARKING AND ORDERING INFORMATION

Device	Marking	Shipping
LP3443LT1G	P34	3000/Tape&Reel
LP3443LT3G	P34	10000/Tape&Reel

4. MAXIMUM RATINGS($T_a = 25^\circ C$)

Parameter	Symbol	Limits	Unit
Drain-Source Voltage	V_{DSS}	-20	V
Gate-to-Source Voltage – Continuous	V_{GS}	± 12	V
Drain Current			A
– Continuous $T_a = 25^\circ C$	I_D	-4.7	
– Pulsed (Note 1)	I_{DM}	-20	

5. THERMAL CHARACTERISTICS

Parameter	Symbol	Limits	Unit
Power Dissipation	PD	1.1	W
		0.7	W
Thermal Resistance, Junction-to-Ambient (Note 2)	$R_{\theta JA}$	110	$^\circ C/W$
Junction and Storage temperature	T_J, T_{stg}	-55~+150	$^\circ C$

1. Repetitive Rating: Pulse width limited by the maximum junction temperature.

2. 1-in² 2oz Cu PCB board.

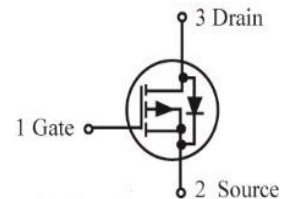
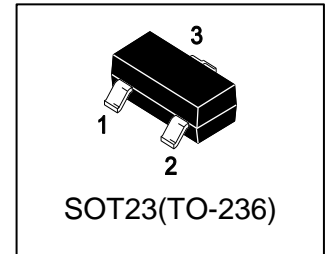

6. ELECTRICAL CHARACTERISTICS (Ta= 25°C)

Characteristic	Symbol	Min.	Typ.	Max.	Unit
STATIC					
Drain–Source Breakdown Voltage (VGS = 0, ID = -250μA)	VBRDSS	-20	-	-	V
Gate Threshold Voltage (VDS = VGS, ID = -250μA)	VGS(th)	-0.6	-0.85	-1.4	V
Zero Gate Voltage Drain Current (VGS = 0, VDS = -20 V)	IDSS	-	-	-1	μA
Gate-to–Source Leakage Current (VDS = 0 V, VGS = ±12 V)	IGSS	-	-	±100	nA
Static Drain–Source On–State Resistance(Note 3) (VGS = -4.5V, ID = -4.7A) (VGS = -2.7V, ID = -3.8A) (VGS = -2.5V, ID = -1.0A)	RDS(on)	-	58 63 75	70 90 110	mΩ
Diode Forward Voltage (VGS = 0 V, ISD = -1.7 A)	VSD	-	-	-1.2	V
DYNAMIC					
Total Gate Charge@10V	Qg	-	16.6	-	nC
Total Gate Charge@4.5V	Qg	-	8	-	(VDS = -10V, ID = -1.5A)
Gate-to–Source Gate Charge	Qgs	-	0.9	-	
Gate-to–Drain Charge	Qgd	-	2.7	-	
Turn-On Delay Time	td(on)	-	15.7	-	
Rise Time	tr	-	13	-	
Turn-Off Delay Time	td(off)	-	70	-	
Fall Time	tf	-	17.5	-	
Input Capacitance	Ciss	-	797.3	-	(f = 200kHz, VDS = -10 V)
Output Capacitance	Coss	-	88.5	-	
Reverse Transfer Capacitance	Crss	-	74.8	-	
Forward Transconductance (VDS = -10V, ID = -4.7A)	gfs	-	8	-	S
Body Diode Reverse Recovery Time (IF = -4A, di/dt = 80A/μs)	trr	-	22.15	-	ns
Body Diode Reverse Recovery Charge (IF = -4A, di/dt = 80A/μs)	Qrr	-	6.61	-	nC
Gate-Resistance (VDS = 0 V, VGS = 0 V, f = 1MHz)	Rg	-	8.6	-	Ω

3. Pulse Test: Pulse Width ≤ 300 μs, Duty Cycle ≤ 2.0%.

7. ELECTRICAL CHARACTERISTICS CURVES

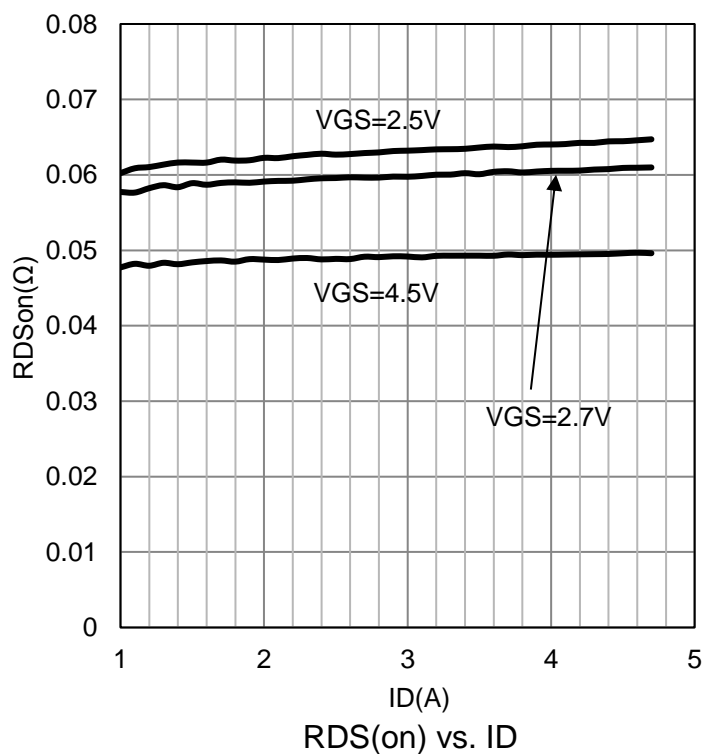
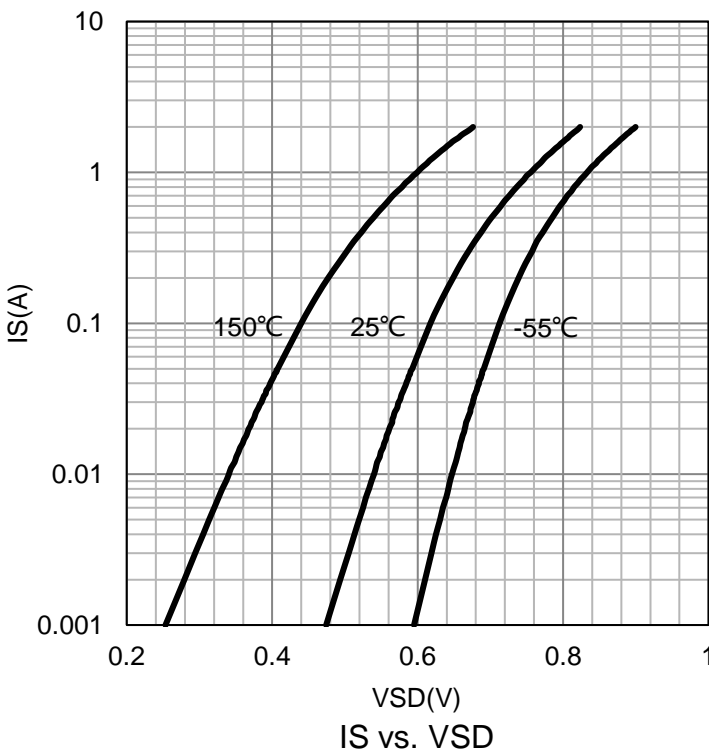
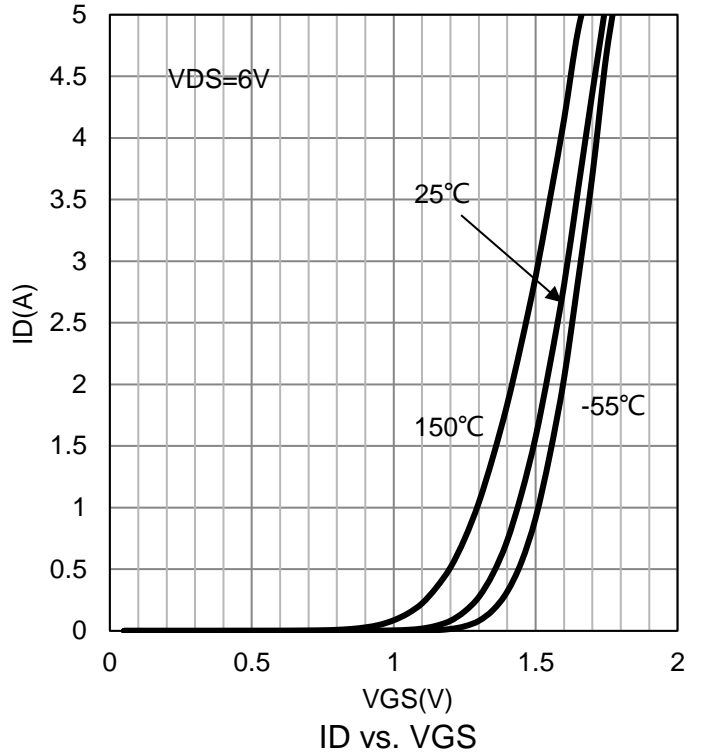
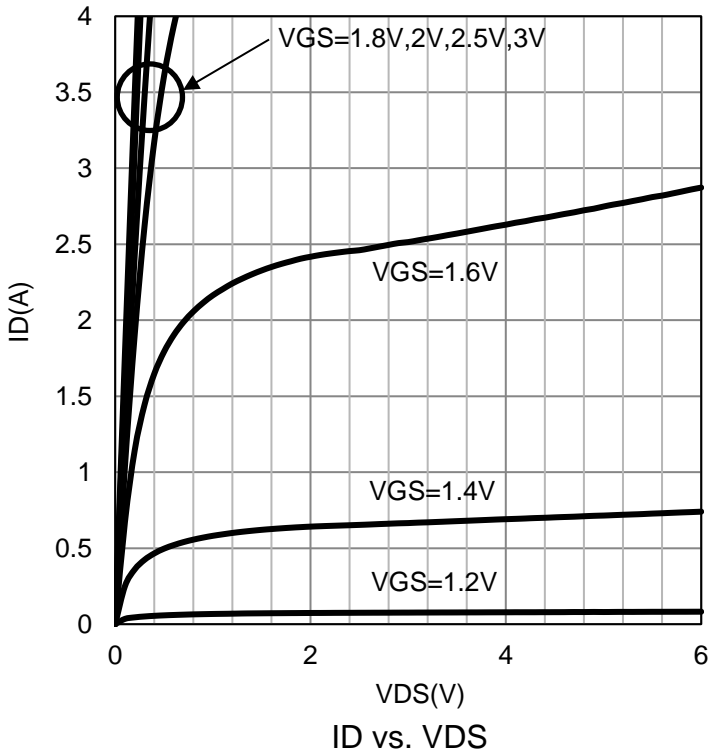

7. ELECTRICAL CHARACTERISTICS CURVES(Con.)

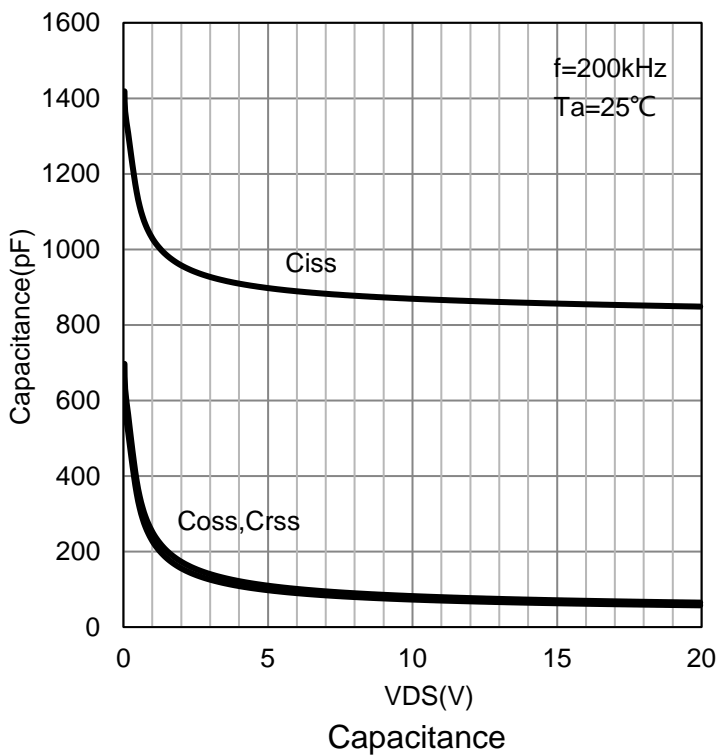
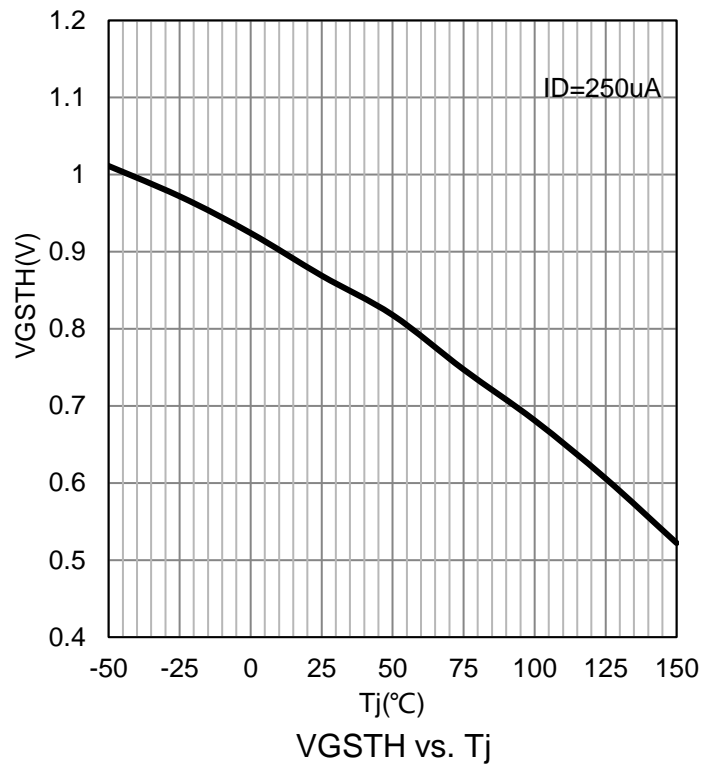
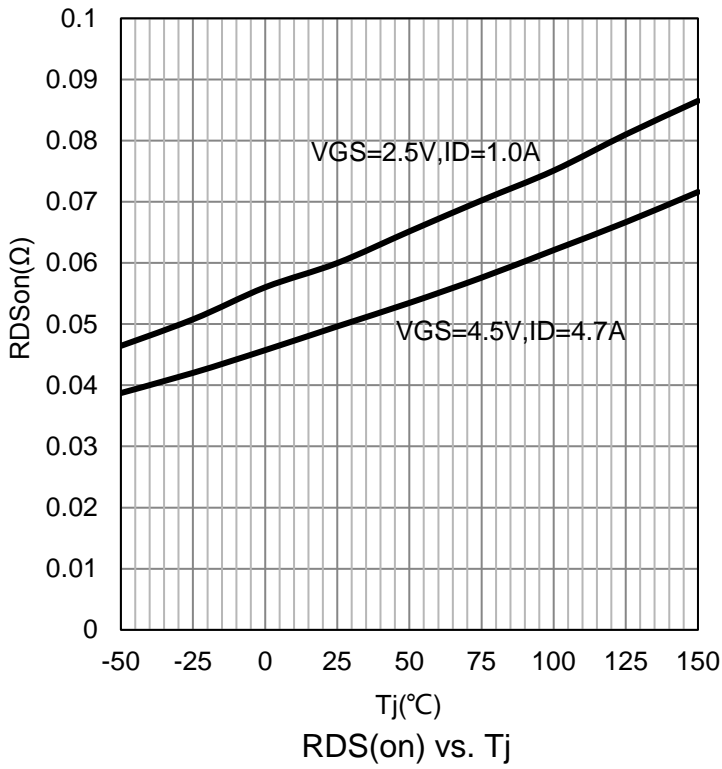

7. ELECTRICAL CHARACTERISTICS CURVES(Con.)

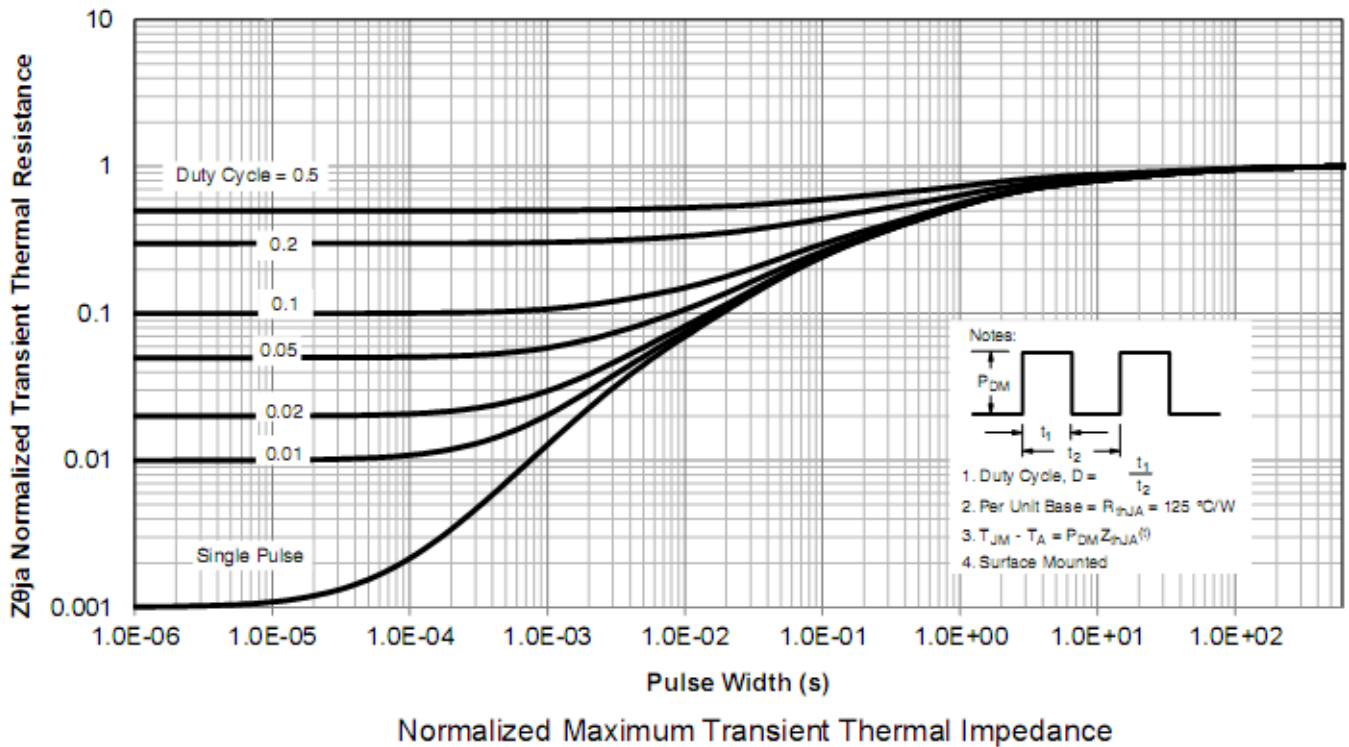
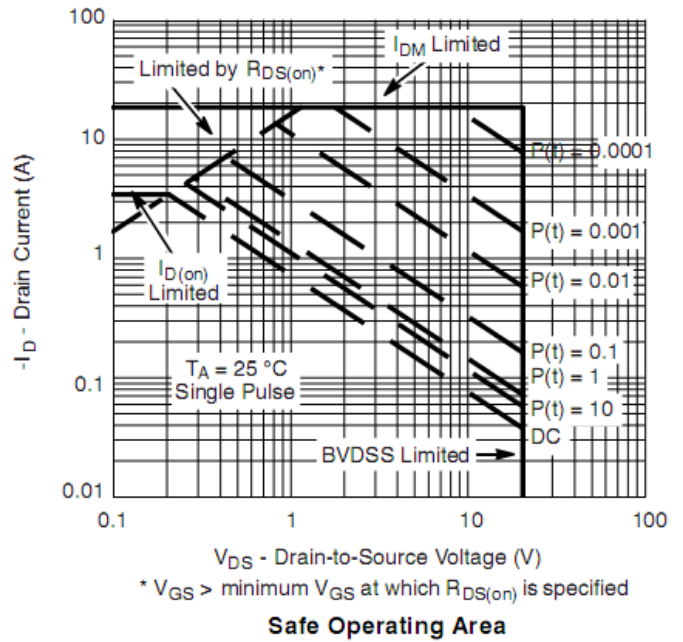
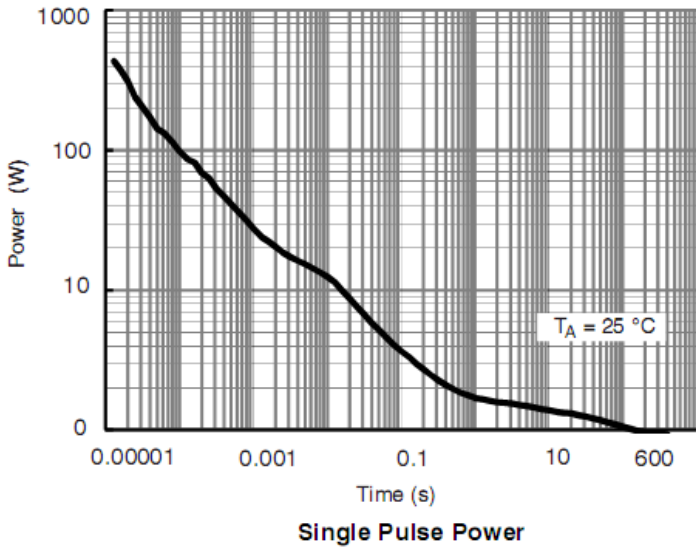

8. OUTLINE AND DIMENSIONS

Notes:

1. DIMENSIONING AND TOLERANCING PER ANSI Y14.5M, 1982.
2. CONTROLLING DIMENSION: MILLIMETERS.
3. MAXIMUM LEAD THICKNESS INCLUDES LEAD FINISH. MINIMUM LEAD THICKNESS IS THE MINIMUM THICKNESS OF BASE MATERIAL.
4. DIMENSIONS D AND E DO NOT INCLUDE MOLD FLASH, PROTRUSIONS OR GATE BURRS.

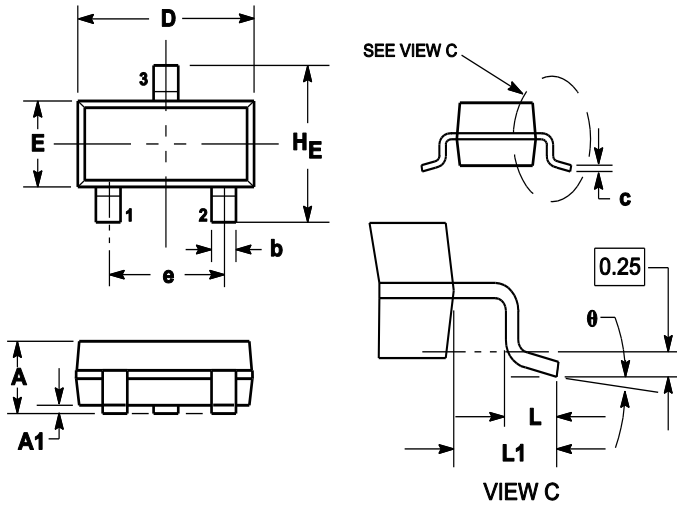

DIM	MILLIMETERS			INCHES		
	MIN	NOM	MAX	MIN	NOM	MAX
A	0.89	1	1.11	0.035	0.04	0.044
A1	0.01	0.06	0.1	0.001	0.002	0.004
b	0.37	0.44	0.5	0.015	0.018	0.02
c	0.09	0.13	0.18	0.003	0.005	0.007
D	2.80	2.9	3.04	0.11	0.114	0.12
E	1.20	1.3	1.4	0.047	0.051	0.055
e	1.78	1.9	2.04	0.07	0.075	0.081
L	0.10	0.2	0.3	0.004	0.008	0.012
L1	0.35	0.54	0.69	0.014	0.021	0.029
HE	2.10	2.4	2.64	0.083	0.094	0.104
θ	0°	---	10°	0°	---	10°

9. SOLDERING FOOTPRINT

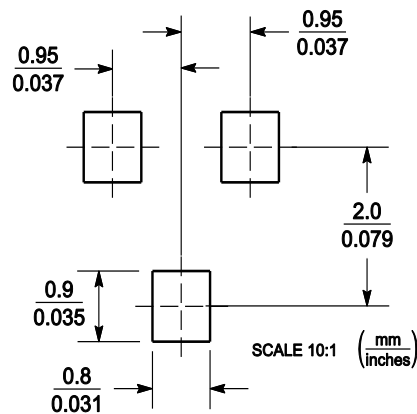

单击下面可查看定价，库存，交付和生命周期等信息

[>>LRC\(乐山无线电\)](#)

[>>点击查看相关商品](#)