

# LMBTA56LT1G

## S-LMBTA56LT1G

Driver Transistors PNP Silicon

### 1. FEATURES

- We declare that the material of product compliance with RoHS requirements and Halogen Free.
- S- prefix for automotive and other applications requiring unique site and control change requirements; AEC-Q101 qualified and PPAP capable.

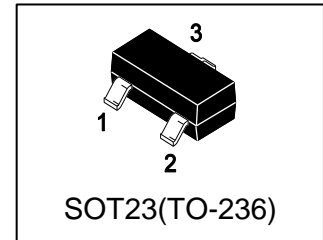

### 2. DEVICE MARKING AND ORDERING INFORMATION

Device	Marking	Shipping
LMBTA56LT1G	2GM	3000/Tape&Reel
LMBTA56LT3G	2GM	10000/Tape&Reel

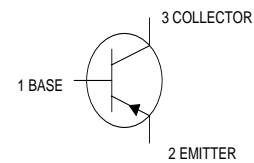

### 3. MAXIMUM RATINGS(Ta = 25°C)

Parameter	Symbol	Limits	Unit
Collector–Emitter Voltage	V <sub>CEO</sub>	-80	V <sub>dc</sub>
Collector–Base Voltage	V <sub>CBO</sub>	-80	V <sub>dc</sub>
Emitter–Base Voltage	V <sub>EBO</sub>	-4	V <sub>dc</sub>
Collector Current — Continuous	I <sub>C</sub>	-500	mA <sub>dc</sub>

### 4. THERMAL CHARACTERISTICS

Parameter	Symbol	Limits	Unit
Total Device Dissipation, FR-5 Board (Note 1) @ TA = 25°C Derate above 25°C	PD	225 1.8	mW mW/°C
Thermal Resistance, Junction–to–Ambient(Note 1)	R <sub>θJA</sub>	556	°C/W
Junction and Storage temperature	T <sub>J</sub> , T <sub>stg</sub>	-55~+150	°C

1. FR-5 = 1.0×0.75×0.062 in.

**5. ELECTRICAL CHARACTERISTICS (Ta= 25°C)**

Characteristic	Symbol	Min.	Typ.	Max.	Unit
Collector–Emitter Breakdown Voltage(Note 2) (IC = -1 mAdc, IB = 0)	VBR(CEO)	-80	-	-	V
Emitter–Base Breakdown Voltage (IE = -100 µAdc, IC = 0)	VBR(EBO)	-4	-	-	V
Collector Cutoff Current (VCE = - 60 Vdc, IE = 0)	ICES	-	-	-0.1	µA
Collector Cutoff Current (VCB = - 80 Vdc, IE = 0)	ICBO	-	-	-0.1	µA
DC Current Gain (IC = -10 mAdc, VCE = -1 Vdc) (IC = -100 mAdc, VCE = -1 Vdc)	HFE	100 100	- -	- -	
Collector–Emitter Saturation Voltage (IC = -100 mAdc, IB = -10 mAdc)	VCE(sat)	-	-	-0.25	V
Base–Emitter Saturation Voltage (IC = -100 mAdc, VCE = -1 Vdc)	VBE(sat)	-	-	-1.2	V
Current–Gain — Bandwidth Product (IC = -100mAdc, VCE= -1Vdc, f = 100MHz)	fT	50	-	-	MHz

 2.Pulse Test: Pulse Width  $\leq 300 \mu\text{s}$ , Duty Cycle  $\leq 2.0\%$ .

**6. ELECTRICAL CHARACTERISTICS CURVES**

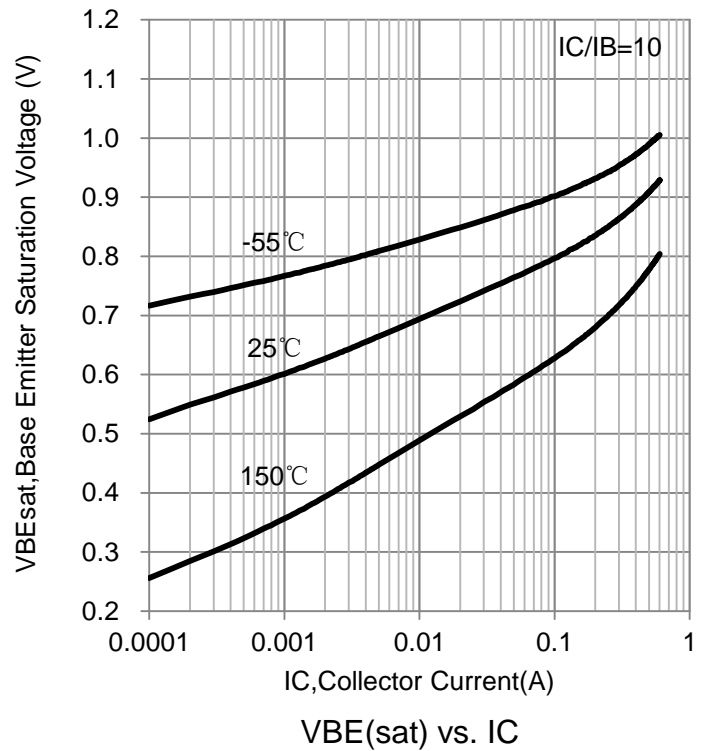
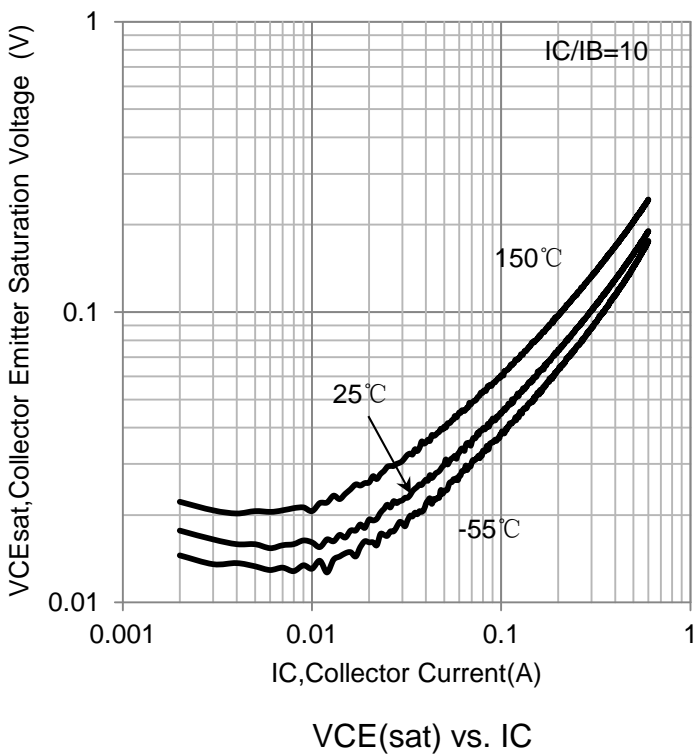
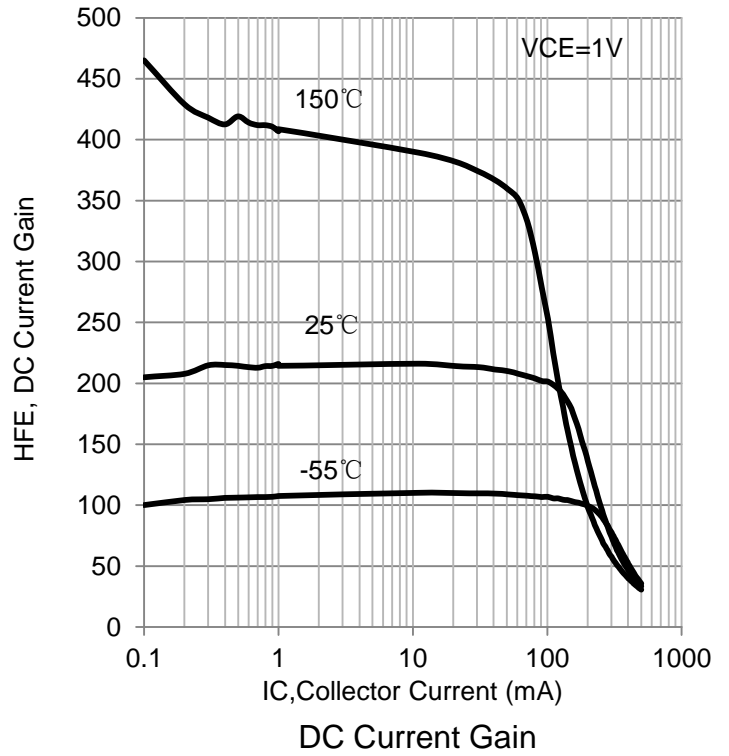
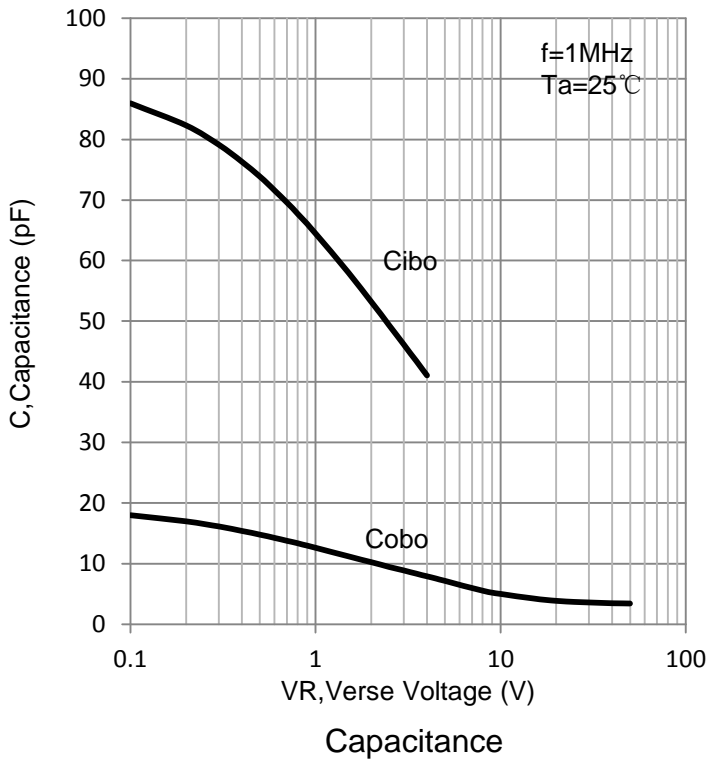

**6. ELECTRICAL CHARACTERISTICS CURVES(Con.)**

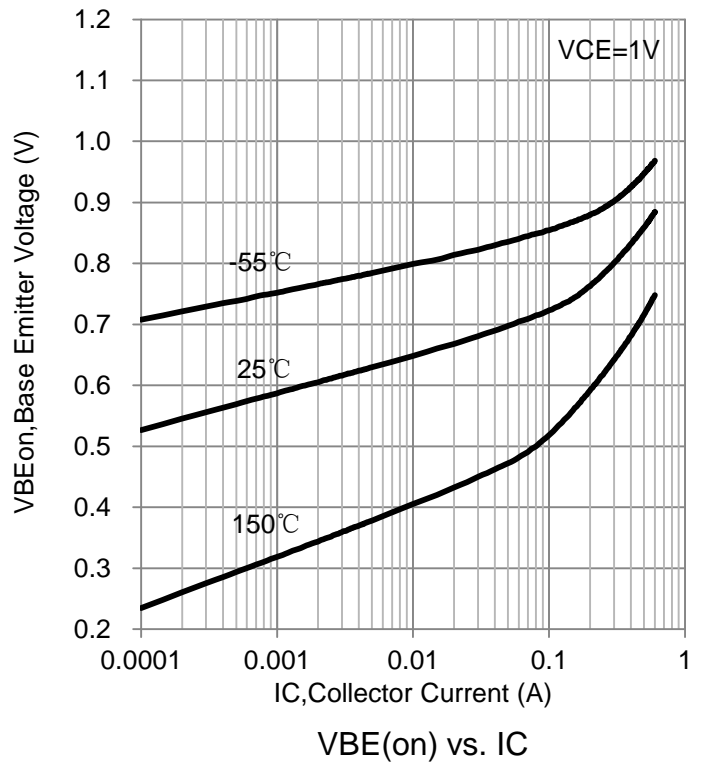
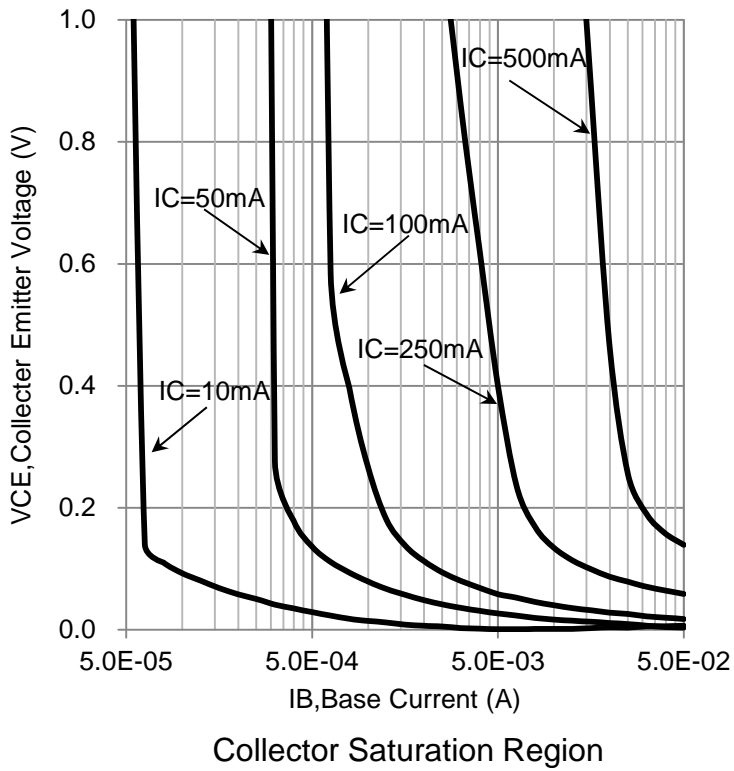

**7. OUTLINE AND DIMENSIONS**

Notes:

1. DIMENSIONING AND TOLERANCING PER ANSI Y14.5M, 1982.
2. CONTROLLING DIMENSION: MILLIMETERS.
3. MAXIMUM LEAD THICKNESS INCLUDES LEAD FINISH. MINIMUM LEAD THICKNESS IS THE MINIMUM THICKNESS OF BASE MATERIAL.
4. DIMENSIONS D AND E DO NOT INCLUDE MOLD FLASH, PROTRUSIONS OR GATE BURRS.

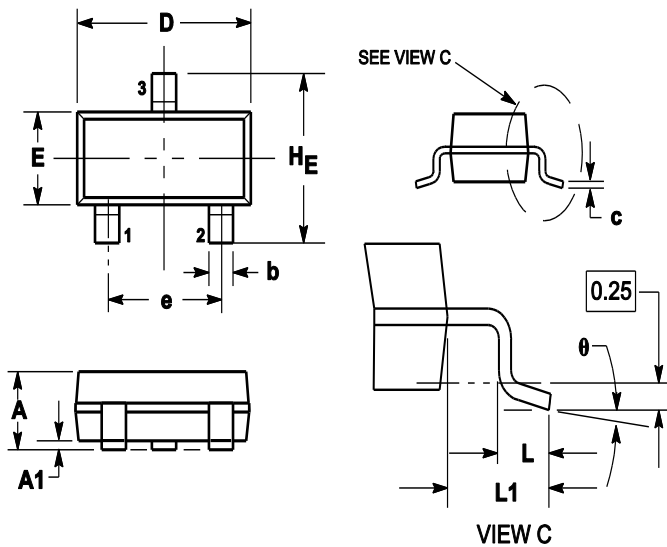

DIM	MILLIMETERS			INCHES		
	MIN	NOM	MAX	MIN	NOM	MAX
A	0.89	1	1.11	0.035	0.04	0.044
A1	0.01	0.06	0.1	0.001	0.002	0.004
b	0.37	0.44	0.5	0.015	0.018	0.02
c	0.09	0.13	0.18	0.003	0.005	0.007
D	2.80	2.9	3.04	0.11	0.114	0.12
E	1.20	1.3	1.4	0.047	0.051	0.055
e	1.78	1.9	2.04	0.07	0.075	0.081
L	0.10	0.2	0.3	0.004	0.008	0.012
L1	0.35	0.54	0.69	0.014	0.021	0.029
HE	2.10	2.4	2.64	0.083	0.094	0.104
θ	0°	---	10°	0°	---	10°

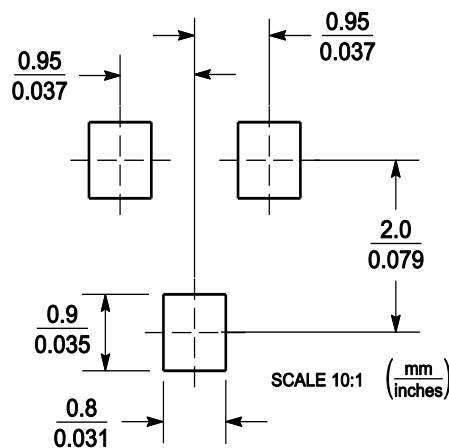
**8. SOLDERING FOOTPRINT**

单击下面可查看定价，库存，交付和生命周期等信息

[>>LRC\(乐山无线电\)](#)