

LP2408LT1G

40V P-Channel Power MOSFET

1. FEATURES

- Extremely low threshold voltage
- We declare that the material of product compliance with RoHS requirements and Halogen Free.

2. APPLICATIONS

- Portable appliances
- High speed switch
- Battery management

3. DEVICE MARKING AND ORDERING INFORMATION

Device	Marking	Shipping
LP2408LT1G	P24	3000/Tape&Reel
LP2408LT3G	P24	10000/Tape&Reel

4. MAXIMUM RATINGS(Ta = 25°C)

Parameter	Symbol	Limits	Unit
Drain–Source Voltage	VDSS	-40	V
Gate–to–Source Voltage – Continuous	VGS	±20	V
Continuous Drain Current	ID	TA = 25°C	-3
		TA = 70°C	-2.3
Pulsed Drain Current	IDM	-12	A

5. THERMAL CHARACTERISTICS

Parameter	Symbol	Limits	Unit
Maximum Power Dissipation	PD	1.3	W
Thermal Resistance, Junction–to–Ambient(Note 1)	RθJA	95	°C/W
Junction and Storage temperature	TJ,Tstg	-55~+150	°C

1. 1-in² 2oz Cu PCB board.

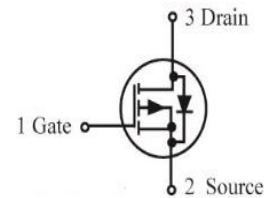
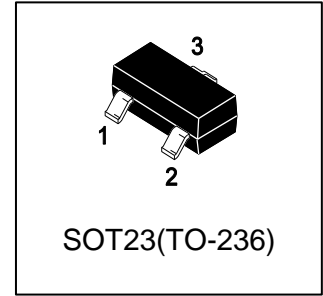

6. ELECTRICAL CHARACTERISTICS (Ta= 25°C)

Characteristic	Symbol	Min.	Typ.	Max.	Unit	
Static						
Drain-Source Breakdown Voltage (VGS = 0 V, ID = -250 μA)	VBRDSS	-40	-	-	V	
Gate Threshold Voltage (VDS = VGS, ID = -250 μA)	VGS(th)	-1	-	-2.2	V	
Drain-Source Leakage Current (VDS = -32 V, VGS = 0V)	IDSS	-	-	-1	μA	
Gate-Body Leakage Current (VGS = ±20 V, VDS = 0 V)	IGSS	-	-	±10	μA	
Static Drain-Source On-State Resistance(Note 2) (VGS = -10 V, ID = -3 A) (VGS = -4.5 V, ID = -2.5 A)	RDS(on)	-	-	60 90	mΩ	
Forward Voltage (IS= -1 A, VGS= 0 V)	VSD	-	-	-1.3	V	
Dynamic						
Input Capacitance (VGS = 0 V, f = 1.0MHz, VDS= -20 V)	Ciss	-	724	-	pF	
Output Capacitance (VGS = 0 V, f = 1.0MHz, VDS= -20 V)	Coss	-	58	-		
Reverse Transfer Capacitance (VGS = 0 V, f = 1.0MHz, VDS= -20 V)	Crss	-	48	-		
Total Gate Charge(10V)	(VDS = -20 V, ID = -3 A)	Qg	-	12	-	nC
Total Gate Charge(4.5V)		Qg	-	6.5	-	
Gate-Source Charge		Qgs	-	1.5	-	
Gate-Drain Charge		Qgd	-	3	-	
Turn-On Delay Time	(VDD = -20 V, RL = 20 Ω, ID = -1 A, RG = 1 Ω, VGEN= -10 V)	td(on)	-	3.5	-	ns
Rise Time		tr	-	2.5	-	
Turn-Off Delay Time		td(off)	-	97	-	
Fall Time		tf	-	43	-	

2. Pulse Test: Pulse Width ≤ 300 μs, Duty Cycle ≤ 2.0%.

7. ELECTRICAL CHARACTERISTICS CURVES

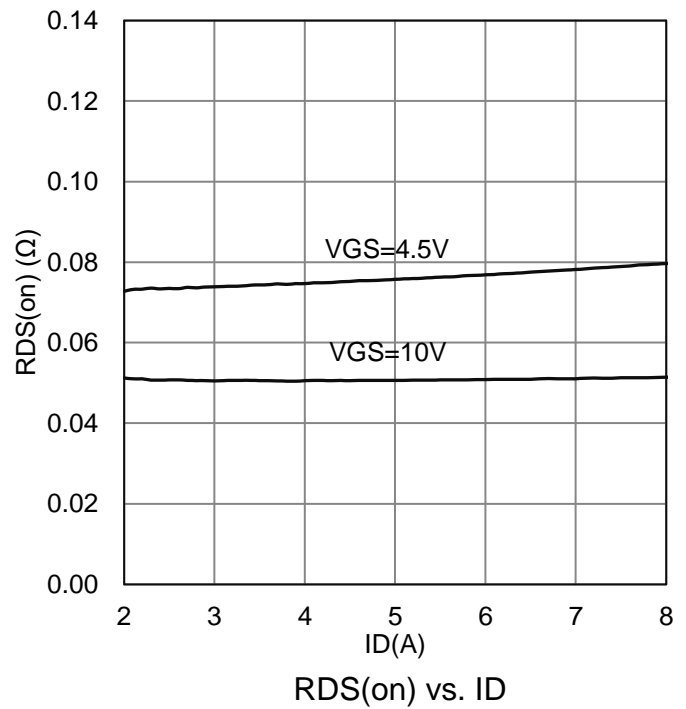
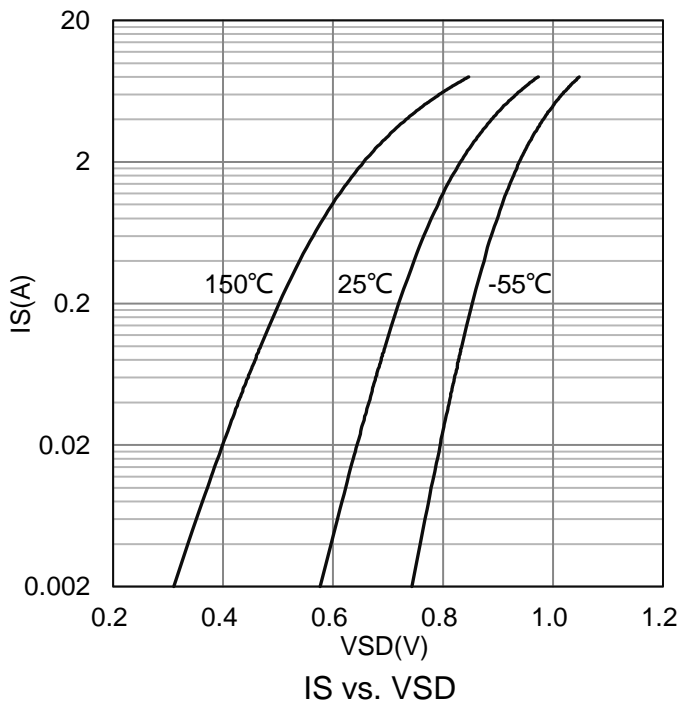
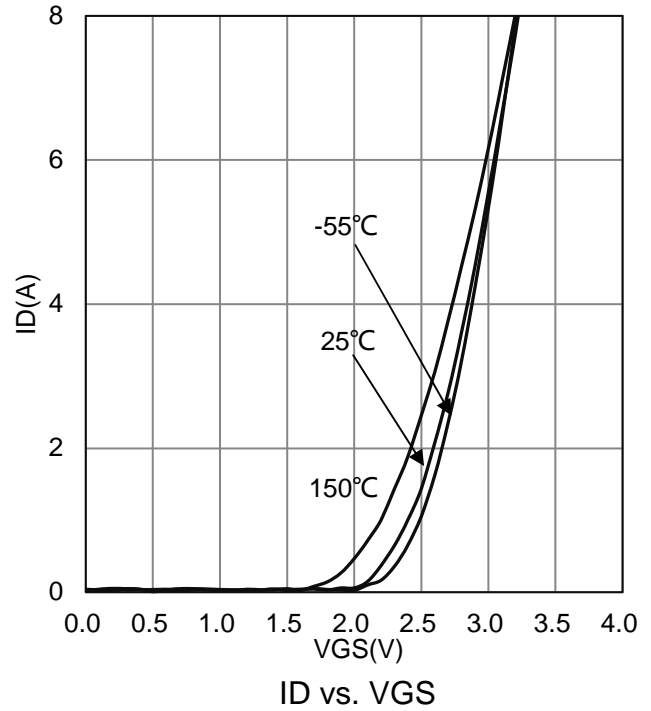
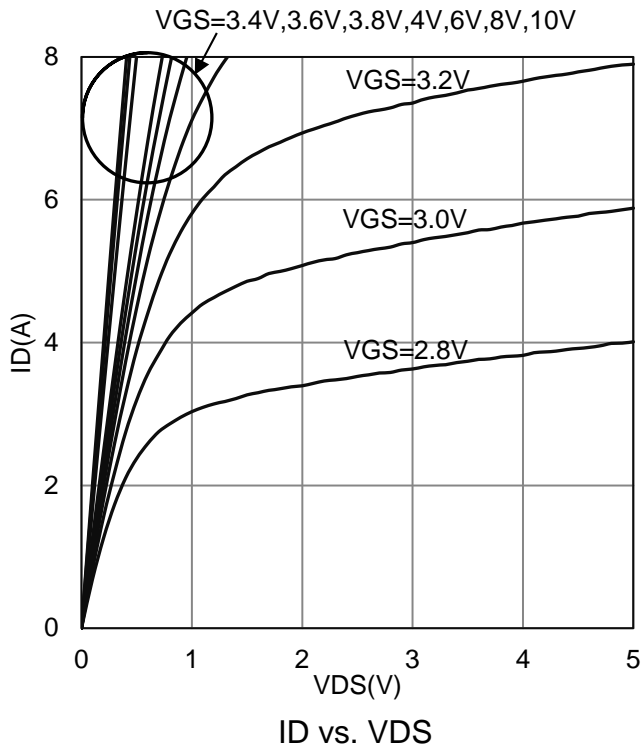

7. ELECTRICAL CHARACTERISTICS CURVES(Con.)

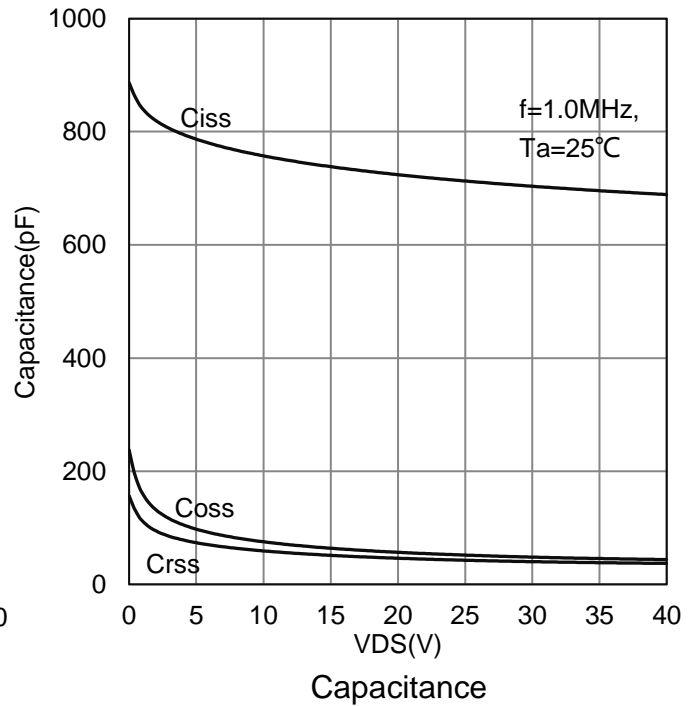
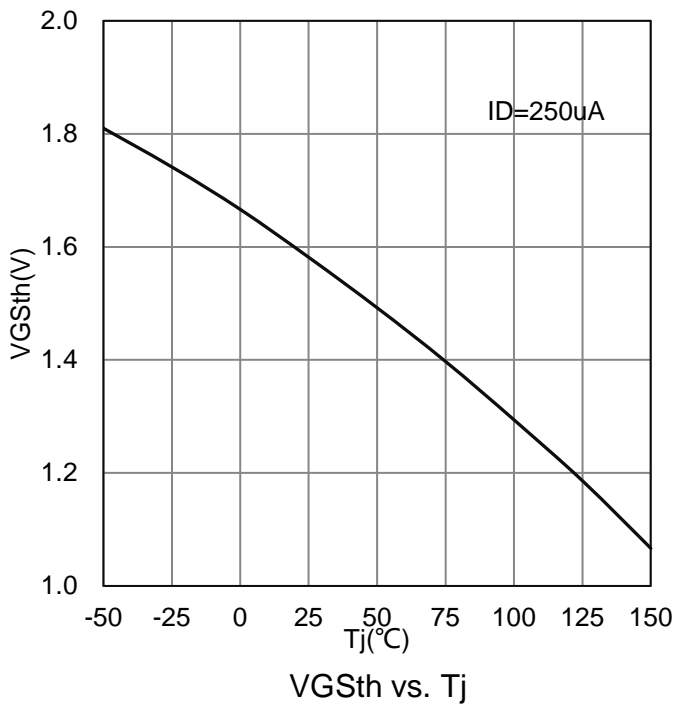
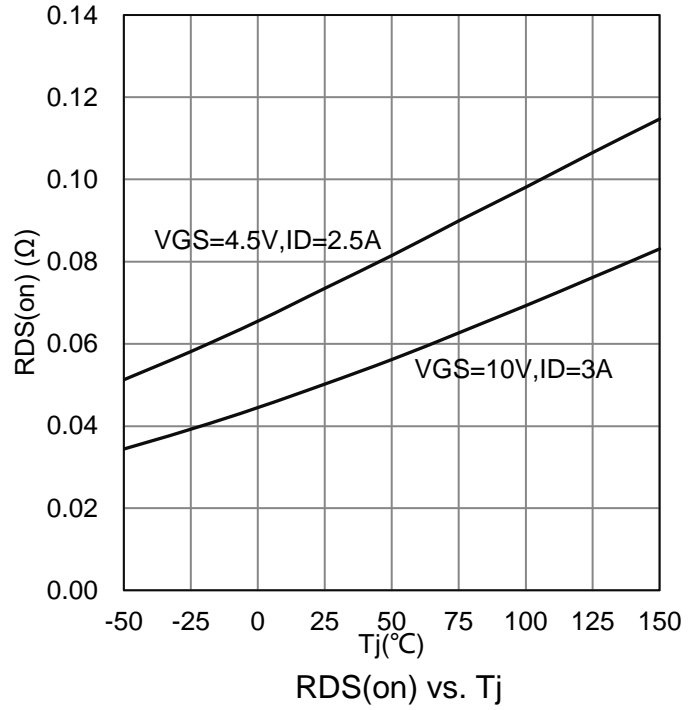
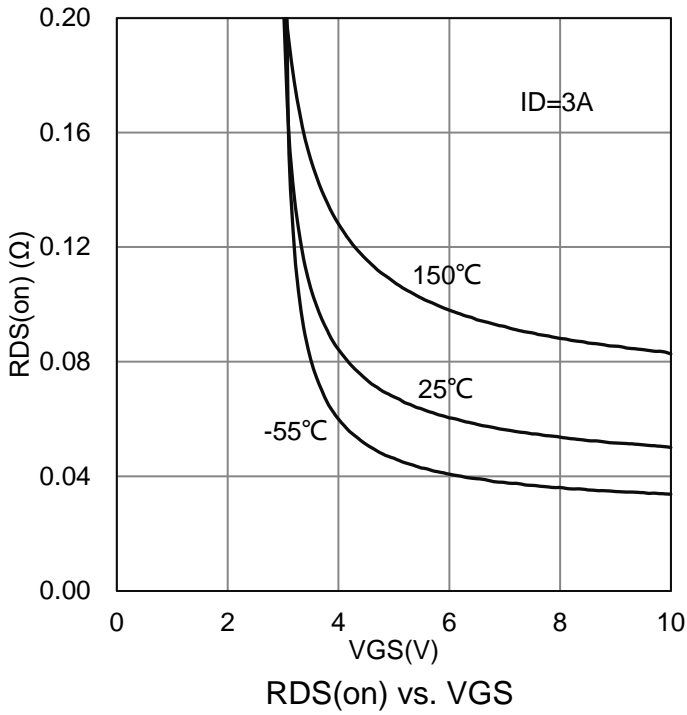

7. ELECTRICAL CHARACTERISTICS CURVES(Con.)

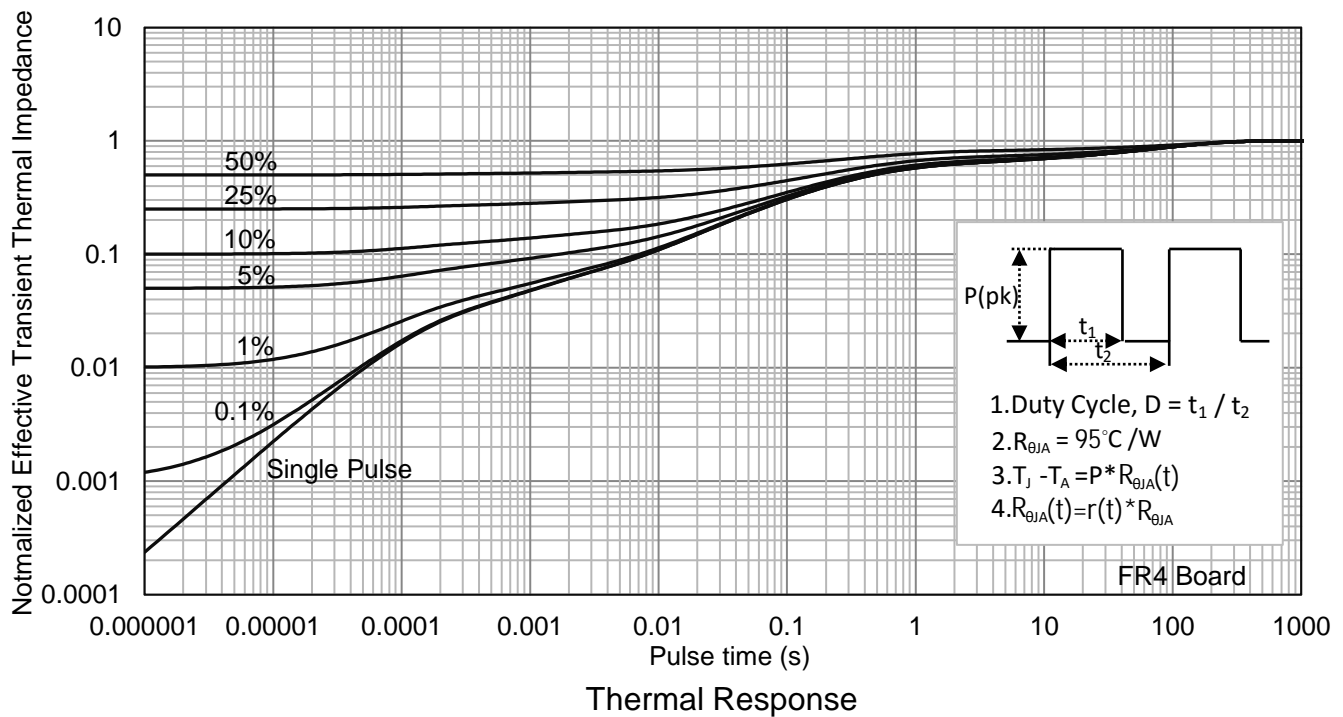
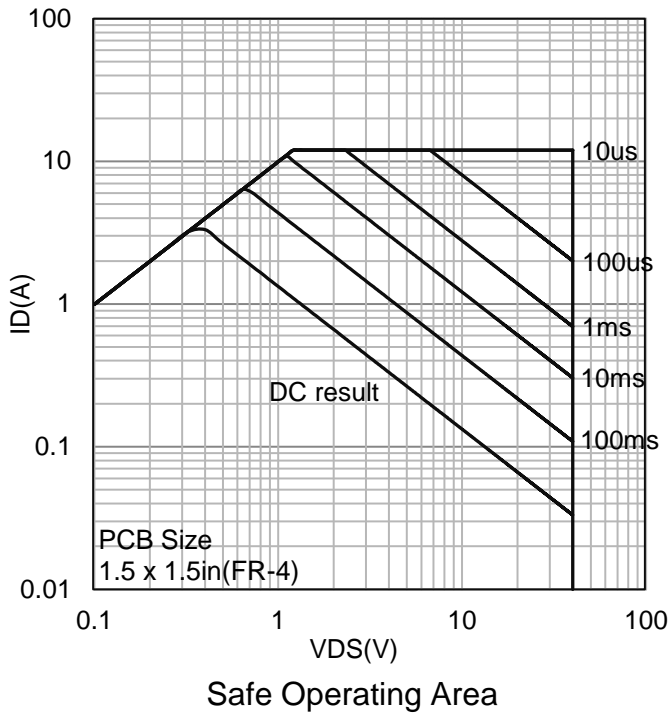

8. OUTLINE AND DIMENSIONS

Notes:

1. DIMENSIONING AND TOLERANCING PER ANSI Y14.5M, 1982.
2. CONTROLLING DIMENSION: MILLIMETERS.
3. MAXIMUM LEAD THICKNESS INCLUDES LEAD FINISH. MINIMUM LEAD THICKNESS IS THE MINIMUM THICKNESS OF BASE MATERIAL.
4. DIMENSIONS D AND E DO NOT INCLUDE MOLD FLASH, PROTRUSIONS OR GATE BURRS.

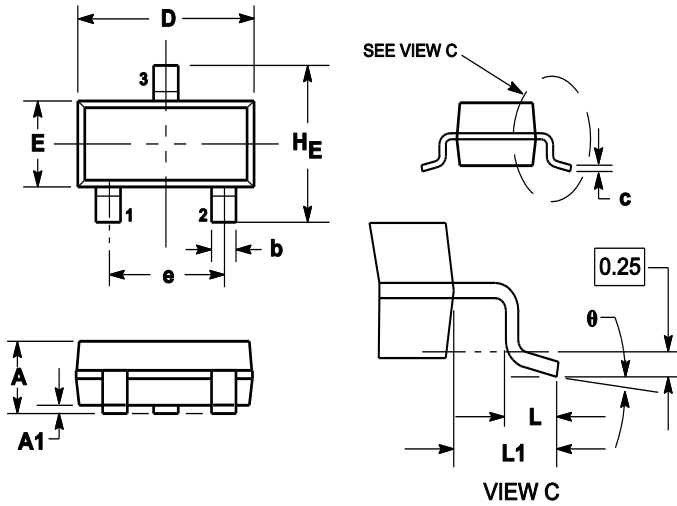

DIM	MILLIMETERS			INCHES		
	MIN	NOM	MAX	MIN	NOM	MAX
A	0.89	1	1.11	0.035	0.04	0.044
A1	0.01	0.06	0.1	0.001	0.002	0.004
b	0.37	0.44	0.5	0.015	0.018	0.02
c	0.09	0.13	0.18	0.003	0.005	0.007
D	2.80	2.9	3.04	0.11	0.114	0.12
E	1.20	1.3	1.4	0.047	0.051	0.055
e	1.78	1.9	2.04	0.07	0.075	0.081
L	0.10	0.2	0.3	0.004	0.008	0.012
L1	0.35	0.54	0.69	0.014	0.021	0.029
HE	2.10	2.4	2.64	0.083	0.094	0.104
theta	0°	---	10°	0°	---	10°

9. SOLDERING FOOTPRINT

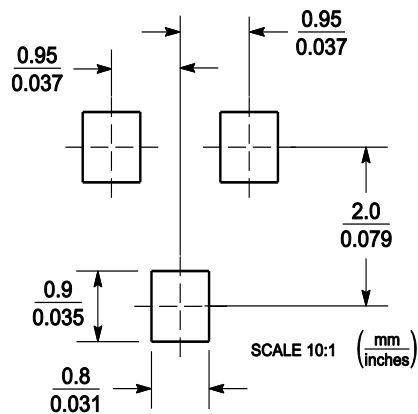

DISCLAIMER

- Curve guarantee in the specification. The curve of test items with electric parameter is used as quality guarantee. The curve of test items without electric parameter is used as reference only.
- Before you use our Products for new Project, you are requested to carefully read this document and fully understand its contents. LRC shall not be in any way responsible or liable for failure, malfunction or accident arising from the use of any LRC's Products against warning, caution or note contained in this document.
- All information contained in this document is current as of the issuing date and subject to change without any prior notice. Before purchasing or using LRC's Products, please confirm the latest information with a LRC sales representative.

单击下面可查看定价，库存，交付和生命周期等信息

[>>LRC\(乐山无线电\)](#)