

LBTN560Y3T1G

S-LBTN560Y3T1G

NPN transistor

1. FEATURES

- Low collector-emitter saturation voltage.
- High collector current capability.
- High collector current gain.
- High efficiency due to less heat generation.
- Smaller required Printed-Circuit Board (PCB) area.
- We declare that the material of product compliance with RoHS requirements and Halogen Free.
- S-prefix for automotive and other applications requiring unique site and control change requirements; AEC-Q101 qualified and PPAP capable.

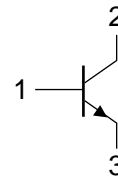
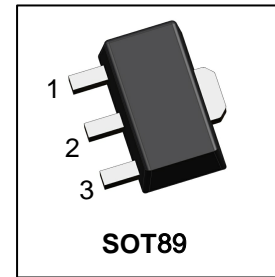

2. DEVICE MARKING AND ORDERING INFORMATION

Device	Marking	Shipping
LBTN560Y3T1G	6NP	1000/Tape&Reel

3. MAXIMUM RATINGS(Ta = 25°C)

Parameter	Symbol	Limits	Unit
Collector–Emitter Voltage	V _{CEO}	60	V
Collector–Base Voltage	V _{CBO}	150	V
Emitter–Base Voltage	V _{EBO}	7	V
Collector Current — Continuous	I _C	5	A
Peak Collector Current (tp ≤ 1 ms)	I _{CM}	20	A
Junction and Storage temperature	T _J , T _{stg}	-55~+150	°C

4. THERMAL CHARACTERISTICS

Parameter	Symbol	Limits	Unit
Total Device Dissipation, FR-4 Board (Note 1) @ TA = 25°C Derate above 25°C	PD	550 4.4	mW mW/°C
Thermal Resistance, Junction–to–Ambient	R _{θJA}	225	°C/W

1.PCB Size:30.0mm×25.0mm×1.6mm,FR-4 Board;

5. ELECTRICAL CHARACTERISTICS (Ta= 25°C)
OFF CHARACTERISTICS

Characteristic	Symbol	Min.	Typ.	Max.	Unit
Collector–Emitter Breakdown Voltage (IC = 10 mA, IB = 0)	VBR(CEO)	60	-	-	V
Collector–Base Breakdown Voltage (IC = 100 μA, IE = 0)	VBR(CBO)	150	-	-	V
Emitter–Base Breakdown Voltage (IE = 100 μA, IC = 0)	VBR(EBO)	7	-	-	V
Collector Cutoff Current (VCB = 150V, IE = 0 A)	ICBO	-	-	30	nA
Emitter CutOff Current (VEB = 7 V, IC = 0 A)	IEBO	-	-	30	nA
Collector-Emitter cutoff Current (VCE= 60V, IB=0)	ICEO	-	-	10	μA

ON CHARACTERISTICS (Note 2)

DC Current Gain (VCE = 1 V, IC = 10 mA) (VCE = 1 V, IC = 2 A) (VCE = 1 V, IC = 5 A)	HFE	100 100 55	200 200 105	- 300 -	
Collector–Emitter Saturation Voltage (IC = 0.1 A, IB = 5 mA) (IC = 1 A, IB = 100 mA) (IC = 1 A, IB = 50 mA) (IC = 2 A, IB = 50 mA) (IC = 6 A, IB = 300 mA)	VCE(sat)	- - - - -	17 35 40 90 170	30 55 65 125 230	mV
Base–Emitter Saturation Voltage (IC = 6 A, IB = 300 mA)	VBE(sat)	-	0.97	1.1	V
Base-Emitter Turn-On Voltage (VCE = 1 V, IC = 6 A)	VBE(on)	-	0.91	1.05	V

SMALL–SIGNAL CHARACTERISTICS

Transitional Frequency (VCE = 10 V, IC = 100 mA, f = 50 MHz)	fT	-	130	-	
Output capacitance (VCB = 10 V, f = 1 MHz)	Cobo	-	31	-	pF

SWITCHING CHARACTERISTICS

Switching times (IC = 1A, VCC = 10V, IB1 = IB2 = 100mA)	td(on)	-	42	-	ns
Switching times (IC = 1A, VCC = 10V, IB1 = IB2 = 100mA)	td(off)	-	760	-	

2.Pulse Test: Pulse Width ≤300 μs, Duty Cycle ≤2.0%.

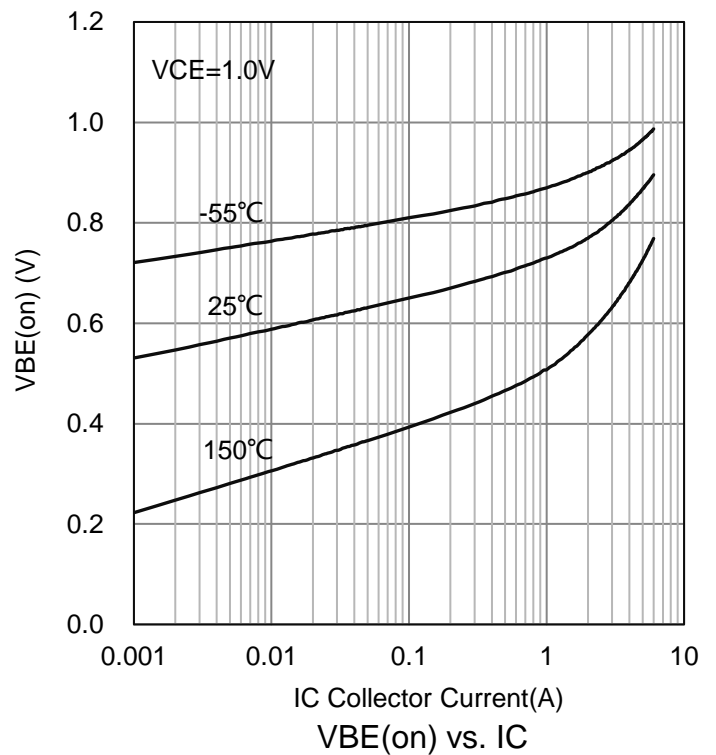
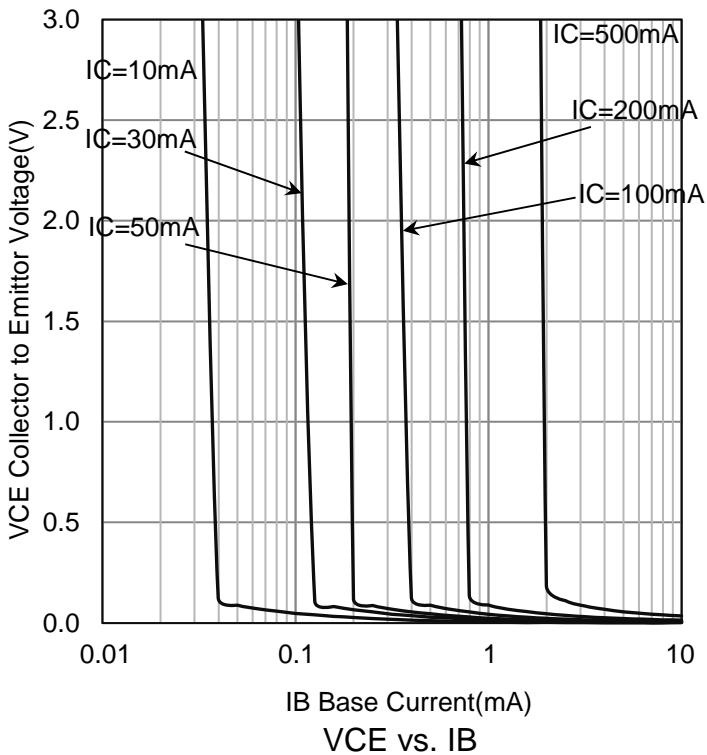
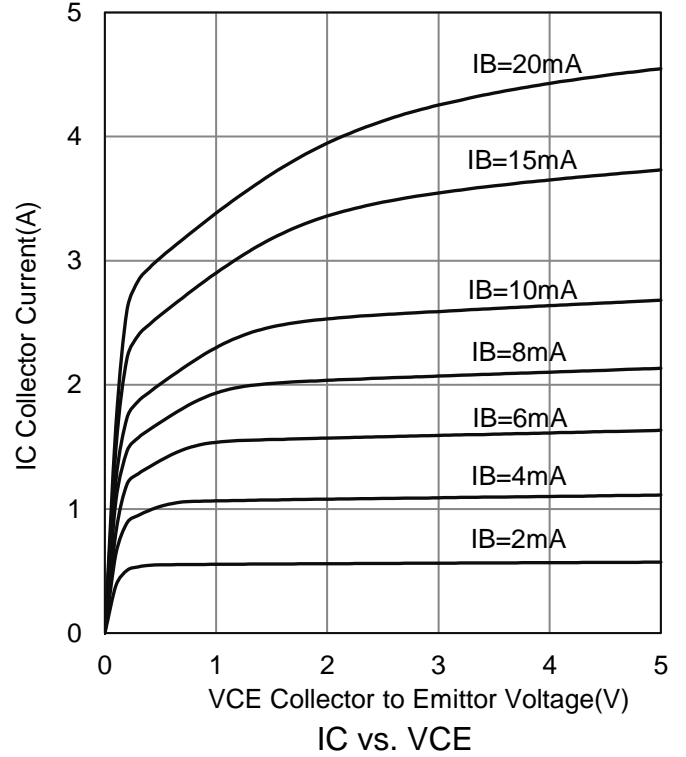
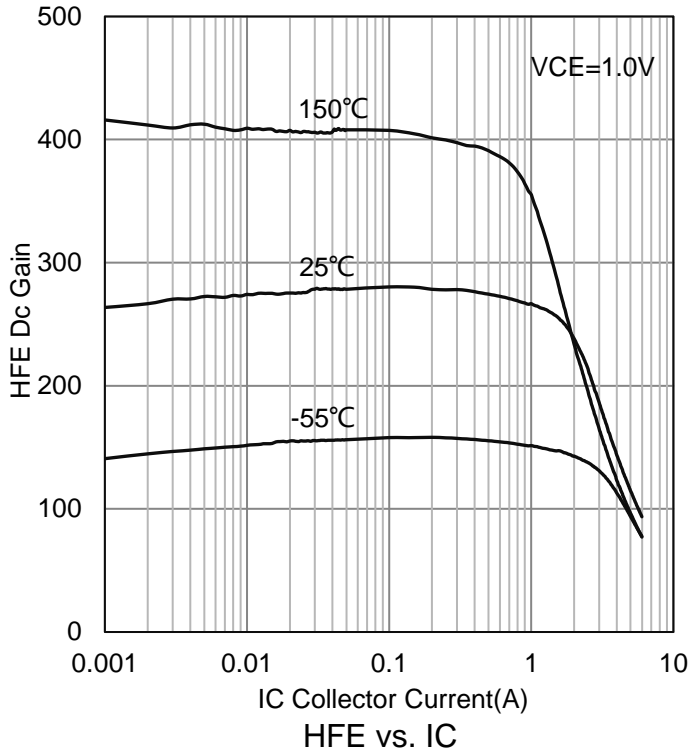
6.ELECTRICAL CHARACTERISTICS CURVES

6.ELECTRICAL CHARACTERISTICS CURVES(Con.)

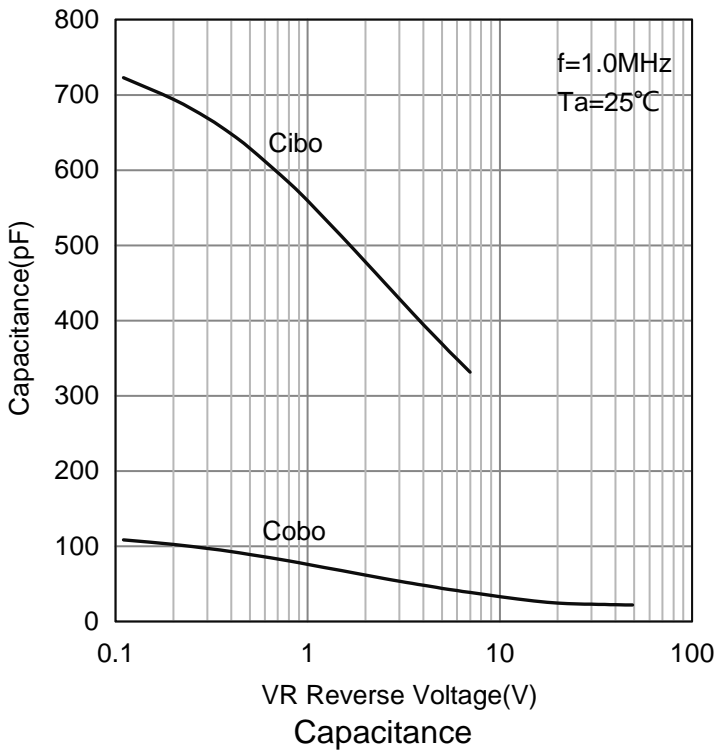
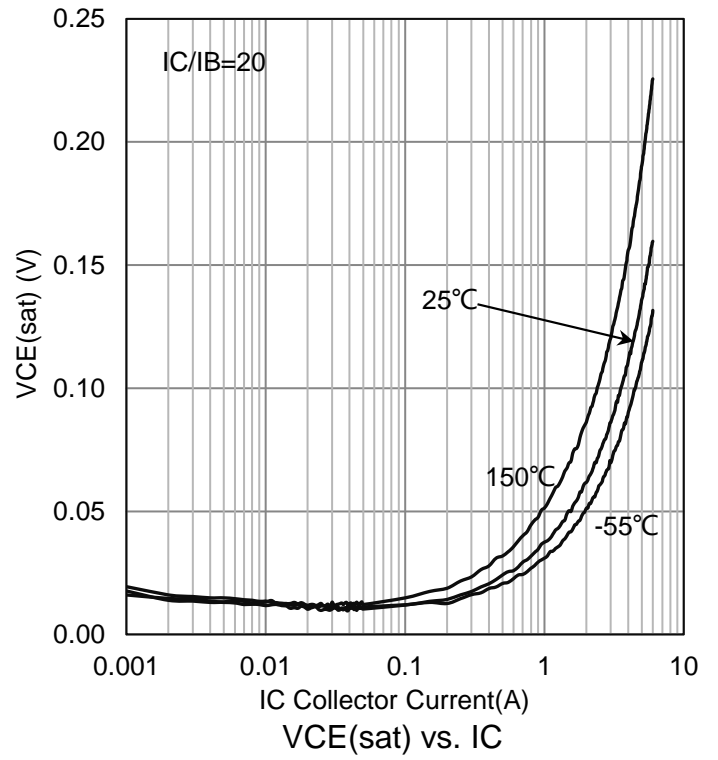
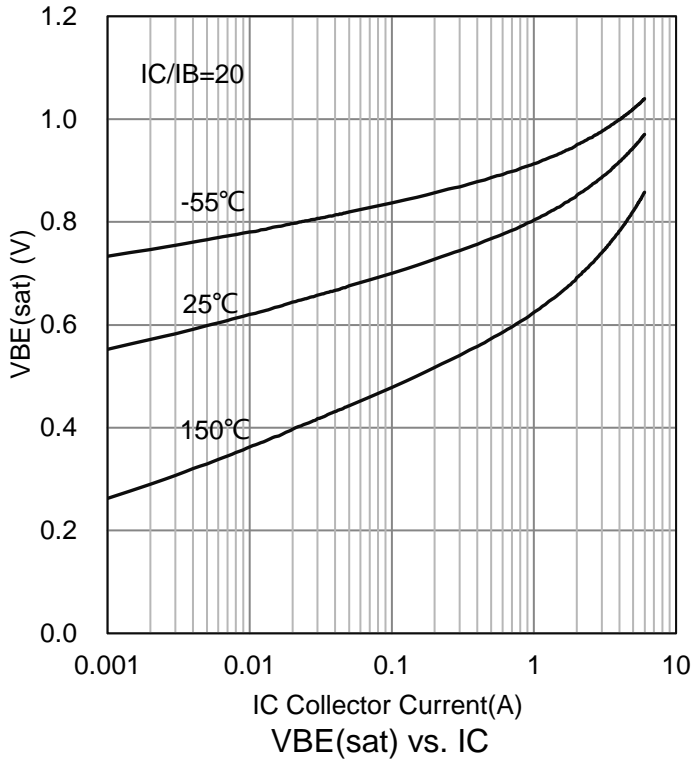

7.OUTLINE AND DIMENSIONS

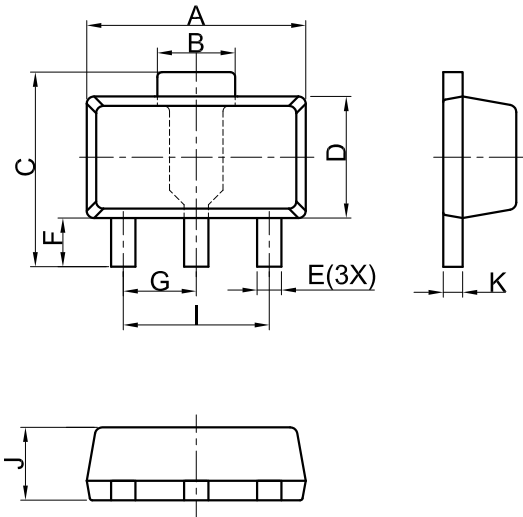

SOT89			
DIM	MIN	NOR	MAX
A	4.30	4.50	4.70
B	1.40	1.60	1.80
C	3.90	4.00	4.25
D	2.30	2.50	2.70
E	0.40	0.50	0.58
F	0.90	1.00	1.20
G	1.50 BSC		
I	3.00 BSC		
J	1.40	1.50	1.60
K	0.34	0.40	0.50
All Dimensions in mm			

GENERAL NOTES

1. Top package surface finish Ra0.4±0.2um
2. Bottom package surface finish Ra0.7±0.2um
3. Side package surface finish Ra0.4±0.2um
4. Protrusion or Gate Burrs shall not exceed 0.10mm per side.

8.SOLDERING FOOTPRINT

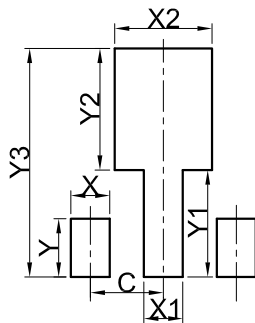

SOT89	
DIM	(mm)
X	0.80
Y	1.20
X1	0.80
Y1	2.20
X2	2.00
Y2	2.50
C	1.50
Y3	4.70

DISCLAIMER

- Curve guarantee in the specification. The curve of test items with electric parameter is used as quality guarantee. The curve of test items without electric parameter is used as reference only.
- Before you use our Products for new Project, you are requested to carefully read this document and fully understand its contents. LRC shall not be in any way responsible or liable for failure, malfunction or accident arising from the use of any LRC's Products against warning, caution or note contained in this document.
- All information contained in this document is current as of the issuing date and subject to change without any prior notice. Before purchasing or using LRC's Products, please confirm the latest information with a LRC sales representative.

单击下面可查看定价，库存，交付和生命周期等信息

[>>LRC\(乐山无线电\)](#)