

LN2294LT1G

110V N-Channel Enhancement-Mode MOSFET

1. FEATURES

- $V_{DS} = 110V$
- $R_{DS(ON)} \leq 200 m\Omega @ V_{GS} = 10V, I_D = 3A$
- $R_{DS(ON)} \leq 260 m\Omega @ V_{GS} = 4.5V, I_D = 1A$
- Super high density cell design for extremely low $R_{DS(ON)}$.
- Exceptional on-resistance and maximum DC current capability.
- We declare that the material of product compliance with RoHS requirements and Halogen Free.

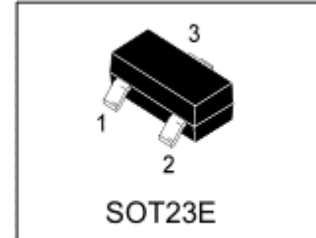

2. APPLICATIONS

- Power Management in Note book
- DC/DC Converter
- Load Switch

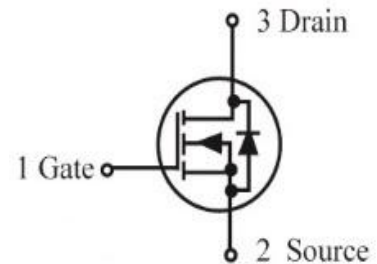

3. DEVICE MARKING AND ORDERING INFORMATION

Device	Marking	Shipping
LN2294LT1G	N4L	3000/Tape&Reel

4. MAXIMUM RATINGS($T_a = 25^\circ C$)

Parameter	Symbol	Limits	Unit
Drain-Source Voltage	V_{DS}	110	V
Gate-to-Source Voltage – Continuous	V_{GS}	± 20	V
Drain Current			
– Continuous $T_a = 25^\circ C$	I_D	3	A
– Pulsed	I_{DM}	10	

5. THERMAL CHARACTERISTICS

Parameter	Symbol	Limits	Unit
Maximum Power Dissipation	PD	1.25	W
Thermal Resistance, Junction-to-Ambient	$R_{\theta JA}$	100	$^\circ C/W$
Junction and Storage temperature	T_J, T_{stg}	$-55 \sim +150$	$^\circ C$

6. ELECTRICAL CHARACTERISTICS (Ta= 25°C)
STATIC

Characteristic	Symbol	Min.	Typ.	Max.	Unit
Drain–Source Breakdown Voltage (VGS = 0V, ID = 250μA)	V(BR)DSS	110	-	-	V
Gate Threshold Voltage (VDS = VGS, ID = 250μA)	VGS(th)	1.0	-	3.0	V
Gate–Body Leakage (VDS = 0 V, VGS = ±20 V)	IGSS	-	-	±100	nA
Zero Gate Voltage Drain Current (VDS=100 V, VGS=0 V)	IDSS	-	-	1	μA
Static Drain–Source On–State Resistance (VGS = 10 V, ID = 3 A) (VGS = 4.5 V, ID = 1 A)	RDS(on)	- -	160 200	200 260	mΩ
Forward Voltage (VGS = 0 V, IS = 6.5 A)	VSD	-	0.9	1.3	V

DYNAMIC

Total Gate Charge	(VDS =50V, VGS =5V, ID =6.5A)	Qg	-	8.2	-	nC
Gate–Source Charge		Qgs	-	4.3	-	
Gate–Drain Charge		Qgd	-	5.3	-	
Input Capacitance	(VDS =25V, VGS =0V, f=1MHz)	Ciss	-	396	-	pF
Output Capacitance		Coss	-	47	-	
Reverse Transfer Capacitance		Crss	-	30	-	
Turn-On Delay Time	(VDD =50V, RL =50Ω, VGEN =10V, RG =2.5Ω)	td(on)	-	9.6	-	ns
Rise Time		tr	-	4.2	-	
Turn-Off Delay Time		td(off)	-	25	-	
Fall Time		tf	-	3.2	-	

Note 1:Pulse Test: Pulse Width ≤300 μs, Duty Cycle ≤2.0%.

7. ELECTRICAL CHARACTERISTICS CURVES

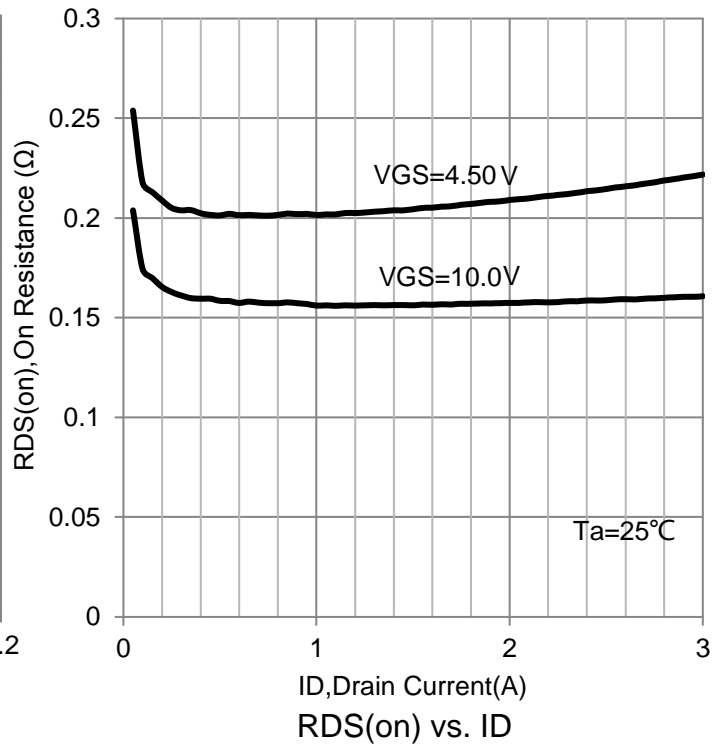
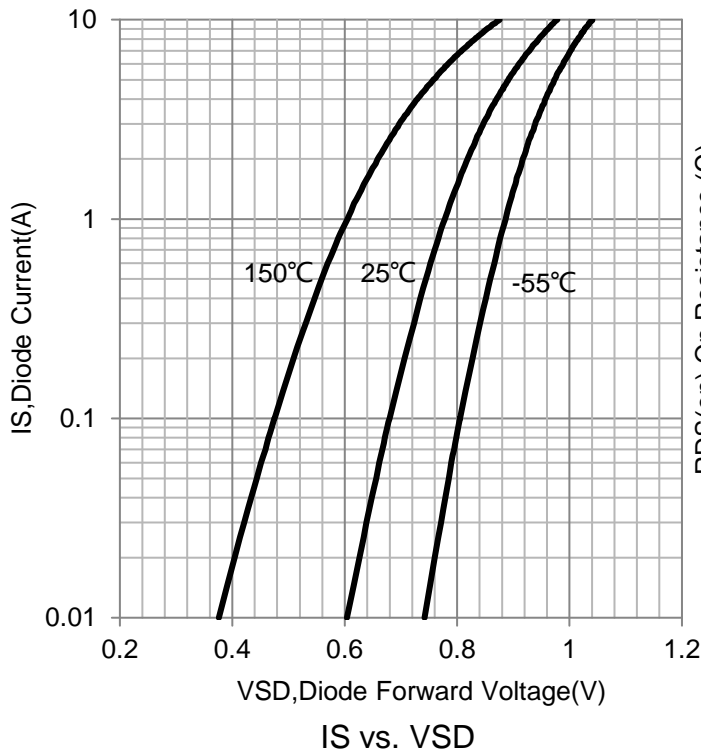
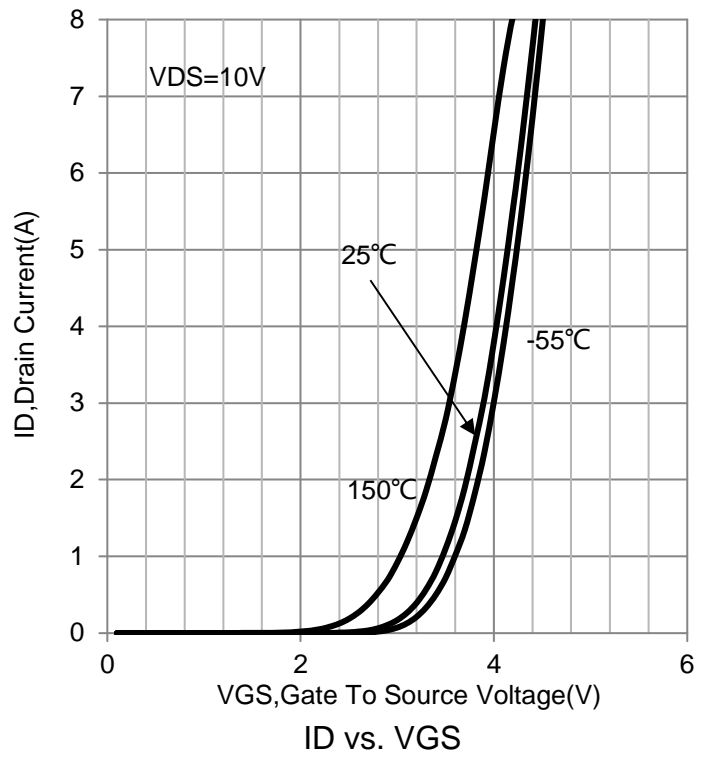
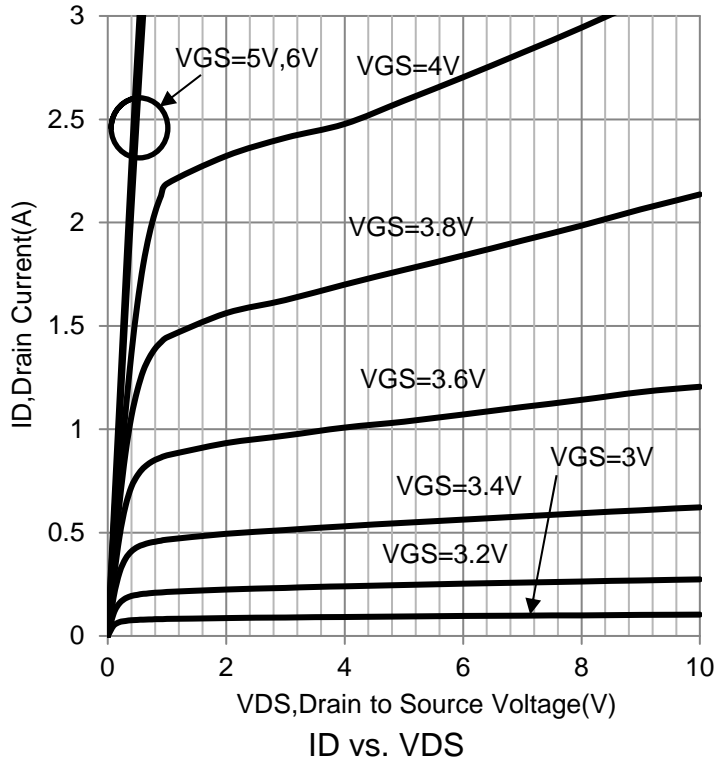

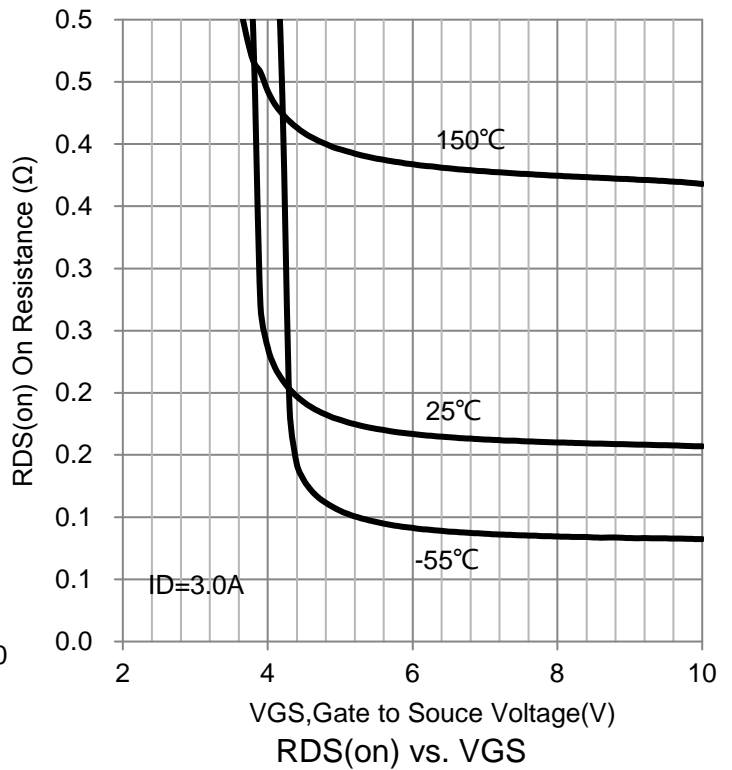
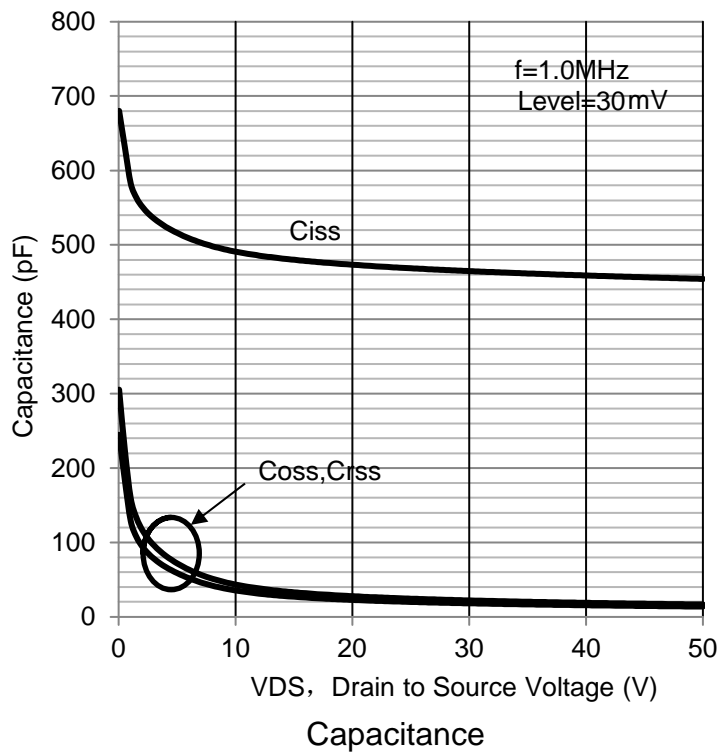
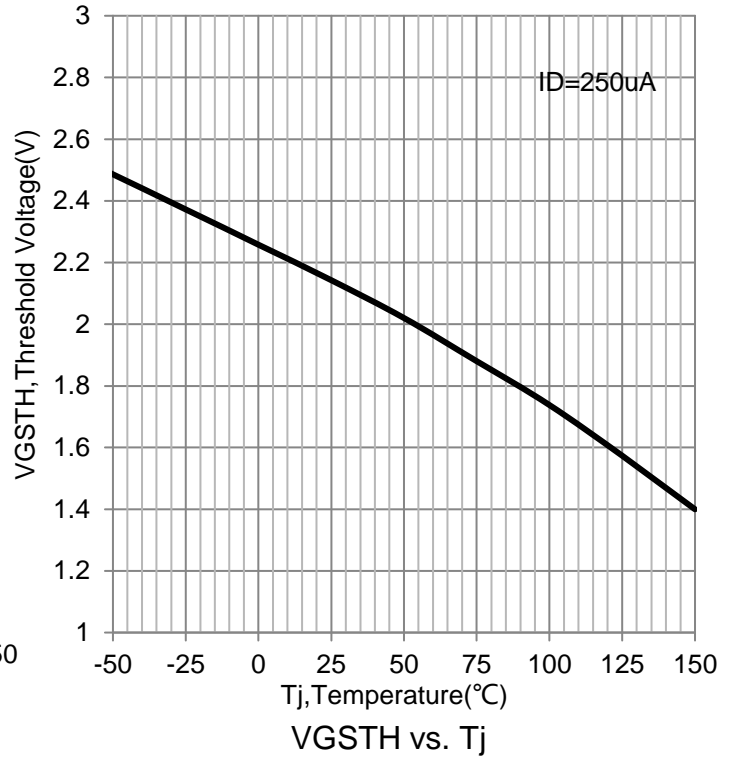
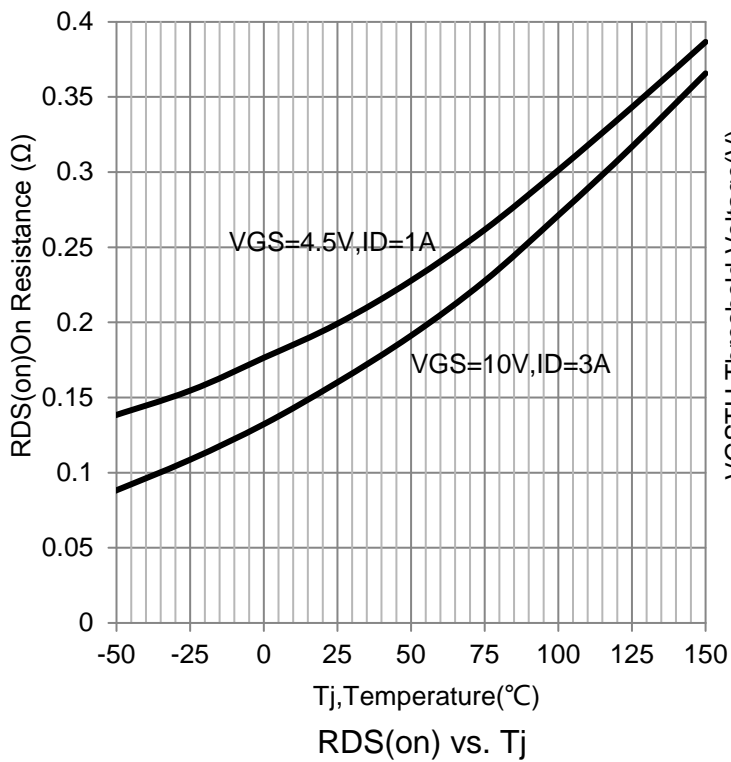
7.ELECTRICAL CHARACTERISTICS CURVES(Con.)

8. OUTLINE AND DIMENSIONS

SOT-23E

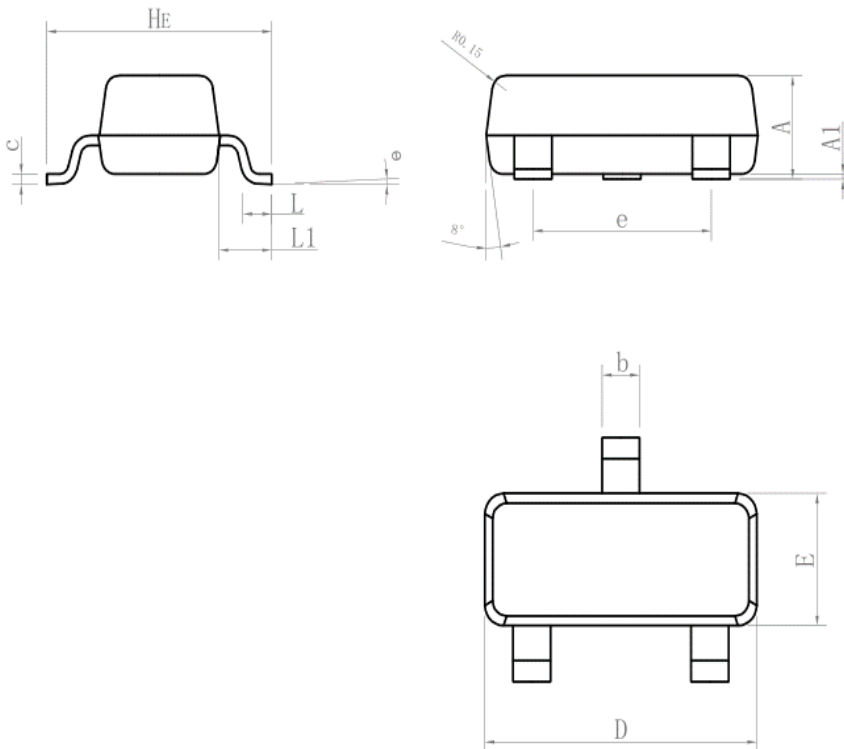

SOT23E			
DIM	MIN	NOR	MAX
A	0.90	1.00	1.10
A1	0.01	0.06	0.10
b	0.30	0.40	0.50
c	0.10	0.15	0.20
D	2.80	2.90	3.00
E	1.20	1.30	1.40
e	1.80	1.90	2.00
L	0.20	0.40	0.60
L1	0.45	0.55	0.65
H_E	2.20	2.40	2.60
θ	0°	-	10°
All Dimensions in mm			

GENERAL NOTES

1. Top package surface finish $Ra0.4 \pm 0.2\mu m$
2. Bottom package surface finish $Ra0.7 \pm 0.2\mu m$
3. Side package surface finish $Ra0.4 \pm 0.2\mu m$

9. SOLDERING FOOTPRINT

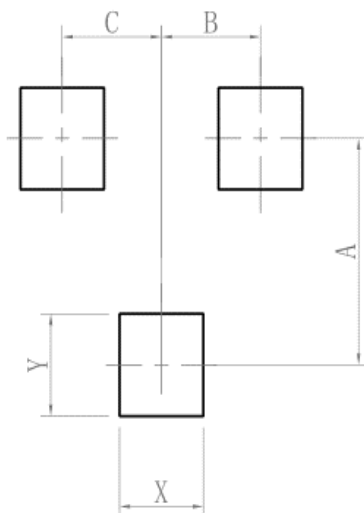

SOT23E	
DIM	(mm)
X	0.80
Y	0.90
A	2.00
B	0.95
C	0.95

单击下面可查看定价，库存，交付和生命周期等信息

[>>LRC\(乐山无线电\)](#)